



# Complementary technical information



Catalogue 2019  
Low Voltage



# Green Premium™

Endorsing eco-friendly products in the industry



## Green Premium™ Product

Green Premium is the only label that allows you to effectively develop and promote an environmental policy whilst preserving your business efficiency. This ecolabel guarantees compliance with up-to-date environmental regulations, but it does more than this.

Over 75% of Schneider Electric manufactured products have been awarded the Green Premium ecolabel



Discover what we mean by green ...

**Check your products!**

Schneider Electric's Green Premium ecolabel is committed to offering transparency, by disclosing extensive and reliable information related to the environmental impact of its products:

### RoHS

Schneider Electric products are subject to RoHS requirements at a worldwide level, even for the many products that are not required to comply with the terms of the regulation. Compliance certificates are available for products that fulfil the criteria of this European initiative, which aims to eliminate hazardous substances.

### REACH

Schneider Electric applies the strict REACH regulation on its products at a worldwide level, and discloses extensive information concerning the presence of SVHC (Substances of Very High Concern) in all of its products.

### PEP: Product Environmental Profile

Schneider Electric publishes complete set of environmental data, including carbon footprint and energy consumption data for each of the lifecycle phases on all of its products, in compliance with the ISO 14025 PEP ecopassport program. PEP is especially useful for monitoring, controlling, saving energy, and/or reducing carbon emissions.

### EoLI: End of Life Instructions

Available at the click of a button, these instructions provide:

- Recyclability rates for Schneider Electric products.
- Guidance to mitigate personnel hazards during the dismantling of products and before recycling operations.
- Parts identification for recycling or for selective treatment, to mitigate environmental hazards/ incompatibility with standard recycling processes.

# General contents

## Complementary technical information

Coordination for electrical distribution

A

Coordination for motor circuits

B

Use of LV switches

C

Protection of LV/LV transformers and capacitors

D

Coordination with electrical busbar trunking

E

For more information  
on this guide



**Coordination for electrical distribution****A-1**

Coordination between circuit breakers .....	A-2
<b>Selectivity table</b>	
220-240/380-415 V AC .....	A-15
Ue ≤ 440 V AC .....	A-69
Ue: 24-48-60 V DC .....	A-106
Ue: 110, 125 V DC .....	A-121
Ue: 220, 250 V DC .....	A-131
<b>Selectivity with fuses - Introduction</b> .....	<b>A-139</b>
<b>Selectivity tables with fuses</b> .....	<b>A-144</b>
<b>Cascading (or Back-up protection)</b> .....	<b>A-153</b>
<b>Cascading tables</b> .....	
Ue: 380-415 V AC (Ph/N 220-240 V AC) .....	A-158
Ue: 440 V AC .....	A-162
Ue: 220-240 V AC .....	A-166
<b>Selectivity enhanced by cascading</b> .....	
Ue: 380-415 V AC (Ph/N 220-240 V AC) .....	A-171
Ue: 440 V AC .....	A-177
Ue: 220-240 V AC (Ph/N 110-130 V AC) .....	A-183

**Coordination for motor circuits****B-1**

Motor protection selectivity .....	B-1
Motor protection cascading .....	B-19
Selectivity enhanced by cascading .....	B-22
Motor protection coordination .....	B-27
<b>Type 2 coordination (IEC 60947-4-1)</b>	
Ue: 220-240 V AC .....	B-36
Ue: 380-400 V AC .....	B-38
Ue: 415 V AC .....	B-41
Ue: 440 V AC .....	B-44
Ue: 690 V AC .....	B-47
<b>Type 1 coordination (IEC 60947-4-1)</b> .....	<b>B-52</b>
<b>Type 1 coordination (IEC 60947-4-1) for AC1 Utilisation category: non-inductive or slightly inductive loads</b> ..	<b>B-60</b>
<b>Protection of motor circuits with fuses: introduction</b>	<b>B-61</b>
<b>Type 2 coordination (IEC 60947-4-1)</b>	
Ue: 380-415 V AC .....	B-67
Ue: 440 V AC .....	B-69
Ue: 500 V AC .....	B-71
Ue: 525-550 V AC .....	B-73
Ue: 660-690 V .....	B-75

<b>Use of LV switches</b>	<b>C-1</b>
Use of LV switches .....	C-1
Choosing a Schneider Electric switch-disconnector.	C-4
Switch-disconnector - Circuit breaker coordination ..	C-8
Switch-disconnector - Fuse coordination .....	C-32
<b>Protection of LV/LV transformers and capacitors</b>	<b>D-2</b>
Protection of LV/LV transformers and capacitors .....	D-2
<b>Coordination with electrical busbar trunking</b>	<b>E-2</b>
Coordination tables between circuit breaker and Canalis electrical busbar trunking .....	E-2
Ue: 220 or 240 V AC Ph/N .....	E-4
Ue: 380-415 V AC .....	E-5
Ue: 660-690 V AC .....	E-12

# Coordination between circuit breakers

## Selectivity

A



EO02487-37 eps

Selectivity of over-current protection is covered by circuit breakers standards: IEC 60947-2 Annex A and IEC 60898-1 Annex D.  
 Selectivity of residual current protection is covered by IEC 60364 series and product standards IEC 60947-2 Annex B and M, IEC 61009-1.

### Selectivity (discrimination)

#### Principles of Selectivity

Selectivity is achieved by overcurrent and earth fault protective devices if a fault condition, occurring at any point in the installation, is cleared by the protective device located immediately upstream of the fault, while all other protective devices remain unaffected.

Selectivity is required for installation supplying critical loads where one fault on one circuit shall not cause the interruption of the supply of other circuits. In IEC 60364 series it is mandatory for installation supplying safety services. (IEC60364-5-56 2009 560.7.4). Selectivity may also be required by some local regulation or for some special application like :

- Medical location
- Marine
- High-rise building

Selectivity is highly recommended where continuity of supply is critical due to the nature of the loads.

- Data center
- Infrastructure (tunnel, airport...)
- Critical process

From installation point of view: Selectivity is achieved when the maximum short-circuit current at a point of installation is below selectivity limit of the circuit breakers supplying this point of installation. Selectivity shall be checked for all circuits supplied by one source and for all type of fault:

- Overload
- Short-circuit
- Earth fault

When system can be supplied by different sources (Grid or generator set for instance) selectivity shall be checked in both cases.

Selectivity between two circuit breakers may be

- Total : up to the breaking capacity of the downstream circuit breaker
- Partial : up to a specified value according to circuit breakers characteristics

Different solution are provided to achieve selectivity based on:

- Current
- Time
- Energy
- Logic

DB430717 eps

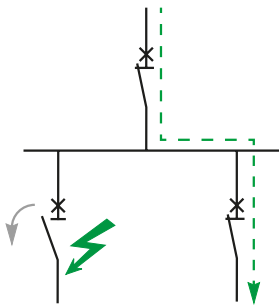

Selectivity is essential to ensure continuity of supply and fast fault localization.

#### Current based selectivity:

This method is realized by setting successive tripping thresholds at stepped levels, from downstream circuits (lower settings) towards the source (higher settings). Selectivity is total or partial, depending on particular conditions, as noted above.

#### Time based selectivity

This method is implemented by adjusting the time-delayed tripping units, such that downstream relays have the shortest operating times, with progressively longer delays towards the source. In the two-level arrangement shown, upstream circuit breaker A is delayed sufficiently to ensure total selectivity with B (for example: Masterpact with electronic trip unit).

Selectivity category B circuit breakers are designed for time based selectivity, the selectivity limit will be the upstream short time withstand value (Icw)

FigH50 eps

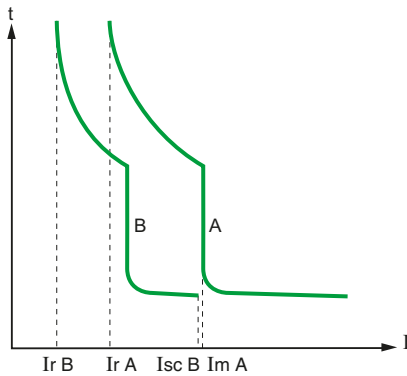

Total selectivity between CBs A and B.

# Coordination between circuit breakers

## Selectivity

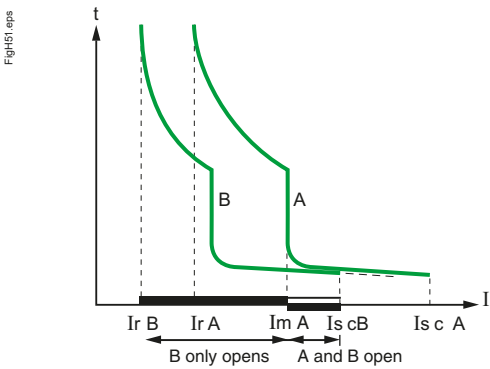

Partial selectivity between CBs A and B

### Selectivity based on a combination of the two previous methods

A time-delay added to a current level scheme can improve the overall selectivity performance.

The upstream CB has two magnetic tripping thresholds:

- Im A: delayed magnetic trip or short-delay electronic trip
- Ii: instantaneous trip

Selectivity is total if  $I_{sc B} < I_i$  (instantaneous).

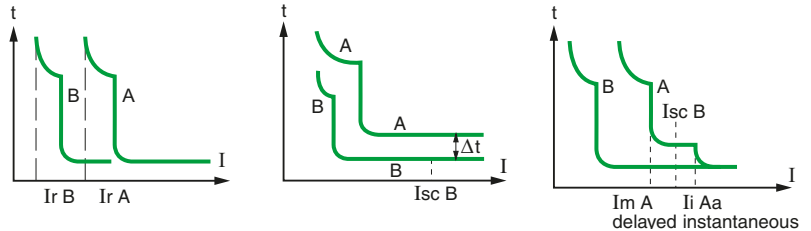

Current based selectivity, Time based selectivity, Combination of both

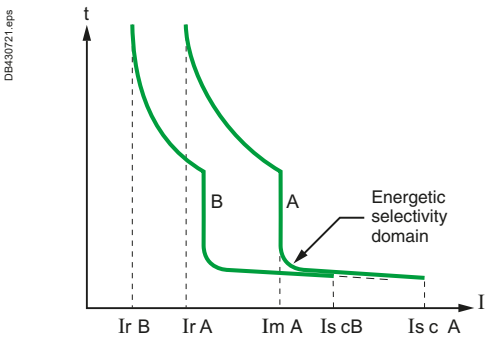

Energetic based selectivity.

### Protection against high level short-circuit currents: Selectivity based on arc-energy levels

Where time versus current curves are superposed selectivity is possible with limiter circuit breaker when they are properly coordinated.

Principle: When a very high level short-circuit current is detected by the two circuit breakers A and B, their contacts open simultaneously. As a result, the current is highly limited.

- The very high arc-energy at level B induces the tripping of circuit breaker B
- Then, the arc-energy is limited at level A and is not sufficient to induce the tripping of A

This approach requires an accurate coordination of limitation levels and tripping energy levels. It's implemented inside the Compact NSX range (current limiting circuit breaker), and between compact NSX and acti 9 range. This solution is the only one to achieve selectivity up to high short-circuit current with selectivity category A circuit breaker according to IEC60947-2

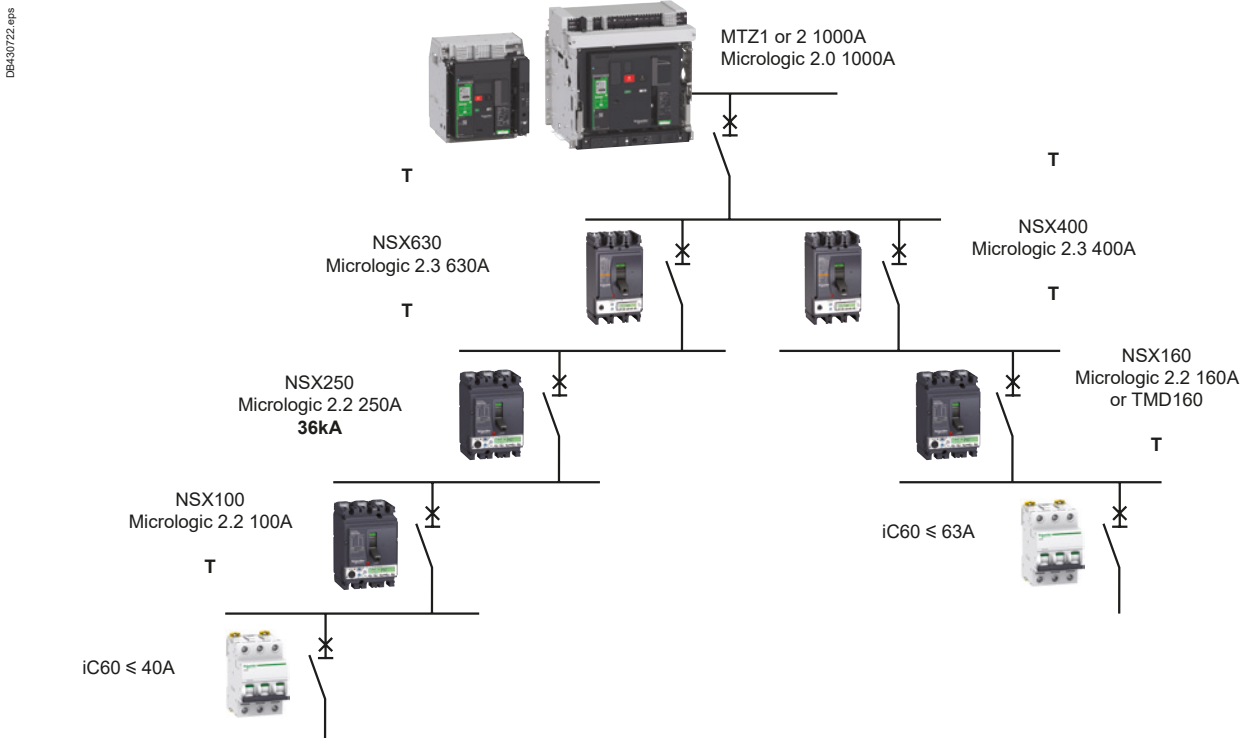

Practical example of selectivity at several levels with Schneider Electric circuit breakers (with electronic trip units)

# Coordination between circuit breakers

## Selectivity

A

### Selectivity enhanced by cascading

Cascading between 2 devices is normally achieved by using the tripping of the upstream circuit breaker A to help the downstream circuit breaker B to break the current.

By principle cascading is in contradiction with selectivity. But the energy selectivity technology implemented in Compact NSX circuit-breakers allows to improve the breaking capacity of downstream circuit-breakers and keep in the same time an high selectivity performance.

The principle is as follows:

- The downstream limiting circuit breaker B sees a very high short-circuit current. The tripping is very fast (<1 ms) and then, the current is limited
- The upstream circuit breaker A sees a limited short-circuit current compared to its breaking capability, but this current induces a repulsion of the contacts. As a result, the arcing voltage increases the current limitation. However, the arc energy is not high enough to induce the tripping of the circuit breaker. So, the circuit breaker A helps the circuit breaker B to trip, without tripping itself. The selectivity limit can be higher than Icu B and the selectivity becomes total with a reduced cost of the devices

### Logic selectivity or “Zone Sequence Interlocking – ZSI”

This type of selectivity can be achieved with circuit breakers equipped with specially designed electronic trip units (Compact, Masterpact): only the Short Time Protection (I<sub>sd</sub>, T<sub>sd</sub>) and Ground Fault Protection (GFP) functions of the controlled devices are managed by Logic Selectivity. In particular, the Instantaneous Protection function is not concerned.

One benefit of this solution is to have a short tripping time wherever is located the fault with selectivity category B circuit breaker. Time based selectivity on multi level system implies long tripping time at the origin of the installation.

### Settings of controlled circuit breakers

- time delay: staging of the time delays is necessary at least for circuit breaker receiving a ZSI Input (T<sub>sd</sub>D1 > trip time with no delay of D2 and T<sub>sd</sub>D2 > trip time with no delay of D3)

- thresholds: there are no threshold rules to be applied, but natural staging of the protection device ratings must be complied with (I<sub>sd</sub>D1 > I<sub>sd</sub>D2 > I<sub>sd</sub>D3).

**Note:** This technique ensures selectivity even with circuit breakers of similar ratings.

### Principles

Activation of the Logic Selectivity function is via transmission of information on the pilot wire:

- ZSI input:

- low level (no downstream faults): the Protection function is on standby with no time delay,
- high level (presence of downstream faults): the relevant Protection function moves to the time delay status set on the device.

- ZSI output:

- low level: the trip unit detects no faults and sends no orders,
- high level: the trip unit detects a fault and sends an order.

### Operation

A pilot wire connects in cascading form the protection devices of an installation (see Fig. H56). When a fault occurs, each circuit breaker upstream of the fault (detecting a fault) sends an order (high level output) and moves the upstream circuit breaker to its set time delay (high level input). The circuit breaker placed just above the fault does not receive any orders (low level input) and thus trips almost instantaneously.

Selectivity schemes based on logic techniques are possible, using CBs equipped with electronic tripping units designed for the purpose (Compact, Masterpact) and interconnected with pilot wires

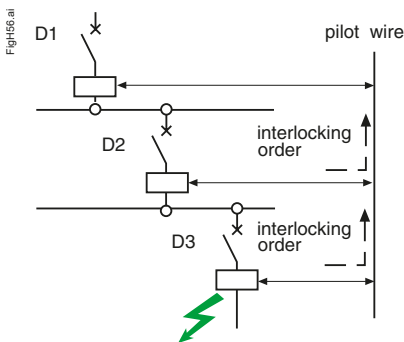

Logic selectivity



# Coordination between circuit breakers

## Selectivity



### Selectivity between modular circuit breakers

We use two types of selectivity when these circuit breakers are combined:

- current selectivity,
- energy selectivity.

For selectivity to be ensured whatever the prospective fault current, 3 conditions have to be fulfilled:

- the upstream and downstream circuit breakers must have different ratings (ratio > 1.3),
- their type of curve (B,C,D ...) shall be consistent to ensure D1 magnetic level > D2 magnetic level,
- the energy allowed to pass through the downstream circuit breaker when it cuts off must still be less than the operating energy of the upstream trip.

### Example

■ Let us take the example of a single phase network where we have a 32 A curve D circuit breaker in series with a 10 A curve D circuit breaker:

- the 32 A circuit breaker protects the 6<sup>2</sup> cables and the 10 A circuit breaker protects the 1.5<sup>2</sup> cables. This combination allows selectivity, but up to what threshold?
- if current selectivity is considered ( $t = f(I_p)$ ) it can be seen that the tripping curve of the downstream circuit breaker is well below the non-tripping curve of the upstream circuit breaker,
- furthermore, each circuit breaker is well below the maximum stress permitted by the cables.

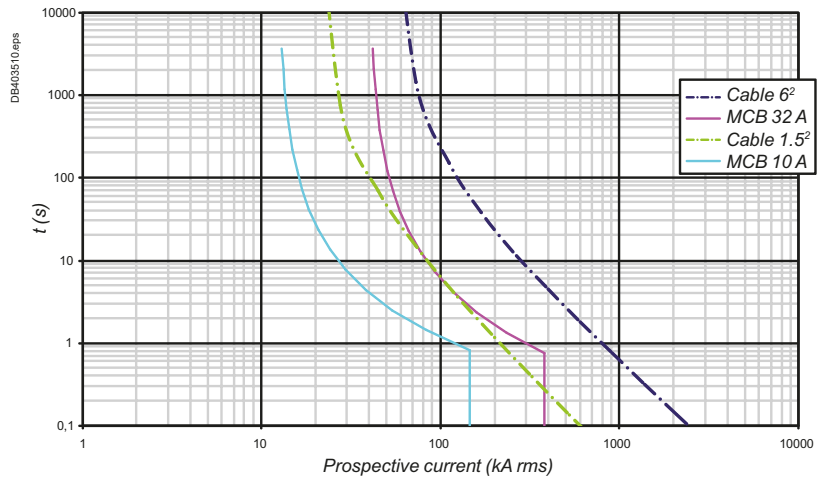
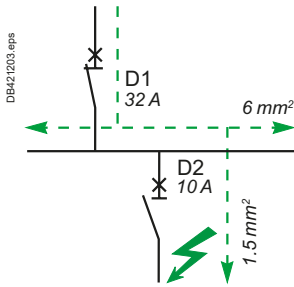

When considering energy selectivity, it is necessary to compare the maximum stresses characterized by the integrals  $I^2t$  relative to the development of the arc in the downstream device and by the sensitivity of the trip unit, still in  $I^2t$ , of the upstream device (curves  $I^2t = f(I_p)$ ).

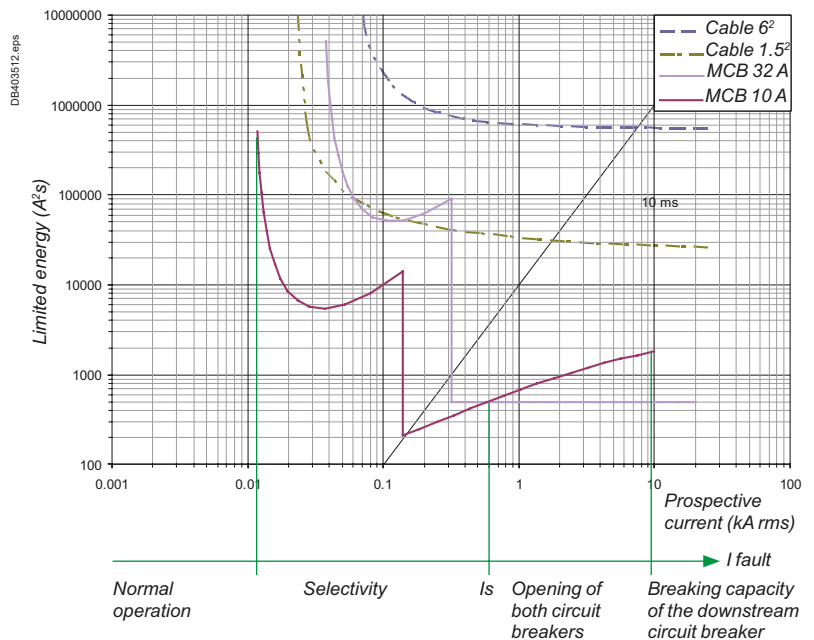

# Coordination between circuit breakers

## Selectivity

A

### Selectivity between Compact NSX upstream and modular circuit breakers downstream

Compact NSX circuit breakers have been designed to ensure total selectivity with Acti9 range.

- Total selectivity between Compact NSX 100 A with electronic trip unit and Acti9 circuit breaker up to 40 A.
- Total selectivity between Compact NSX  $\geq 160$  A with TMD trip unit  $\geq 125$  A or electronic trip unit and Acti9 up to 63 A.

### Selectivity between Compact NSX circuit breakers

Thanks to the Roto-Active breaking principle in the Compact NSX, a combination of Schneider Electric circuit breakers provides an exceptional level of selectivity between protection devices.

This performance is due to the combination and optimization of 3 principles:

- current selectivity,
- energy selectivity,
- time selectivity.

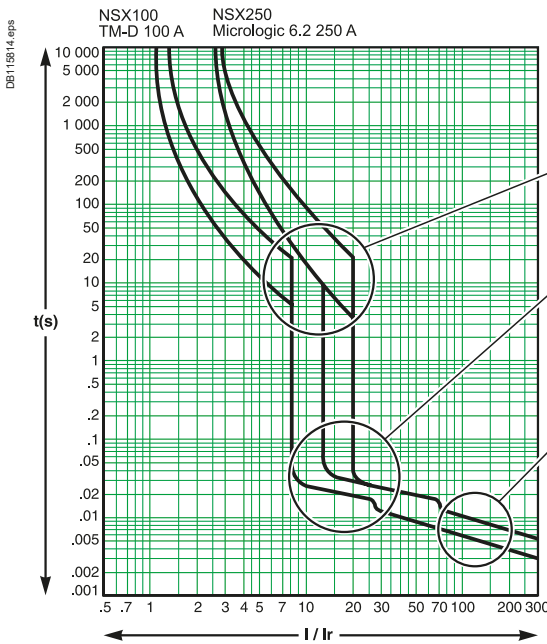

**Protection against overloads: current selectivity**

The protection is selective if the ratio between the setting thresholds is higher than 1.6 (in the case of two distribution circuit breakers).

**Protection against weak short circuits: time selectivity**

Tripping of the upstream device has a slight time delay; tripping of the downstream device is faster. The protection is selective if the ratio between the short-circuit protection thresholds is no less than 1.5.

**Protection against high short circuits: energy selectivity**

This principle combines the exceptional limiting power of the Compact NSX devices and reflex release, sensitive to the energy dissipated by the short circuit in the device. When a short circuit is high, if it is seen by two devices, the downstream device limits it greatly. The energy dissipated in the upstream device is insufficient to cause it to trip: there is selectivity whatever the value of the short circuit. The range has been designed to ensure energy selectivity between NSX630/NSX250/NSX100 or NSX400/NSX160.

### Selectivity between Masterpact or Compact NS $\geq 630$ A upstream and Compact NSX downstream

Thanks to their high-performance control units and a very innovative design, Masterpact and Compact NS  $\geq 630$  A devices offer, as standard, a very high level of selectivity with downstream Compact NSX up to 630 A

Respect the basic rules of selectivity for overload and short-circuit, or check that curves do not overlap with Ecodial software.

Check the selectivity limit in tables for high short-circuit current or when using limiter circuit breakers (Masterpact MTZ1 L1 or Compact NS L or LB) upstream.

### Selectivity between Masterpact or Compact NS $\geq 630$ A upstream and downstream

The utilization category of these devices (excepted limiters ones) is B according to IEC 60947 standard. Selectivity is ensured by a combination of current selectivity and time selectivity.

Respect the basic rules of selectivity for overload and short-circuit, or check that curves do not overlap with Ecodial software.

Check the selectivity limit in tables for high short-circuit current or when using limiter circuit breakers (Masterpact MTZ1 L1 or Compact NS L or LB).

# Coordination between circuit breakers

## Selectivity



### Basic rules of selectivity for overload and short-circuit

#### Requisite conditions

The values indicated in the tables (for 220, 380, 415 and 440 V) are guaranteed if the following conditions are respected:

Upstream (D1)	Downstream (D2)	Thermal protection I <sub>r</sub> up/I <sub>r</sub> down	Magnetic protection I <sub>m</sub> up/I <sub>m</sub> down
TM	TM or MCB	1.6	2
	Micrologic	1.6	1.5
	MA + Separate overload relay	3	2
	Thermal-magnetic motor circuit breaker	3	2
Micrologic	TM or MCB	1.6	1.5
	Micrologic	1.6	1.5
	MA + Separate overload relay	3	1.5
	Thermal-magnetic motor circuit breaker	3	1.5
TM-DC	TM TM-DC or MCB	3	2

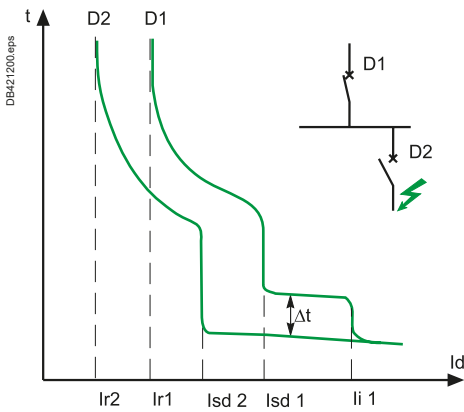

### Additional conditions for trip units with adjustable settings

#### Short time trip pickup current (I<sub>sd</sub>)

The tables in the following pages show the limit of selectivity assuming the short time trip pickup current "I<sub>sd</sub>" of upstream circuit-breaker is equal to 10 x I<sub>r</sub>.

- When the limit of selectivity indicated in the table is 10 x I<sub>r</sub>, the limit of selectivity is in fact the upstream magnetic threshold I<sub>sd</sub>.
- In many cases, when selectivity is total, a different adjustment of I<sub>sd</sub> (or I<sub>m</sub>) may be used provided that the ratio between the magnetic thresholds indicated above is observed and the additional following rules :

When downstream circuit-breaker is a Compact NSX with Micrologic 2.2 or 2.3:

- upstream circuit-breaker magnetic setting "I<sub>sd</sub>" (or I<sub>m</sub>) shall be higher than downstream fix instantaneous protection:

Downstream device trip unit	Micrologic 2.2				Micrologic 2.3	
Micrologic Rating	40A	100A	160A	250A	400A	630A
I <sub>sd</sub> (or I <sub>m</sub> ) minimum value for Compact NSX, Compact NS and Masterpact Micrologic upstream Compact NSX with Mic 2.x	600A	1500A	2400A	3000A	4800A	6900A

- or upstream circuit breaker shall be equipped with Micrologic type 5 with I<sub>sd<sub>up</sub></sub> ≥ 1.5 I<sub>sd<sub>down</sub></sub> and T<sub>sd</sub> ≥ 0.1

When downstream circuit breaker is a Compact NS or Masterpact with Micrologic 2.0, upstream circuit breaker shall be equipped with Micrologic type 5, 6 or 7.0 and: I<sub>sd<sub>up</sub></sub> ≥ 1.5 I<sub>sd<sub>down</sub></sub> and T<sub>sd</sub> ≥ 0.1.

#### Instantaneous trip pickup current (I<sub>i</sub>)

The selectivity tables show the limit of selectivity assuming the instantaneous trip pickup current set to its maximum value and when it is inhibited (category B circuit breaker only).

- When the limit of selectivity indicated in the table is 15 x I<sub>n</sub> of the upstream device, the limit of selectivity is in fact the instantaneous trip pickup current of the upstream device.
- When selectivity is total ("T"), a different adjustment of I<sub>i</sub> may be used provided that the ratio between the magnetic thresholds indicated above is observed and the additional following rules applied:

Downstream device trip unit:	Micrologic 2/4/5/6/7 .2				Micrologic 2/4/5/6/7.3	
Micrologic Rating	40A	100A	160A	250A	400A	630A
I <sub>i</sub> minimum value for Compact NSX, Compact NS and Masterpact Micrologic upstream Compact NSX	2000A	2250A	2500A	4000A	6300A	8000A

Masterpact MTZ with Micrologic X control unit offer two options for instantaneous trip: "Standard" and "fast". Selectivity tables are provided with "Standard" setting.

See Micrologic X User guide for setting guidelines.

# Coordination between circuit breakers

## Selectivity

A

### Short time tripping delay (Tsd)

When the upstream and downstream circuit breakers are fitted with a Micrologic 5.x, 6.x, 7.x: trip unit, the minimum non-tripping time of the upstream device must be greater than the maximum tripping time of the downstream device. This is ensured by staging Tsd :

### Tsd D1 > Tsd D2 (One band) & I2t Off

The tables show the limit of selectivity assuming function I2t OFF. If this is not the case, the user must verify that the curves do not overlap.

### Ground Fault Protection (GFP) (I<sub>g</sub>, T<sub>g</sub>)

When the upstream and downstream circuit breakers are fitted with a Micrologic 6.x trip unit, the user must verify current and time selectivity:

- The setting of the tripping threshold of the upstream GFP is greater than that of the downstream GFP.
- The intentional time-delay setting for the upstream GFP is higher than the opening time of the downstream protection device. Furthermore, it is essential that the intentional time-delay applied to the upstream protection device observes the maximum insulation fault elimination time defined by NEC § 230.95 (i.e. 1 s for 3000 A).

$I_g D1 \geq 1,3 I_g D2$  &  $T_g D1 > T_g D2$  (One band).

# Coordination between circuit breakers

## Selectivity



Example of circuit-breaker with add-on module iC40 + Vigi.



Example of separate earth leakage relay RHU.

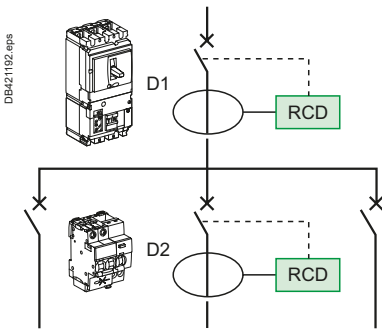

### Selectivity of RCDs

When circuit breakers are equipped with RCD function, selectivity tables are valid for short-circuit and earth fault with high amplitude current.

Residual Current Devices are by design very sensitive to fault and shall be coordinated properly to achieve total selectivity in addition to overcurrent protection.

Schneider Electric propose a wide range of solution to ensure RCD function:

- Circuit breaker Add-On Residual Current Device (Vigi module)
- Circuit breaker with integrated RCD function
- Residual Current circuit breaker (RCBO) like iCV40,
- Earth Leakage circuit breaker (ELCB) like Compact NSXm with Micrologic 4.1, Compact NSX Micrologic 4.x or 7.x, Masterpact and Compact with Micrologic 7.0\* ,
- Circuit breaker with separate earth leakage relay (any circuit breaker with separated Vigirex RH● range)
- Residual current circuit breaker (no overcurrent) like iID range.

All these devices from Schneider Electric are following by design the same rules for sensitivity and tripping time even if they are covered by different standard (IEC/EN 61009-1, IEC/EN 60947-2 Annex B or Annex M, IEC 61008). So whatever the type of RCD is, the following rules apply:

- the sensitivity of the upstream residual current device must be at least equal to three times the sensitivity of the downstream residual current device
- the upstream residual current device must be:
  - of the selective (S) type (or setting) if the downstream residual current device is an instantaneous type,
  - of the delayed (R) type (or setting) if the downstream residual current device is a selective type. The minimum non-tripping time of the upstream device will therefore be greater than the maximum tripping time of the downstream device for all current values.

$$I\Delta n D1 \geq 3 \times I\Delta n D2 \text{ \& \Delta t (D1) > \Delta t (D2).}$$

Range	Device	Standard IEC/EN			Type	Operating range	
		61008	61009-1 61009-2-1	60947-2		Sensitivity	Operating Time
Acti 9 iID	iID RCCB	■			AC/A/SI/B	Fix	Inst / S
Acti 9 iC60	iC60 RCBO		■		AC/A/SI	Fix	Inst / S
Acti 9 iDPN/iC40	iDPN Vigi / iCV40		■		AC/A/SI	Fix	Inst / S
Acti 9 iDPN/iC40	iDPN /iC40 Vigi add on		■		AC/A/SI	Fix	Inst / S
Acti 9 iC60	iC60 Vigi add on		■		AC/A/SI	Fix	Inst / S
Acti 9 C120	C120 Vigi add on		■		AC/A/SI	Fix	Inst / S
Multi9 NG125	NG125 Vigi add on		■	■ (An. B)	AC/A/SI	Fix / Adj	Inst / S / R
Compact NSX	NSXm160 Mic. 4.1			■ (An. B)	A	Adj 30mA-1A	Adjustable
	NSX100-250 Vigi add on			■ (An. B)	A	Fix or adj 30mA-10A	Fix or adjustable
	NSX100-250 Mic 4.2/7.2			■ (An. B)	A	Adj 30mA-10A	Adjustable
	NSX400-630 Vigi add on			■ (An. B)	A	Adj 300mA-30A	Adjustable
	NSX400-630 Mic 4.3/7.3			■ (An. B)	A	Adj 300mA-30A	Adjustable
Compact	NS630-1600 Micrologic 7.0*			■ (An. B)	A	Adj 500mA-30A	Adjustable
Masterpact	MTZ1/2 Micrologic 7.0X			■ (An. B)	A	Adj 500mA-30A	Adjustable
Vigirex	Vigirex RH + toroid			■ (An. M)	A	Fix or adj 30mA-30A	Fix or adjustable

IEC61008 and IEC61009-1 +IEC 61009-2-1 devices are designed for household and similar uses.

IEC60947-2 Annex B or M device shall be installed only in part of the installation accessible only to instructed persons (BA4) or skilled 134 persons (BA5).

# Coordination between circuit breakers

## Selectivity

A



Example of circuit-breakers with integrated earth leakage protection : Compact NSX with Micrologic 7.2A, iCV40.

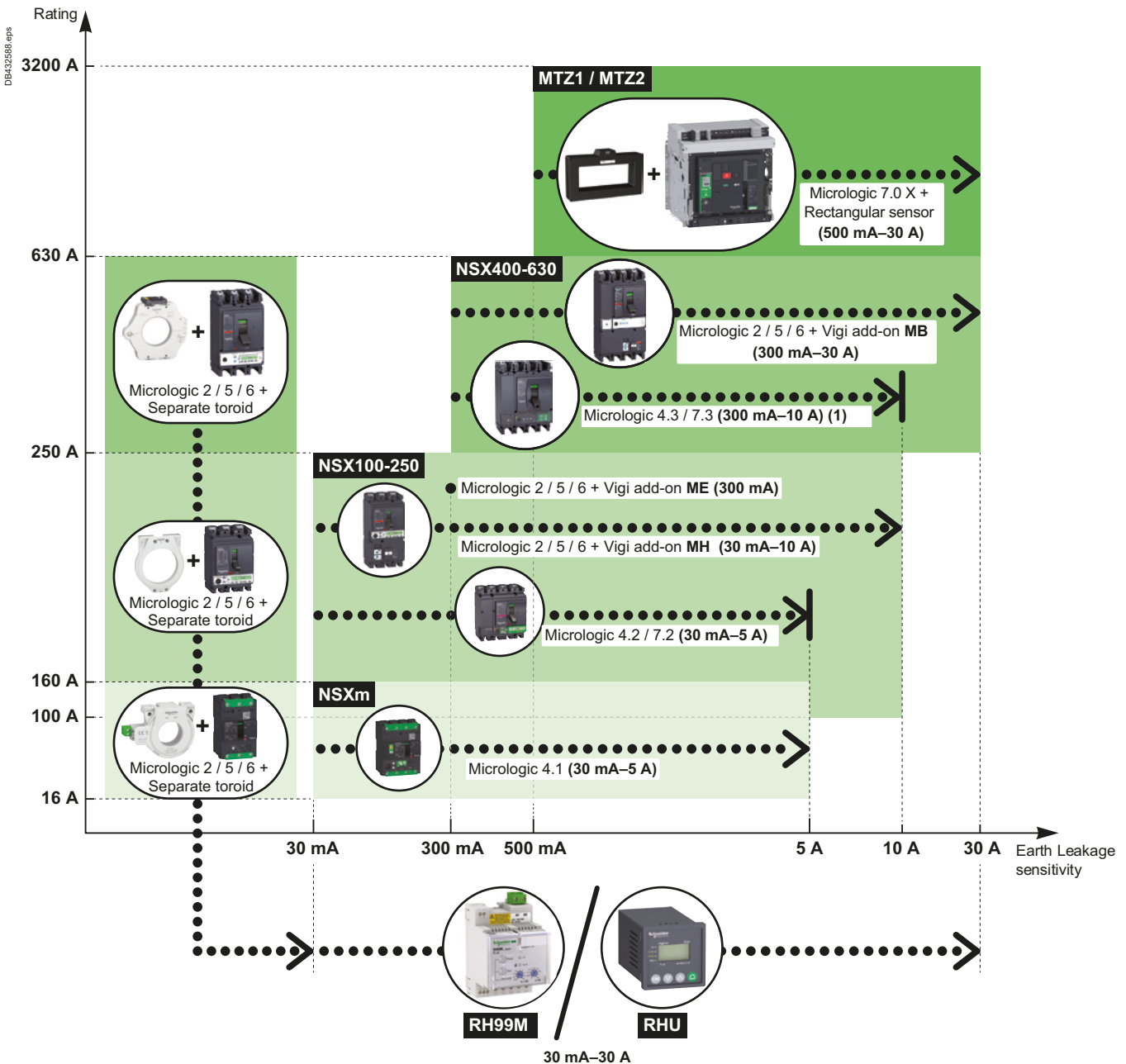

(1) Residual Current Monitoring version also available for Micrologic 4.2 7.2 4.3 7.3 ("AL" version).

# Coordination between circuit breakers

## Selectivity



For more detail on RCD and selectivity of RCD see Electrical installation guide Chapter F or [www.electrical-installation.org](http://www.electrical-installation.org).

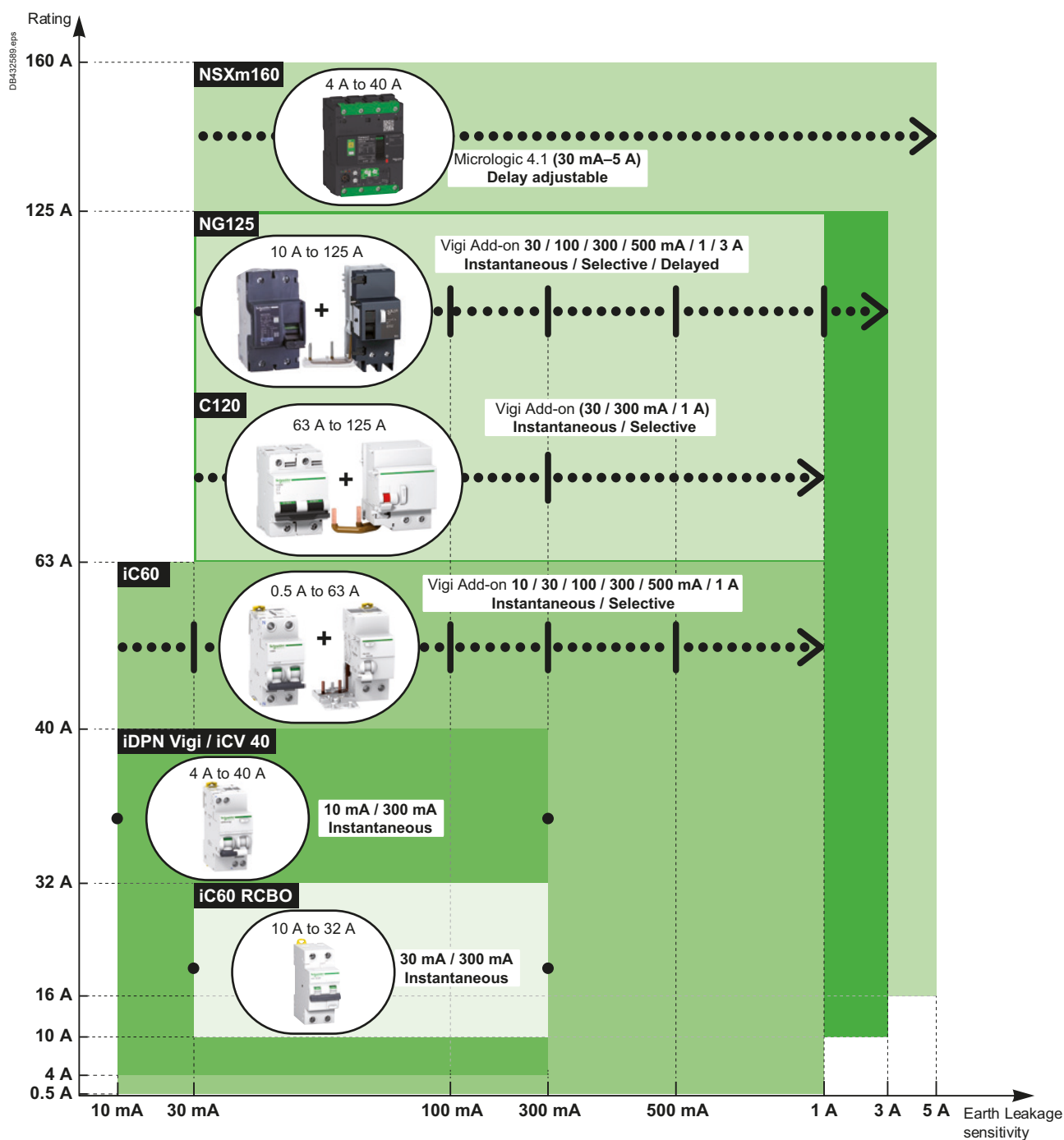

# Coordination between circuit breakers

## Selectivity of modular circuit breakers

A

### Using the selectivity tables

Depending on the network and the type of downstream circuit breaker, the selection table below indicates which table should be consulted to find out the selectivity value.

The selectivity values are given in colour-coded tables.

■ For 220-240 V/380-415 V 50/60 Hz systems:

□ in the case of a 2P downstream circuit breaker in a single-phase network (220-240 V), refer to the light green tables,

□ in the case of 1P, 1P+N, 3P, 3P+N, 4P and 2P circuit breakers in a two-phase network (380-415 V), refer to the dark green tables.

### Selection table

		Upstream network		
		 DBI23996.eps	 DBI23998.eps	 DBI23997.eps
Type of Downstream network	Type of Downstream protection device	Ph/N 220-240 V	Ph/N 220-240 V Ph/Ph 380-415 V	Ph/Ph 380-415 V
 DBI24079.eps	 DBI23981.eps 2P			
	 DBI124151.eps 1P			
	 DBI23992.eps 1P+N			
 DBI24192.eps	 DBI23991.eps 2P			
 DBI24080.eps	 DBI23993.eps 3P			
 DBI24081.eps	 DBI23994.eps 4P			
	 DBI23993.eps 3P+N			

**Note:** this selection table shows you the colour.

By taking your downstream protection device, the type of upstream network and its voltage you can refer to the corresponding selectivity table.



# Coordination between circuit breakers

## Selectivity of modular circuit breakers

### Example: solution diagram

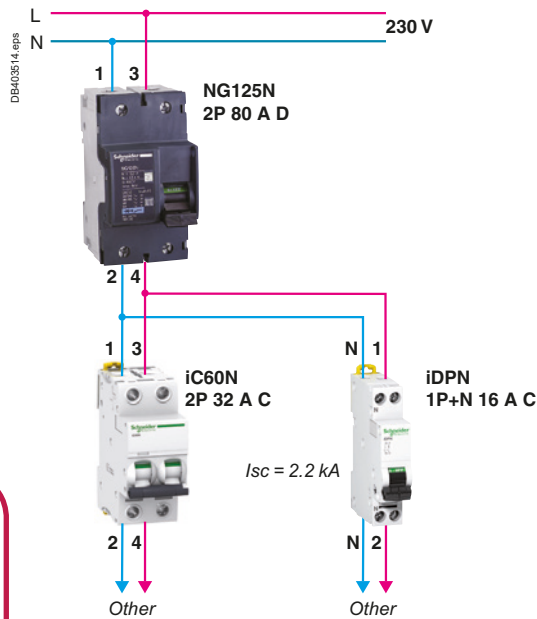

Upstream we have a NG125N 80 A 2P curve D and downstream an iC60N 32 A 2P curve C. The network is 230 V between phase and neutral. By referring to the light green table on the selectivity page for NG125N curve D with iC60 downstream, we find 2200 A.

If the downstream product is replaced by an iDPN 1P+N curve C, you will use the dark green table for NG125N curve D and iDPN 1P+N downstream. The selectivity level is 2400 A for a 16 A.

### Specifications

We want to achieve continuity of service in the event of a fault downstream of the NG125N 80 A. This circuit has an  $I_{sc}$  of 2.2 kA under a voltage of 230 V. By referring to the table for 230 V, 1P+N network, we find that for an upstream NG125N curve D with a rating of 80 A, we can have total selectivity up to 16 A if we use an iC60N 1P+N and up to 32 A with an iC60N 2P.

Upstream		NG125N/H/L										
		Curve D										
In (A)		10	16	20	25	32	40	50	63	80	100	125
Downstream	2P (220-240 V) single-phase network											
Selectivity limit (A)												
iC60N/H/L	0.5	T	T	T	T	T	T	T	T	T	T	T
Curve C	1	T	T	T	T	T	T	T	T	T	T	T
	2	1200	T	T	T	T	T	T	T	T	T	T
	3	21	3400	3400	T	T	T	T	T	T	T	T
	4	18	1200	1300	5800	5600	T	T	T	T	T	T
	6	15	700	720	1900	1900	6000	11000	T	T	T	T
	10		22	480	1200	1200	2200	4200	10000	T	T	T
	13			28	51	900	1800	3000	7300	8000	T	T
	16				35	740	1300	2200	4700	5400	T	T
	20					46	88	1700	3500	3500	6900	T
	25						56	600	2500	2500	4600	6800
	32							80	2000	2200	3400	4400
	40								756	1900	2900	3500
	50									960	2300	2800
	63										2300	2800

4000 Selectivity limit = 4 kA.

T Total selectivity.

No selectivity.

$I_s > I_{sc}$  Total selectivity

# Coordination between circuit breakers

## Selectivity of modular circuit breakers

A

### Contents

Downstream		Upstream											
Type		iDPN, iDPN N			iC40, iC40N			iC60N/H/L			NG125N/H/L, C120N/H		
	Curve	B	C	D	B	C	D	B	C	D	B	C	D
iDPN	B	page A-15	page A-16	page A-17	-	-	-	page A-24	page A-25	page A-26	page A-45	page A-46	page A-47
iDPN N	C	page A-15	page A-16	page A-17	-	-	-	page A-24	page A-25	page A-26	page A-45	page A-46	page A-47
	D	page A-15	page A-16	page A-17	-	-	-	page A-24	page A-25	page A-26	page A-45	page A-46	page A-47
iDPN N vigi	B	page A-15	page A-16	page A-17	-	-	-	page A-24	page A-25	page A-26	page A-45	page A-46	page A-47
iDPN H vigi	C	page A-15	page A-16	page A-17	-	-	-	page A-24	page A-25	page A-26	page A-45	page A-46	page A-47
iC40	B	-	-	-	page A-18	page A-19	page A-20	page A-27	page A-28	page A-29	page A-48	page A-49	page A-50
iC40N	C	-	-	-	page A-18	page A-19	page A-20	page A-27	page A-28	page A-29	page A-48	page A-49	page A-50
	D	-	-	-	page A-18	page A-19	page A-20	page A-27	page A-28	page A-29	page A-48	page A-49	page A-50
iCV40N	B	-	-	-	page A-21	page A-22	page A-23	page A-30	page A-31	page A-32	page A-48	page A-49	page A-50
	C	-	-	-	page A-21	page A-22	page A-23	page A-30	page A-31	page A-32	page A-48	page A-49	page A-50
iC60N/H/L	B	-	-	-	-	-	-	page A-33	page A-35	page A-37	page A-51	page A-53	page A-55
	C	-	-	-	-	-	-	page A-33	page A-35	page A-37	page A-51	page A-53	page A-55
	D	-	-	-	-	-	-	page A-33	page A-35	page A-37	page A-51	page A-53	page A-55
iC60 RCBO	B	-	-	-	-	-	-	page A-39	page A-41	page A-43	page A-57	page A-59	page A-61
	C	-	-	-	-	-	-	page A-39	page A-41	page A-43	page A-57	page A-59	page A-61
	D	-	-	-	-	-	-	page A-40	page A-42	page A-44	page A-58	page A-60	page A-62
C120, NG125	B	-	-	-	-	-	-	-	-	-	page A-63	page A-65	page A-67
	C	-	-	-	-	-	-	-	-	-	page A-63	page A-65	page A-67
	D	-	-	-	-	-	-	-	-	-	page A-63	page A-65	page A-67

### Selectivity between circuit breakers

In the following tables we show the level of selectivity between two LV circuits that are protected by circuit breakers.

This selectivity will be either:

- total: represented by a T (up to the breaking capacity of the downstream device),
- partial: selectivity limit current (Is) indicated. Below this value selectivity is ensured, above this value the upstream device is also involved in breaking,
- : no selectivity ensured.

# Selectivity table

Upstream: iDPN, iDPN N curve B

Downstream: iDPN/iDPN N curves B, C, D, iDPN N Vigi / iDPN H vigi curves B, C

220-240/380-415 V AC



Upstream		iDPN, iDPN N										
		Curve B										
In (A)		1	2	3	4	6	10	16	20	25	32	40
<b>Downstream</b>												
<b>1P+N</b>												
<b>3P, 3P+N</b>												
<b>Selectivity limit (A)</b>												
iDPN	1		8	12	20	30	70	150	250	350	610	980
iDPN N	2			12	16	30	60	110	180	240	340	450
iDPN N vigi	3					30	40	64	140	190	280	350
iDPN H vigi	4					10	40	64	120	160	220	280
Curve B	6						40	64	80	100	130	160
	10							64	80	100	130	160
	16									100	130	160
	20										130	160
	25											160
<b>Selectivity limit (A)</b>												
iDPN	1		6	12	20	30	70	150	250	350	610	980
iDPN N	2				12	30	60	110	180	240	340	450
iDPN N vigi	3					13	40	64	140	190	280	350
iDPN H vigi	4						32	64	120	160	220	280
Curve C	6							51	80	100	130	160
	10								64	80	130	160
	16										102	128
	20											128
<b>Selectivity limit (A)</b>												
iDPN	1				12	30	70	150	250	350	610	980
iDPN N	2					19	60	110	180	240	340	450
Curve D	3						32	64	140	190	280	350
	4							51	120	160	220	280
	6								64	80	130	160
	10										102	128
	16											128

4000 Selectivity limit = 4 kA.

No selectivity.

Note: if you cannot find your combination, refer to the selection table on page A-12

# Selectivity table

Upstream: iDPN, iDPN N curve C

Downstream: iDPN/iDPN N curves B, C, D, iDPN N Vigi / iDPN H vigi curves B, C



## 220-240/380-415 V AC

Upstream	iDPN, iDPN N										
	Curve C										
In (A)	1	2	3	4	6	10	16	20	25	32	40

Downstream	1P+N											
	3P, 3P+N											

Selectivity limit (A)												
iDPN	1		16	24	32	70	180	400	630	1200	T	T
iDPN N	2			24	32	48	140	270	350	510	820	830
iDPN N vigi	3				32	48	80	210	290	380	630	650
iDPN H vigi	4					48	80	130	240	320	480	510
Curve B	6						80	130	160	200	320	380
	10							130	160	200	260	320
	16								160	200	260	320
	20										260	320
	25											320

Selectivity limit (A)												
iDPN	1		16	24	32	70	180	400	630	1200	T	T
iDPN N	2			24	32	48	140	270	350	510	820	830
iDPN N vigi	3				9	48	80	210	290	380	630	650
iDPN H vigi	4					10	80	130	240	320	480	510
Curve C	6						80	130	160	200	320	380
	10							130	160	200	260	320
	16								45	200	260	320
	20										260	320
	25											320

Selectivity limit (A)												
iDPN	1		16	24	32	70	180	400	630	1200	T	T
iDPN N	2				25	48	140	270	350	510	820	830
Curve D	3					13	80	210	290	380	630	650
	4						80	130	240	320	480	510
	6							128	160	200	320	380
	10								128	200	260	320
	16									141	153	320
	20											256

4000 Selectivity limit = 4 kA.

T Total selectivity.

No selectivity.

Note: if you cannot find your combination, refer to the selection table on page A-12

# Selectivity table

Upstream: iDPN, iDPN N curve D

Downstream: iDPN/iDPN N curves B, C, D, iDPN N Vigi / iDPN H vigi curves B, C

220-240/380-415 V AC



Upstream	iDPN, iDPN N										
	Curve D										
In (A)	1	2	3	4	6	10	16	20	25	32	40

Downstream	1P+N	3P, 3P+N
------------	------	----------

Selectivity limit (A)												
iDPN	1		24	36	70	170	380	1200	T	T	T	T
iDPN N	2			36	48	130	250	490	780	1100	1600	2300
iDPN N vigi	3				48	72	210	410	640	890	1400	1900
iDPN H vigi	4					72	120	330	500	670	970	1400
Curve B	6						120	190	390	520	740	1000
	10							190	240	300	580	810
	16									300	380	480
	20										380	480
	25											480
	32											480
Selectivity limit (A)												
iDPN	1		24	36	70	170	380	1200	T	T	T	T
iDPN N	2			36	48	130	250	490	780	1100	1600	2300
iDPN N vigi	3				9	72	210	410	640	890	1400	1900
iDPN H vigi	4					10	120	330	500	670	970	1400
Curve C	6							190	390	520	740	1000
	10							190	240	300	580	810
	16									300	380	480
	20										380	480
	25											480
Selectivity limit (A)												
iDPN	1		24	36	70	170	380	1200	T	T	T	T
iDPN N	2			36	48	130	250	490	780	1100	1600	2300
Curve D	3					14	210	410	640	890	1400	1900
	4					10	120	330	500	670	970	1400
	6						120	190	390	520	740	1000
	10							190	240	300	580	810
	16									300	380	480
	20										380	480
	25											480

4000 Selectivity limit = 4 kA.

T Total selectivity.

No selectivity.

Note: if you cannot find your combination, refer to the selection table on page A-12

# Selectivity table

Upstream: iC40, iC40 N curve B

Downstream: iC40, iC40 N curves B, C, D

A

## 220-240/380-415 V AC

Upstream		iC40, iC40 N											
		Curve B											
In (A)		1	2	3	4	6	10	16	20	25	32	40	
<b>Downstream</b>													
<b>1P+N</b>													
<b>3P, 3P+N</b>													
<b>Selectivity limit (A)</b>													
iC40	2				12	16	30	60	110	180	240	340	450
iC40 N	4						10	40	64	120	160	220	280
Curve B	6							40	64	80	100	130	160
	10								64	80	100	130	160
	13										100	130	160
	16										100	130	160
	20											130	160
	25												160
<b>Selectivity limit (A)</b>													
iC40	2				12	30	60	110	180	240	340	450	
iC40 N	4						32	64	120	160	220	280	
Curve C	6							51	80	100	130	160	
	10								64	80	130	160	
	13										102	128	
	16										102	128	
	20											128	
<b>Selectivity limit (A)</b>													
iC40	2					19	60	110	180	240	340	450	
iC40 N	4							51	120	160	220	280	
Curve D	6								64	80	130	160	
	10										102	128	
	13											128	
	16											128	

4000 Selectivity limit = 4 kA.

No selectivity.

Note: if you cannot find your combination, refer to the selection table on page A-12

# Selectivity table

Upstream: iC40, iC40 N curve C

Downstream: iC40, iC40 N curves B, C, D

## 220-240/380-415 V AC



Upstream		iC40, iC40 N										
		Curve C										
In (A)		1	2	3	4	6	10	16	20	25	32	40
<b>Downstream 1P+N</b>												
<b>3P, 3P+N</b>												
<b>Selectivity limit (A)</b>												
Curve B	2			24	32	48	140	270	350	510	820	830
	4					48	80	130	240	320	480	510
	6						80	130	160	200	320	380
	10							130	160	200	260	320
	13								160	200	260	320
	16								160	200	260	320
	20										260	320
	25											320
<b>Selectivity limit (A)</b>												
Curve C	2			24	32	48	140	270	350	510	820	830
	4					10	80	130	240	320	480	510
	6						80	130	160	200	320	380
	10							130	160	200	260	320
	13								45	200	260	320
	16								45	200	260	320
	20										260	320
	25											320
<b>Selectivity limit (A)</b>												
Curve D	2				25	48	140	270	350	510	820	830
	4						80	130	240	320	480	510
	6							128	160	200	320	380
	10								128	200	260	320
	13									141	153	320
	16									141	153	320
	20											256

4000 Selectivity limit = 4 kA.

No selectivity.

**Note:** if you cannot find your combination, refer to the selection table on page A-12

# Selectivity table

Upstream: iC40, iC40 N curve D

Downstream: iC40, iC40 N curves B, C, D

A

## 220-240/380-415 V AC

Upstream		iC40, iC40 N										
		Curve D										
In (A)		1	2	3	4	6	10	16	20	25	32	40
<b>Downstream 1P+N</b>												
<b>3P, 3P+N</b>												
<b>Selectivity limit (A)</b>												
iC40	2			36	48	130	250	490	780	1100	1600	2300
iC40 N	4					72	120	330	500	670	970	1400
Curve B	6						120	190	390	520	740	1000
	10							190	240	300	580	810
	13									300	380	480
	16									300	380	480
	20										380	480
	25											480
	32											480
<b>Selectivity limit (A)</b>												
iC40	2			36	48	130	250	490	780	1100	1600	2300
iC40 N	4					10	120	330	500	670	970	1400
Curve C	6							190	390	520	740	1000
	10							190	240	300	580	810
	13									300	380	480
	16									300	380	480
	20										380	480
	25											480
<b>Selectivity limit (A)</b>												
iC40	2			36	48	130	250	490	780	1100	1600	2300
iC40 N	4					10	120	330	500	670	970	1400
Curve D	6						120	190	390	520	740	1000
	10							190	240	300	580	810
	13									300	380	480
	16									300	380	480
	20										380	480
	25											480

4000 Selectivity limit = 4 kA.

No selectivity.

Note: if you cannot find your combination, refer to the selection table on page A-12



# Selectivity table

Upstream: iC40, iC40 N curve B

Downstream: iCV40 N, iCV40 H curves B, C

## 220-240/380-415 V AC



Upstream		iC40, iC40 N										
		Curve B										
In (A)		1	2	3	4	6	10	16	20	25	32	40

Downstream		1P+N										
		3P, 3P+N										

**Selectivity limit (A)**

iCV40 N	2			12	16	30	60	110	180	240	340	450
iCV40 H	4					10	40	64	120	160	220	280
Curve B	6						40	64	80	100	130	160
	10							64	80	100	130	160
	13									100	130	160
	16									100	130	160
	20										130	160
	25											160

**Selectivity limit (A)**

iCV40 N	2				12	30	60	110	180	240	340	450
iCV40 H	4						32	64	120	160	220	280
Curve C	6							51	80	100	130	160
	10								64	80	130	160
	13										102	128
	16										102	128
	20											128

4000 Selectivity limit = 4 kA.

No selectivity.

**Note:** if you cannot find your combination, refer to the selection table on page A-12

# Selectivity table

Upstream: iC40, iC40 N curve C

Downstream: iCV40 N, iCV40 H curves B, C

A

## 220-240/380-415 V AC

Upstream	iC40, iC40 N Curve C										
In (A)	1	2	3	4	6	10	16	20	25	32	40

Downstream	1P+N 3P, 3P+N											
------------	------------------	--	--	--	--	--	--	--	--	--	--	--

Selectivity limit (A)												
iCV40 N	2			24	32	48	140	270	350	510	820	830
iCV40 H	4					48	80	130	240	320	480	510
Curve B	6						80	130	160	200	320	380
	10							130	160	200	260	320
	13								160	200	260	320
	16								160	200	260	320
	20										260	320
	25											320
Selectivity limit (A)												
iCV40 N	2			24	32	48	140	270	350	510	820	830
iCV40 H	4					10	80	130	240	320	480	510
Curve C	6						80	130	160	200	320	380
	10							130	160	200	260	320
	13								45	200	260	320
	16								45	200	260	320
	20										260	320
	25											320

4000 Selectivity limit = 4 kA.

No selectivity.

Note: if you cannot find your combination, refer to the selection table on page A-12

# Selectivity table

Upstream: iC40, iC40 N curve D

Downstream: iCV40 N, iCV40 H curves B, C

## 220-240/380-415 V AC



Upstream		iC40, iC40 N Curve D										
In (A)		1	2	3	4	6	10	16	20	25	32	40

Downstream		1P+N 3P, 3P+N										
Selectivity limit (A)												
iCV40 N	2			36	48	130	250	490	780	1100	1600	2300
iCV40 H	4					72	120	330	500	670	970	1400
Curve B	6						120	190	390	520	740	1000
	10							190	240	300	580	810
	13									300	380	480
	16									300	380	480
	20										380	480
	25											480
	32											480
Selectivity limit (A)												
iCV40 N	2			36	48	130	250	490	780	1100	1600	2300
iCV40 H	4					10	120	330	500	670	970	1400
Curve C	6							190	390	520	740	1000
	10							190	240	300	580	810
	13									300	380	480
	16									300	380	480
	20										380	480
	25											480

4000 Selectivity limit = 4 kA.

No selectivity.

**Note:** if you cannot find your combination, refer to the selection table on page A-12

# Selectivity table

Upstream: iC60N/H/L curve B

Downstream: iDPN/iDPN N curves B, C, D, iDPN N Vigi / iDPN H vigi curves B, C

A

## 220-240/380-415 V AC

Upstream		iC60N/H/L												
		Curve B												
In (A)		2	3	4	6	10	13	16	20	25	32	40	50	63
<b>Downstream</b>														
<b>1P+N</b>														
<b>3P, 3P+N</b>														
<b>Selectivity limit (A)</b>														
iDPN	1	8	12	16	30	60	80	110	130	150	270	410	450	620
iDPN N	2		12	16	24	40	50	90	80	100	220	300	330	440
iDPN N Vigi	3				24	40	50	64	80	100	210	270	300	410
iDPN H Vigi	4				14	40	50	64	80	100	190	270	300	380
Curve B	6					40	50	64	80	100	130	240	250	250
	10							64	80	100	130	160	200	250
	16									100	130	160	200	250
	20										130	160	200	250
	25											160	200	250
	32												200	250
	40													250
<b>Selectivity limit (A)</b>														
iDPN	1		12	16	30	60	80	110	130	150	270	410	450	620
iDPN N	2			5	24	40	50	90	80	100	220	300	330	440
iDPN N Vigi	3				17	40	50	64	80	100	210	270	300	410
iDPN H Vigi	4					34	50	64	80	100	190	270	300	380
Curve C	6							47	80	100	130	240	250	250
	10								64	80	130	160	200	250
	16										102	128	200	250
	20											128	160	250
	25												160	201
	32													201
<b>Selectivity limit (A)</b>														
iDPN	1			12	30	60	80	110	130	150	270	410	450	620
iDPN N	2				19	40	50	90	80	100	220	300	330	440
Curve D	3					32	50	64	80	100	210	270	300	410
	4							51	80	100	190	270	300	380
	6								59	78	130	240	250	250
	10										102	128	200	250
	16											128	160	201
	20												160	201
	25													201

4000 Selectivity limit = 4 kA.

No selectivity.

Note: if you cannot find your combination, refer to the selection table on page A-12

# Selectivity table

Upstream: iC60N/H/L curve C

Downstream: iDPN/iDPN N curves B, C, D, iDPN N Vigi / iDPN H vigi curves B, C

220-240/380-415 V AC



Upstream	iC60N/H/L													
	Curve C													
In (A)	1	2	3	4	6	10	13	16	20	25	32	40	50	63

Downstream	1P+N	3P, 3P+N
------------	------	----------

Selectivity limit (A)

iDPN	1		16	24	32	48	80	100	210	270	390	540	790	1500	1600
iDPN N	2			24	32	48	80	100	130	160	300	410	540	910	930
iDPN N Vigi	3				5	48	80	100	130	160	200	260	510	750	760
iDPN H Vigi	4					48	80	100	130	160	200	260	480	720	760
Curve B	6						80	100	130	160	200	260	320	400	500
	10							100	130	160	200	260	320	400	500
	16										200	260	320	400	500
	20											260	320	400	500
	25												320	400	500
	32													400	500
	40														500

Selectivity limit (A)

iDPN	1		16	24	32	48	80	100	210	270	390	540	790	1500	1600
iDPN N	2			24	32	48	80	100	130	160	300	410	540	910	930
iDPN N Vigi	3					48	80	100	130	160	200	260	510	750	760
iDPN H Vigi	4					14	80	100	130	160	200	260	480	720	760
Curve C	6						80	100	130	160	200	260	320	400	500
	10								130	160	200	260	320	400	500
	16										83	260	320	400	500
	20											260	320	400	500
	25												124	400	500
	32													163	500
	40														186

Selectivity limit (A)

iDPN	1		16	24	32	48	80	100	210	270	390	540	790	1500	1600	
iDPN N	2				25	48	80	100	130	160	300	410	540	910	930	
Curve D	3						80	100	130	160	200	260	510	750	760	
	4						80	100	130	160	200	260	480	720	760	
	6							100	130	160	200	260	320	400	500	
	10										200	260	320	400	500	
	16											83	165	320	400	500
	20													151	400	500
	25														176	500
	32															255

4000 Selectivity limit = 4 kA.

No selectivity.

Note: if you cannot find your combination, refer to the selection table on page A-12

# Selectivity table

Upstream: iC60N/H/L curve D

Downstream: iDPN/iDPN N curves B, C, D, iDPN N Vigi / iDPN H vigi curves B, C

## 220-240/380-415 V AC

A

Upstream		iC60N/H/L													
		Curve D													
In (A)		1	2	3	4	6	10	13	16	20	25	32	40	50	63
<b>Downstream 1P+N</b>															
<b>3P, 3P+N</b>															
<b>Selectivity limit (A)</b>															
iDPN	1		30	50	70	72	120	260	350	540	700	1100	1500	2000	2000
iDPN N	2			36	48	72	120	160	190	390	510	700	960	1500	2000
iDPN N Vigi	3				5	72	120	160	190	360	450	580	840	1200	1500
iDPN H Vigi	4					72	120	160	190	240	450	580	780	1100	1400
Curve B	6						120	160	190	240	300	380	720	1000	1200
	10							160	190	240	300	380	480	600	760
	16										300	380	480	600	760
	20											380	480	600	760
	25												480	600	760
	32													600	760
	40														760
<b>Selectivity limit (A)</b>															
iDPN	1		30	50	70	72	120	260	350	540	700	1100	1500	2000	2000
iDPN N	2			36	48	72	120	160	190	390	510	700	960	1500	2000
iDPN N Vigi	3				5	72	120	160	190	360	450	580	840	1200	1500
iDPN H Vigi	4					14	120	160	190	240	450	580	780	1100	1400
Curve C	6						120	160	190	240	300	380	720	1000	1200
	10							34	190	240	300	380	480	600	760
	16										300	380	480	600	760
	20											380	480	600	760
	25												124	600	760
	32													163	760
	40														186
<b>Selectivity limit (A)</b>															
iDPN	1		30	50	70	72	120	260	350	540	700	1100	1500	2000	2000
iDPN N	2			36	48	72	120	160	190	390	510	700	960	1500	2000
Curve D	3					17	120	160	190	360	450	580	840	1200	1500
	4					14	120	160	190	240	450	580	780	1100	1400
	6						120	160	190	240	300	380	720	1000	1200
	10								57	240	300	380	480	600	760
	16											83	380	480	600
	20												155	151	600
	25													124	180
	32														163
	40														

4000 Selectivity limit = 4 kA.

No selectivity.

Note: if you cannot find your combination, refer to the selection table on page A-12

# Selectivity table

Upstream: iC60N/H/L curve B

Downstream: iC40, iC40 N curves B, C, D

## 220-240/380-415 V AC



Upstream		iC60N/H/L										
		Curve B										
In (A)		1	2	3	4	6	10	16	20	25	32	40
<b>Downstream</b>												
<b>1P+N</b>												
<b>3P, 3P+N</b>												
<b>Selectivity limit (A)</b>												
iC40	2			12	16	30	60	110	180	240	340	450
iC40 N	4					10	40	64	120	160	220	280
Curve B	6						40	64	80	100	130	160
	10							64	80	100	130	160
	13									100	130	160
	16									100	130	160
	20										130	160
	25											160
<b>Selectivity limit (A)</b>												
iC40	2				12	30	60	110	180	240	340	450
iC40 N	4						32	64	120	160	220	280
Curve C	6							51	80	100	130	160
	10								64	80	130	160
	13										102	128
	16										102	128
	20											128
<b>Selectivity limit (A)</b>												
iC40	2					19	60	110	180	240	340	450
iC40 N	4							51	120	160	220	280
Curve D	6								64	80	130	160
	10										102	128
	13											128
	16											128

4000 Selectivity limit = 4 kA.

No selectivity.

**Note:** if you cannot find your combination, refer to the selection table on page A-12

# Selectivity table

Upstream: iC60N/H/L curve C

Downstream: iC40, iC40 N curves B, C, D

A

## 220-240/380-415 V AC

Upstream		iC60N/H/L										
		Curve C										
In (A)		1	2	3	4	6	10	16	20	25	32	40
<b>Downstream 1P+N</b>												
<b>3P, 3P+N</b>												
<b>Selectivity limit (A)</b>												
iC40	2			24	32	48	140	270	350	510	820	830
iC40 N	4					48	80	130	240	320	480	510
Curve B	6						80	130	160	200	320	380
	10							130	160	200	260	320
	13								160	200	260	320
	16								160	200	260	320
	20										260	320
	25											320
<b>Selectivity limit (A)</b>												
iC40	2			24	32	48	140	270	350	510	820	830
iC40 N	4					10	80	130	240	320	480	510
Curve C	6						80	130	160	200	320	380
	10							130	160	200	260	320
	13								45	200	260	320
	16								45	200	260	320
	20										260	320
	25											320
<b>Selectivity limit (A)</b>												
iC40	2				25	48	140	270	350	510	820	830
iC40 N	4						80	130	240	320	480	510
Curve D	6							128	160	200	320	380
	10								128	200	260	320
	13									141	153	320
	16									141	153	320
	20											256

4000 Selectivity limit = 4 kA.

No selectivity.

Note: if you cannot find your combination, refer to the selection table on page A-12



# Selectivity table

Upstream: iC60N/H/L curve D

Downstream: iC40, iC40 N curves B, C, D

## 220-240/380-415 V AC



Upstream		iC60N/H/L										
		Curve D										
In (A)		1	2	3	4	6	10	16	20	25	32	40
<b>Downstream 1P+N</b>												
<b>3P, 3P+N</b>												
<b>Selectivity limit (A)</b>												
iC40	2			36	48	130	250	490	780	1100	1600	2300
iC40 N	4					72	120	330	500	670	970	1400
Curve B	6						120	190	390	520	740	1000
	10							190	240	300	580	810
	13									300	380	480
	16									300	380	480
	20										380	480
	25											480
	32											480
<b>Selectivity limit (A)</b>												
iC40	2			36	48	130	250	490	780	1100	1600	2300
iC40 N	4					10	120	330	500	670	970	1400
Curve C	6							190	390	520	740	1000
	10							190	240	300	580	810
	13									300	380	480
	16									300	380	480
	20										380	480
	25											480
<b>Selectivity limit (A)</b>												
iC40	2			36	48	130	250	490	780	1100	1600	2300
iC40 N	4					10	120	330	500	670	970	1400
Curve D	6						120	190	390	520	740	1000
	10							190	240	300	580	810
	13									300	380	480
	16									300	380	480
	20										380	480
	25											480

4000 Selectivity limit = 4 kA.

No selectivity.

Note: if you cannot find your combination, refer to the selection table on page A-12

# Selectivity table

Upstream: iC60N/H/L curve B

Downstream: iCV40 N, iCV40 H curves B, C

A

## 220-240/380-415 V AC

Upstream		iC60N/H/L										
		Curve B										
In (A)		1	2	3	4	6	10	16	20	25	32	40
<b>Downstream</b>												
<b>1P+N</b>												
<b>3P, 3P+N</b>												
<b>Selectivity limit (A)</b>												
iCV40 N	2			12	16	30	60	110	180	240	340	450
iCV40 H	4					10	40	64	120	160	220	280
Curve B	6						40	64	80	100	130	160
	10							64	80	100	130	160
	13									100	130	160
	16									100	130	160
	20										130	160
	25											160
<b>Selectivity limit (A)</b>												
iCV40 N	2			12	30	60	110	180	240	340	450	
iCV40 H	4					32	64	120	160	220	280	
Curve C	6						51	80	100	130	160	
	10							64	80	130	160	
	13									102	128	
	16									102	128	
	20										128	

4000 Selectivity limit = 4 kA.

No selectivity.

Note: if you cannot find your combination, refer to the selection table on page A-12

# Selectivity table

Upstream: iC60N/H/L curve C

Downstream: iCV40 N, iCV40 H curves B, C

## 220-240/380-415 V AC



Upstream		iC60N/H/L										
		Curve C										
In (A)		1	2	3	4	6	10	16	20	25	32	40

Downstream		1P+N										
		3P, 3P+N										

Selectivity limit (A)												
iCV40 N	2			24	32	48	140	270	350	510	820	830
iCV40 H	4					48	80	130	240	320	480	510
Curve B	6						80	130	160	200	320	380
	10							130	160	200	260	320
	13								160	200	260	320
	16								160	200	260	320
	20										260	320
	25											320
Selectivity limit (A)												
iCV40 N	2			24	32	48	140	270	350	510	820	830
iCV40 H	4					10	80	130	240	320	480	510
Curve C	6						80	130	160	200	320	380
	10							130	160	200	260	320
	13								45	200	260	320
	16								45	200	260	320
	20										260	320
	25											320

4000 Selectivity limit = 4 kA.

No selectivity.

Note: if you cannot find your combination, refer to the selection table on page A-12

# Selectivity table

Upstream: iC60N/H/L curve D

Downstream: iCV40 N, iCV40 H curves B, C

A

## 220-240/380-415 V AC

Upstream		iC60N/H/L Curve D										
In (A)		1	2	3	4	6	10	16	20	25	32	40
<b>Downstream 1P+N 3P, 3P+N</b>												
<b>Selectivity limit (A)</b>												
iCV40 N	2			36	48	130	250	490	780	1100	1600	2300
iCV40 H	4					72	120	330	500	670	970	1400
Curve B	6						120	190	390	520	740	1000
	10							190	240	300	580	810
	13									300	380	480
	16									300	380	480
	20										380	480
	25											480
	32											480
<b>Selectivity limit (A)</b>												
iCV40 N	2			36	48	130	250	490	780	1100	1600	2300
iCV40 H	4					10	120	330	500	670	970	1400
Curve C	6							190	390	520	740	1000
	10							190	240	300	580	810
	13									300	380	480
	16									300	380	480
	20										380	480
	25											480

4000 Selectivity limit = 4 kA.

No selectivity.

Note: if you cannot find your combination, refer to the selection table on page A-12

# Selectivity table

Upstream: iC60N/H/L curve B

Downstream: iC60N/H/L curves B, C, D

## 220-240/380-415 V AC



Upstream	iC60N/H/L													
	Curve B													
In (A)	1	2	3	4	6	10	13	16	20	25	32	40	50	63

Downstream	1P, 1P+N, 2P (380-415 V) two-phase network 3P, 3P+N, 4P
------------	---

Selectivity limit (A)															
iC60N/H/L	0.5	4	10	40	60	T	T	T	T	T	T	T	T	T	T
Curve B	1		10	12	16	40	70	120	170	210	300	780	1300	1700	4000
	2			12	16	30	60	90	130	140	200	370	520	630	960
	3					30	40	70	90	120	150	250	380	460	670
	4					30	40	52	90	80	100	250	310	380	470
	6						40	52	64	80	100	190	290	300	440
	10								64	80	100	130	240	200	380
	13									80	100	130	240	200	250
	16										100	130	160	200	250
	20											130	160	200	250
	25												160	200	250
	32													200	250
	40														250

Selectivity limit (A)															
iC60N/H/L	0.5		10	40	60	T	T	T	T	T	T	T	T	T	T
Curve C	1				16	30	70	120	170	210	300	780	1300	1700	4000
	2				16	18	60	90	130	160	200	370	520	630	960
	3					15	40	70	90	120	150	250	380	460	670
	4						27	52	90	80	100	250	310	380	470
	6								51	80	100	190	290	300	440
	10									64	80	130	240	200	250
	13											102	160	200	250
	16											102	128	200	250
	20												128	160	250
	25													160	200
	32														200

Selectivity limit (A)															
iC60N/H/L	0.5			30	50	T	T	T	T	T	T	T	T	T	T
Curve D	1				12	30	60	120	170	210	300	780	1300	1700	4000
	2					19	40	70	110	140	180	370	520	630	860
	3						31	41	90	120	150	250	380	460	670
	4								48	80	100	220	310	340	470
	6									64	80	190	240	300	380
	10											100	128	200	250
	13												128	160	250
	16												128	160	200
	20													160	200
	25														200

4000 Selectivity limit = 4 kA.

T Total selectivity.

No selectivity.

Note: if you cannot find your combination, refer to the selection table on page A-12

# Selectivity table

Upstream: iC60N/H/L curve B

Downstream: iC60N/H/L curves B, C, D



## 220-240/380-415 V AC

Upstream		iC60N/H/L													
		Curve B													
In (A)		1	2	3	4	6	10	13	16	20	25	32	40	50	63
<b>Downstream 2P (220-240 V) single-phase network</b>															
<b>Selectivity limit (A)</b>															
iC60N/H/L	0.5	4	210	T	T	T	T	T	T	T	T	T	T	T	T
Curve B	1		10	20	20	60	110	260	530	790	2000	T	T	T	T
	2			12	16	30	70	140	200	250	400	880	1700	2500	5300
	3					30	40	90	130	160	250	550	800	1100	1400
	4						40	70	110	120	180	370	520	630	960
	6						40	52	64	80	100	270	380	460	630
	10								64	80	100	190	290	300	440
	13									80	100	130	240	200	380
	16										100	130	240	200	250
	20											130	160	200	250
	25												160	200	250
	32													200	250
	40														250
<b>Selectivity limit (A)</b>															
iC60N/H/L	0.5		170	T	T	T	T	T	T	T	T	T	T	T	T
Curve C	1				20	60	110	260	530	790	2000	T	T	T	T
	2				16	18	70	140	200	250	400	880	1700	2500	5300
	3					15	40	90	130	160	230	550	800	1100	1400
	4						27	70	90	120	180	370	520	630	860
	6								51	80	100	230	380	410	630
	10									64	80	130	240	300	440
	13											102	240	200	380
	16											102	128	200	250
	20												128	160	250
	25													160	200
	32														200
<b>Selectivity limit (A)</b>															
iC60N/H/L	0.5			T	T	T	T	T	T	T	T	T	T	T	T
Curve D	1				12	50	110	260	530	790	2000	T	T	T	T
	2					19	60	120	200	250	350	1100	1700	2500	5300
	3						31	41	110	140	230	490	800	960	1400
	4								48	80	150	310	450	630	860
	6									64	80	230	330	410	500
	10											100	128	200	380
	13												128	160	250
	16												128	160	200
	20													160	200
	25														200

4000 Selectivity limit = 4 kA.

T Total selectivity.

No selectivity.

**Note:** the selectivity limits given in the table must be compared to the phase/neutral fault current (Ik1).

If the max. phase/earth fault current (If) is high, the selectivity of this fault current should also be verified by referring to the limits given in the dark green part of the table.

# Selectivity table

Upstream: iC60N/H/L curve C

Downstream: iC60N/H/L curves B, C, D

## 220-240/380-415 V AC



Upstream	iC60N/H/L													
	Curve C													
In (A)	1	2	3	4	6	10	13	16	20	25	32	40	50	63

Downstream	1P, 1P+N, 2P (380-415 V) two-phase network 3P, 3P+N, 4P													
------------	---	--	--	--	--	--	--	--	--	--	--	--	--	--

Selectivity limit (A)														
iC60N/H/L	0.5	8	60	T	T	T	T	T	T	T	T	T	T	T
Curve B	1		16	24	32	70	180	210	370	590	1100	2400	7000	T
	2			24	32	48	140	160	220	310	460	780	1200	2000
	3				5	48	120	104	190	280	380	580	820	1400
	4					14	80	104	130	240	300	430	590	1000
	6						80	104	130	160	200	380	480	770
	10								104	130	160	200	260	320
	13									160	200	260	320	600
	16										200	260	320	600
	20											260	320	400
	25												320	400
	32													400
	40													500

Selectivity limit (A)														
iC60N/H/L	0.5	8	50	T	T	T	T	T	T	T	T	T	T	T
Curve C	1		16	24	32	70	180	210	370	590	1100	2400	7900	T
	2			24	32	48	120	160	220	310	460	780	1200	2000
	3					16	80	104	190	280	380	480	820	1400
	4					14	80	104	130	160	300	430	590	1000
	6						80	104	130	160	200	380	480	770
	10								130	160	200	260	320	680
	13									55	200	260	320	600
	16										71	260	320	400
	20											260	320	400
	25												127	400
	32													168
	40													500

Selectivity limit (A)														
iC60N/H/L	0.5		50	T	T	T	T	T	T	T	T	T	T	T
Curve D	1			24	32	70	180	210	370	590	1100	2400	7900	T
	2				25	48	120	160	220	310	460	680	1200	2000
	3					15	80	104	130	240	380	480	710	1400
	4						28	100	130	160	300	430	590	1000
	6								130	160	200	260	480	770
	10									73	200	260	320	600
	13										79	260	320	600
	16										71	194	320	400
	20											135	400	500
	25													174
	32													277
	40													

4000 Selectivity limit = 4 kA.

T Total selectivity.

No selectivity.

Note: if you cannot find your combination, refer to the selection table on page A-12

# Selectivity table

Upstream: iC60N/H/L curve C

Downstream: iC60N/H/L curves B, C, D



## 220-240/380-415 V AC

Upstream		iC60N/H/L													
		Curve C													
In (A)		1	2	3	4	6	10	13	16	20	25	32	40	50	63
<b>Downstream 2P (220-240 V) single-phase network</b>															
<b>Selectivity limit (A)</b>															
iC60N/H/L	0.5	20	T	T	T	T	T	T	T	T	T	T	T	T	T
Curve B	1		20	40	50	120	540	940	2700	T	T	T	T	T	T
	2			24	32	70	210	260	430	800	1500	3600	7900	52000	53000
	3				5	48	140	180	250	450	710	1200	2100	11000	9800
	4					14	120	160	220	310	460	680	940	2000	2000
	6						80	104	130	240	350	510	770	1300	1100
	10							104	130	160	200	380	550	930	950
	13									160	200	260	480	770	760
	16										200	260	320	400	500
	20											260	320	400	500
	25												320	400	500
	32													400	500
	40														500
<b>Selectivity limit (A)</b>															
iC60N/H/L	0.5	20	T	T	T	T	T	T	T	T	T	T	T	T	T
Curve C	1		20	40	50	120	540	940	2700	T	T	T	T	T	T
	2			24	32	70	210	260	430	660	1500	3600	7900	60000	53000
	3					16	140	180	250	380	710	1200	2100	11000	9800
	4					14	120	104	190	310	460	680	940	2000	2000
	6						80	104	130	160	350	510	620	1300	1100
	10								130	160	200	260	480	770	850
	13									55	200	260	480	770	760
	16										78	260	320	400	500
	20											260	320	400	500
	25												127	400	500
	32													168	500
	40														500
<b>Selectivity limit (A)</b>															
iC60N/H/L	0.5		T	T	T	T	T	T	T	T	T	T	T	T	T
Curve D	1			30	50	120	540	940	2700	T	T	T	T	T	T
	2				25	48	210	260	430	800	1500	3600	7900	60000	53000
	3					15	120	160	250	380	630	1200	2100	11000	9800
	4						28	100	190	280	460	680	940	2000	2000
	6								130	160	300	450	620	1100	1100
	10									73	200	260	480	770	850
	13										79	260	320	680	760
	16										71	194	320	400	500
	20												135	400	500
	25													174	500
	32														277
	40														

4000 Selectivity limit = 4 kA.

T Total selectivity.

No selectivity.

Note: the selectivity limits given in the table must be compared to the phase/neutral fault current (Ik1).

If the max. phase/earth fault current (If) is high, the selectivity of this fault current should also be verified by referring to the limits given in the dark green part of the table.



# Selectivity table

Upstream: iC60N/H/L curve D

Downstream: iC60N/H/L curves B, C, D

## 220-240/380-415 V AC



Upstream	iC60N/H/L													
	Curve D													
In (A)	1	2	3	4	6	10	13	16	20	25	32	40	50	63

<b>Downstream</b>	<b>1P, 1P+N, 2P (380-415 V) two-phase network 3P, 3P+N, 4P</b>
-------------------	--

Selectivity limit (A)															
iC60N/H/L	0.5	20	T	T	T	T	T	T	T	T	T	T	T	T	T
Curve B	1		30	50	70	150	290	510	770	2000	3900	T	T	T	T
	2			36	48	110	210	300	450	730	890	1400	2300	5000	6800
	3				5	72	180	230	330	550	670	1100	1300	2800	4300
	4					72	120	160	290	410	560	840	1000	2000	2400
	6						120	160	190	360	450	660	910	1300	1600
	10							28	190	240	300	380	720	1100	1400
	13									240	300	380	480	900	1100
	16										300	380	480	900	1100
	20											380	480	600	760
	25												480	600	760
	32													600	760
	40													600	760

Selectivity limit (A)															
iC60N/H/L	0.5	20	T	T	T	T	T	T	T	T	T	T	T	T	T
Curve C	1		30	50	70	150	290	510	770	2000	3900	T	T	T	T
	2			36	48	110	210	300	450	730	890	1600	2300	5000	6800
	3				5	15	120	230	330	550	670	1100	1300	2800	4300
	4					13	120	160	290	410	560	710	1000	2000	2400
	6						120	160	190	360	450	660	910	1300	1600
	10							28	49	240	300	380	720	1100	1100
	13									52	300	380	480	900	1100
	16										71	380	480	900	760
	20											380	480	600	760
	25												105	600	760
	32													153	760
	40														760

Selectivity limit (A)															
iC60N/H/L	0.5	20	T	T	T	T	T	T	T	T	T	T	T	T	T
Curve D	1		30	50	70	150	290	510	770	2000	3900	T	T	T	T
	2			36	48	110	210	300	370	640	890	1600	2300	5000	6800
	3					15	120	230	330	450	670	970	1300	2800	3800
	4					13	28	160	190	410	560	710	1000	1600	2400
	6						32	160	190	240	450	580	810	1300	1600
	10								49	73	300	380	480	1100	1100
	13									52	80	380	480	900	1100
	16										71	380	480	900	760
	20											105	135	600	760
	25												105	174	760
	32													153	760
	40														245

4000 Selectivity limit = 4 kA.

T Total selectivity.

No selectivity.

Note: if you cannot find your combination, refer to the selection table on page A-12

# Selectivity table

Upstream: iC60N/H/L curve D

Downstream: iC60N/H/L curves B, C, D



## 220-240/380-415 V AC

Upstream	iC60N/H/L													
	Curve D													
In (A)	1	2	3	4	6	10	13	16	20	25	32	40	50	63

**Downstream 2P (220-240 V) single-phase network**

Selectivity limit (A)															
iC60N/H/L Curve B	0.5	T	T	T	T	T	T	T	T	T	T	T	T	T	T
	1		50	100	130	340	1600	10000	T	T	T	T	T	T	T
	2			50	80	150	350	650	1100	2600	5800	16000	45000	T	T
	3				5	110	240	370	530	920	1600	3800	9500	T	T
	4					72	180	270	370	640	890	1400	2300	7100	12000
	6						120	160	290	480	590	900	1300	2200	2600
	10							28	190	360	450	660	910	1500	1900
	13									240	450	580	810	1300	1600
	16										300	380	720	1100	1400
	20											380	480	900	1100
	25												480	900	760
	32													600	760
	40														760
	Selectivity limit (A)														
iC60N/H/L Curve C	0.5	T	T	T	T	T	T	T	T	T	T	T	T	T	T
	1		50	100	130	340	1600	10000	T	T	T	T	T	T	T
	2			50	70	150	350	580	1100	2600	5800	16000	45000	T	T
	3				5	15	240	370	530	920	1600	3800	9500	T	T
	4					13	180	270	370	640	890	1400	1900	7100	12000
	6						120	160	290	480	590	900	1300	2200	2600
	10							28	190	360	450	660	910	1500	1900
	13									52	300	580	810	1300	1600
	16										71	380	720	1100	1400
	20											380	480	900	1100
	25												105	600	760
	32													153	760
	40														760
	Selectivity limit (A)														
iC60N/H/L Curve D	0.5	T	T	T	T	T	T	T	T	T	T	T	T	T	T
	1		40	80	130	340	1600	10000	T	T	T	T	T	T	T
	2			50	70	150	350	650	1200	2600	5800	16000	45000	T	T
	3					15	210	300	530	920	1600	3800	9500	T	T
	4					13	28	230	370	640	890	1400	1900	7100	12000
	6						32	160	190	420	590	900	1100	2200	2600
	10								49	73	450	660	910	1500	1900
	13									52	300	380	720	1300	1600
	16										71	380	480	1100	1400
	20											105	480	900	1100
	25												105	174	760
	32													153	760
	40														245

- 4000 Selectivity limit = 4 kA.
- T Total selectivity.
- No selectivity.

**Note:** the selectivity limits given in the table must be compared to the phase/neutral fault current (Ik1).  
 If the max. phase/earth fault current (If) is high, the selectivity of this fault current should also be verified by referring to the limits given in the dark green part of the table.

# Selectivity table

Upstream: iC60N/H/L curve B

Downstream: iC60 RCBO curves B, C

## 220-240/380-415 V AC



Upstream	iC60N/H/L													
	Curve B													
In (A)	1	2	3	4	6	10	13	16	20	25	32	40	50	63

**Downstream 3P/4P 380-415 V AC**

Selectivity limit (A)																	
iC60 RCBO Curve B	6								40	52	64	80	100	190	290	300	440
	10										64	80	100	130	240	200	380
	13											80	100	130	240	200	250
	16												100	130	160	200	250
	20													130	160	200	250
	25														160	200	250
	32															200	250
	40																200
Selectivity limit (A)																	
iC60 RCBO Curve C	6										51	80	100	190	290	300	440
	10											64	80	130	240	200	250
	13													102	160	200	250
	16													102	128	200	250
	20														128	160	250
	25															160	200
	32																200

4000 Selectivity limit = 4 kA.

No selectivity.

Note: if you cannot find your combination, refer to the selection table on page A-12

# Selectivity table

Upstream: iC60N/H/L curve B

Downstream: iC60 RCBO curves B, C

A

## 220-240/380-415 V AC

Upstream		iC60N/H/L													
		Curve B													
In (A)		1	2	3	4	6	10	13	16	20	25	32	40	50	63
<b>Downstream</b>		<b>2P (220-240 V AC), 2P (220-240 V AC Phase to Neutral) 3P (220-240 V AC Phase to Phase)</b>													
<b>Selectivity limit (A)</b>															
<b>iC60 RCBO</b> Curve B	6						40	52	64	80	100	270	380	460	630
	10								64	80	100	190	290	300	440
	13									80	100	130	240	200	380
	16										100	130	240	200	250
	20											130	160	200	250
	25												160	200	250
	32													200	250
	40														200
<b>Selectivity limit (A)</b>															
<b>iC60 RCBO</b> Curve C	6								51	80	100	230	380	410	630
	10									64	80	130	240	300	440
	13											102	240	200	380
	16											102	128	200	250
	20												128	160	250
	25													160	200
	32														200

4000 Selectivity limit = 4 kA.

No selectivity.

**Note:** the selectivity limits given in the table must be compared to the phase/neutral fault current (Ik1).

If the max. phase/earth fault current (If) is high, the selectivity of this fault current should also be verified by referring to the limits given in the dark green part of the table.

# Selectivity table

Upstream: iC60N/H/L curve C

Downstream: iC60 RCBO curves B, C

## 220-240/380-415 V AC



Upstream	iC60N/H/L													
	Curve C													
In (A)	1	2	3	4	6	10	13	16	20	25	32	40	50	63

**Downstream 3P/4P 380-415 V AC**

Selectivity limit (A)																		
iC60 RCBO Curve B	6									80	104	130	160	200	380	480	770	850
	10										104	130	160	200	260	320	680	500
	13												160	200	260	320	600	500
	16													200	260	320	600	500
	20														260	320	400	500
	25															320	400	500
	32																400	500
	40																	400
Selectivity limit (A)																		
iC60 RCBO Curve C	6									80	104	130	160	200	380	480	770	850
	10											130	160	200	260	320	680	500
	13												55	200	260	320	600	500
	16													71	260	320	400	500
	20														260	320	400	500
	25															127	400	500
	32																168	500
	40																	168

4000 Selectivity limit = 4 kA.

No selectivity.

**Note:** if you cannot find your combination, refer to the selection table on page A-12

# Selectivity table

Upstream: iC60N/H/L curve C

Downstream: iC60 RCBO curves B, C

A

## 220-240/380-415 V AC

Upstream		iC60N/H/L													
		Curve C													
In (A)		1	2	3	4	6	10	13	16	20	25	32	40	50	63
<b>Downstream</b>		<b>2P (220-240 V AC Phase to Neutral)</b>													
		<b>3P (220-240 V AC Phase to Phase)</b>													
<b>Selectivity limit (A)</b>															
<b>iC60 RCBO</b> Curve B	<b>6</b>						80	104	130	240	350	510	770	1300	1100
	<b>10</b>							104	130	160	200	380	550	930	950
	<b>13</b>									160	200	260	480	770	760
	<b>16</b>										200	260	320	400	500
	<b>20</b>											260	320	400	500
	<b>25</b>												320	400	500
	<b>32</b>													400	500
	<b>40</b>														400
<b>Selectivity limit (A)</b>															
<b>iC60 RCBO</b> Curve C	<b>6</b>						80	104	130	160	350	510	620	1300	1100
	<b>10</b>								130	160	200	260	480	770	850
	<b>13</b>									55	200	260	480	770	760
	<b>16</b>										78	260	320	400	500
	<b>20</b>											260	320	400	500
	<b>25</b>												127	400	500
	<b>32</b>													168	500
	<b>40</b>														168

4000 Selectivity limit = 4 kA.

No selectivity.

**Note:** the selectivity limits given in the table must be compared to the phase/neutral fault current (Ik1).

If the max. phase/earth fault current (If) is high, the selectivity of this fault current should also be verified by referring to the limits given in the dark green part of the table.

# Selectivity table

Upstream: iC60N/H/L curve D

Downstream: iC60 RCBO curves B, C

## 220-240/380-415 V AC



Upstream	iC60N/H/L													
	Curve D													
In (A)	1	2	3	4	6	10	13	16	20	25	32	40	50	63

Downstream		3P/4P 380-415 V AC													
Selectivity limit (A)															
iC60 RCBO Curve B	6						120	160	190	360	450	660	910	1300	1600
	10							28	190	240	300	380	720	1100	1400
	13									240	300	380	480	900	1100
	16										300	380	480	900	1100
	20											380	480	600	760
	25												480	600	760
	32													600	760
	40														760
Selectivity limit (A)															
iC60 RCBO Curve C	6						120	160	190	360	450	660	910	1300	1600
	10							28	49	240	300	380	720	1100	1100
	13									52	300	380	480	900	1100
	16										71	380	480	900	760
	20											380	480	600	760
	25												105	600	760
	32													153	760
	40														760

4000 Selectivity limit = 4 kA.

No selectivity.

**Note:** if you cannot find your combination, refer to the selection table on page A-12

# Selectivity table

Upstream: iC60N/H/L curve D

Downstream: iC60 RCBO curves B, C

## 220-240/380-415 V AC

Upstream		iC60N/H/L													
		Curve D													
In (A)		1	2	3	4	6	10	13	16	20	25	32	40	50	63
<b>Downstream</b>		<b>2P (220-240 V AC Phase to Neutral)</b>													
		<b>3P (220-240 V AC Phase to Phase)</b>													
<b>Selectivity limit (A)</b>															
<b>iC60 RCBO</b> Curve B	<b>6</b>						120	160	290	480	590	900	1300	2200	2600
	<b>10</b>							28	190	360	450	660	910	1500	1900
	<b>13</b>									240	450	580	810	1300	1600
	<b>16</b>										300	380	720	1100	1400
	<b>20</b>											380	480	900	1100
	<b>25</b>												480	900	760
	<b>32</b>													600	760
	<b>40</b>														760
<b>Selectivity limit (A)</b>															
<b>iC60 RCBO</b> Curve C	<b>6</b>						120	160	290	480	590	900	1300	2200	2600
	<b>10</b>							28	190	360	450	660	910	1500	1900
	<b>13</b>									52	300	580	810	1300	1600
	<b>16</b>										71	380	720	1100	1400
	<b>20</b>											380	480	900	1100
	<b>25</b>												105	600	760
	<b>32</b>													153	760
	<b>40</b>														760

 4000 Selectivity limit = 4 kA.

 No selectivity.

**Note:** the selectivity limits given in the table must be compared to the phase/neutral fault current ( $I_{k1}$ ).

If the max. phase/earth fault current ( $I_f$ ) is high, the selectivity of this fault current should also be verified by referring to the limits given in the dark green part of the table.



# Selectivity table

Upstream: NG125N/H/L, C120N/H curve B

Downstream: iDPN/ iDPN N curves B, C, D, iDPN N Vigi / iDPN H Vigi curves B, C

220-240/380-415 V AC



Upstream		NG125N/H/L, C120N/H										
		Curve B										
In (A)		10	16	20	25	32	40	50	63	80	100	125

Downstream		1P+N 3P, 3P+N										
------------	--	------------------	--	--	--	--	--	--	--	--	--	--

Selectivity limit (A)

iDPN	1	300	500	700	1000	1500	2000	2500	T	T	T	T
iDPN N	2	150	300	500	700	1000	1500	2000	T	T	T	T
iDPN N Vigi	3	40	64	300	500	700	1000	1500	T	T	T	T
iDPN H Vigi	4	40	64	80	400	500	700	800	3000	T	T	T
Curve B	6	40	64	80	400	500	700	800	3000	T	T	T
	10		64	80	100	130	500	600	1800	3000	T	T
	16				100	130	160	200	1000	2000	3300	3750
	20					52	160	200	1000	1600	2500	3700
	25						59	200	800	1300	2100	3700
	32							200	600	1000	1800	2700
	40								112	320	1600	2400

Selectivity limit (A)

iDPN	1	300	500	700	1000	1500	2000	2500	T	T	T	T
iDPN N	2	150	300	500	700	1000	1500	2000	T	T	T	T
iDPN N Vigi	3	40	64	300	500	700	1000	1500	T	T	T	T
iDPN H Vigi	4	40	64	80	400	500	700	800	3000	T	T	T
Curve C	6		51	80	100	500	700	800	3000	T	T	T
	10				80	130	500	600	1800	3000	4000	T
	16					98	128	200	1000	2000	3300	3700
	20						128	160	1000	1600	2500	3700
	25							160	201	1300	2100	3700
	32								201	256	1800	2700
	40									255	320	2400

Selectivity limit (A)

iDPN	1	300	500	700	1000	1500	2000	2500	T	T	T	T
iDPN N	2	150	300	500	700	1000	1500	2000	T	T	T	T
Curve D	3		64	300	500	700	1000	1500	T	T	T	T
	4			80	400	500	700	800	3000	T	T	T
	6					500	700	800	3000	T	T	T
	10							600	1800	3000	4000	T
	16								201	2000	3300	3700
	20								201	256	2500	3700
	25								201	256	320	3700
	32									256	320	400
	40										320	400

4000 Selectivity limit = 4 kA.

T Total selectivity.

No selectivity.

Note: if you cannot find your combination, refer to the selection table on page A-12

# Selectivity table

Upstream: NG125N/H/L, C120N/H curve C

Downstream: iDPN curves B, C, D, iDPN N Vigì / iDPN H Vigì curves B, C

## 220-240/380-415 V AC

A

Upstream		NG125N/H/L, C120N/H										
		Curve C										
In (A)		10	16	20	25	32	40	50	63	80	100	125
<b>Downstream</b>												
<b>1P+N</b>												
<b>3P, 3P+N</b>												
<b>Selectivity limit (A)</b>												
iDPN	1	300	500	700	1000	T	T	T	T	T	T	T
iDPN N	2	150	300	500	700	1000	1500	T	T	T	T	T
iDPN N Vigì	3	120	200	300	500	700	1000	1500	T	T	T	T
iDPN H Vigì	4	80	130	170	400	500	700	800	3000	T	T	T
Curve B	6	80	130	170	400	500	700	800	3000	T	T	T
	10		130	160	200	350	500	600	1800	3000	T	T
	16				200	270	340	450	1250	2000	3300	3700
	20					52	320	400	1000	1600	2500	3700
	25						59	400	800	1300	2100	3700
	32							95	600	1000	1800	2700
	40								112	700	1600	2400
<b>Selectivity limit (A)</b>												
iDPN	1	300	500	700	1000	T	T	T	T	T	T	T
iDPN N	2	150	300	500	700	1000	1500	T	T	T	T	T
iDPN N Vigì	3	120	200	300	500	700	1000	1500	T	T	T	T
iDPN H Vigì	4	21	200	170	400	500	700	800	3000	4500	4500	T
Curve C	6	18	200	170	400	500	700	800	3000	4500	4500	T
	10		25	160	200	350	500	600	1800	3000	4500	4500
	16				200	270	340	450	1250	2000	3300	3700
	20					52	320	400	1000	1600	2500	3700
	25						59	400	800	1300	2100	3700
	32							95	800	1000	1800	2700
	40								112	257	1600	2400
<b>Selectivity limit (A)</b>												
iDPN	1	300	500	700	1000	T	T	T	T	T	T	T
iDPN N	2	150	300	500	700	1000	1500	T	T	T	T	T
Curve D	3	120	200	300	500	700	1000	1500	T	T	T	T
	4	21	200	170	400	500	700	800	3000	4500	4500	T
	6				400	500	700	800	3000	4500	4500	T
	10				200	450	500	600	1800	3000	4500	4500
	16							450	1000	2000	3300	3700
	20								1000	1600	2500	3700
	25								800	1300	2100	3700
	32										1800	2700
	40											2400

4000 Selectivity limit = 4 kA.

T Total selectivity.

No selectivity.

Note: if you cannot find your combination, refer to the selection table on page A-12

# Selectivity table

Upstream: NG125N/H/L, C120N/H curve D

Downstream: iDPN/ iDPN N curves B, C, D, iDPN N Vigi / iDPN H Vigi curves B, C

## 220-240/380-415 V AC



Upstream	NG125N/H/L, C120N/H										
	Curve D										
In (A)	10	16	20	25	32	40	50	63	80	100	125

Downstream	1P+N											
	3P, 3P+N											

Selectivity limit (A)

iDPN	1	350	T	T	T	T	T	T	T	T	T	T
iDPN N	2	240	770	830	2000	2200	4800	T	T	T	T	T
iDPN N Vigi	3	180	610	640	1600	1700	3800	T	T	T	T	T
iDPN H Vigi	4	120	450	500	1000	1100	1900	4600	T	T	T	T
Curve B	6	120	340	360	730	740	1200	2600	4700	T	T	T
	10		192	240	550	580	860	1600	2800	3500	5600	T
	16				300	380	480	1200	1900	2400	3600	4200
	20					380	480	1000	1500	2000	2900	3300
	25						59	950	1400	1700	2600	2900
	32							600	1100	1600	2200	2600
	40								756	1400	2100	2400

Selectivity limit (A)

iDPN	1	350	T	T	T	T	T	T	T	T	T	T
iDPN N	2	240	770	830	2000	2200	4800	T	T	T	T	T
iDPN N Vigi	3	180	610	640	1600	1700	3800	T	T	T	T	T
iDPN H Vigi	4	120	450	500	1000	1100	1900	4600	T	T	T	T
Curve C	6	18	192	360	730	740	1200	2600	4700	T	T	T
	10		29	240	550	580	860	1600	2800	3500	5600	T
	16				49	380	480	1200	1900	2400	3600	4200
	20					52	480	1000	1500	2000	2900	3300
	25						59	600	1400	1700	2600	2900
	32							95	1100	1600	2200	2600
	40								756	960	2100	2400

Selectivity limit (A)

iDPN	1	350	T	T	T	T	T	T	T	T	T	T
iDPN N	2	240	770	830	2000	2200	4800	T	T	T	T	T
Curve D	3	120	610	640	1600	1700	3800	T	T	T	T	T
	4	21	450	500	1000	1100	1900	4600	T	T	T	T
	6	18	192	360	730	740	1200	2600	4700	T	T	T
	10		25	240	300	580	860	1600	2800	3500	5600	T
	16				49	380	480	1200	1900	2400	3600	4200
	20					52	480	1000	1500	2000	2900	3300
	25						59	600	756	1700	2600	2900
	32							95	756	1600	2200	2600
	40								756	960	2100	2400

4000 Selectivity limit = 4 kA.

T Total selectivity.

No selectivity.

Note: if you cannot find your combination, refer to the selection table on page A-12

# Selectivity table

Upstream: NG125N/H/L, C120N/H curve B

Downstream: iC40, iC40 N curves B, C, D & iCV40N curves B, C

## 220-240/380-415 V AC

A

Upstream		NG125N/H/L, C120N/H										
		Curve B										
In (A)		10	16	20	25	32	40	50	63	80	100	125

Downstream		1P+N 3P, 3P+N										
------------	--	------------------	--	--	--	--	--	--	--	--	--	--

Selectivity limit (A)												
iC40	2	150	300	500	700	1000	1500	2000	T	T	T	T
iC40 N	4	40	64	80	400	500	700	800	3000	T	T	T
iCV40 N	6	40	64	80	400	500	700	800	3000	T	T	T
Curve B	10		64	80	100	130	500	600	1800	3000	T	T
	13				100	130	160	200	1000	2000	3300	3750
	16				100	130	160	200	1000	2000	3300	3750
	20					52	160	200	1000	1600	2500	3700
	25						59	200	800	1300	2100	3700
	32							200	600	1000	1800	2700
	40								112	320	1600	2400
Selectivity limit (A)												
iC40	2	150	300	500	700	1000	1500	2000	T	T	T	T
iC40 N	4	40	64	80	400	500	700	800	3000	T	T	T
iCV40 N	6		51	80	100	500	700	800	3000	T	T	T
Curve C	10				80	130	500	600	1800	3000	4000	T
	13					98	128	200	1000	2000	3300	3700
	16					98	128	200	1000	2000	3300	3700
	20						128	160	1000	1600	2500	3700
	25							160	201	1300	2100	3700
	32								201	256	1800	2700
	40									255	320	2400
Selectivity limit (A)												
iC40	2	150	300	500	700	1000	1500	2000	T	T	T	T
iC40 N	4			80	400	500	700	800	3000	T	T	T
Curve B	6					500	700	800	3000	T	T	T
	10							600	1800	3000	4000	T
	13								201	2000	3300	3700
	16								201	2000	3300	3700
	20								201	256	2500	3700
	25								201	256	320	3700
	32									256	320	400
	40										320	400

4000 Selectivity limit = 4 kA.

T Total selectivity.

No selectivity.

Note: if you cannot find your combination, refer to the selection table on page A-12

# Selectivity table

Upstream: NG125N/H/L, C120N/H curve C

Downstream: iC40, iC40 N curves B, C, D & iCV40N curves B, C

## 220-240/380-415 V AC



Upstream		NG125N/H/L, C120N/H										
		Curve C										
In (A)		10	16	20	25	32	40	50	63	80	100	125
<b>Downstream 1P+N</b>												
<b>3P, 3P+N</b>												
<b>Selectivity limit (A)</b>												
iC40	2	150	300	500	700	1000	1500	T	T	T	T	T
iC40 N	4	80	130	170	400	500	700	800	3000	T	T	T
iCV40 N	6	80	130	170	400	500	700	800	3000	T	T	T
Curve B	10		130	160	200	350	500	600	1800	3000	T	T
	13				200	270	340	450	1250	2000	3300	3700
	16				200	270	340	450	1250	2000	3300	3700
	20					52	320	400	1000	1600	2500	3700
	25						59	400	800	1300	2100	3700
	32							95	600	1000	1800	2700
	40								112	700	1600	2400
<b>Selectivity limit (A)</b>												
iC40	2	150	300	500	700	1000	1500	T	T	T	T	T
iC40 N	4	21	200	170	400	500	700	800	3000	4500	4500	T
iCV40 N	6	18	200	170	400	500	700	800	3000	4500	4500	T
Curve C	10		25	160	200	350	500	600	1800	3000	4500	4500
	13				200	270	340	450	1250	2000	3300	3700
	16				200	270	340	450	1250	2000	3300	3700
	20					52	320	400	1000	1600	2500	3700
	25						59	400	800	1300	2100	3700
	32							95	800	1000	1800	2700
	40								112	257	1600	2400
<b>Selectivity limit (A)</b>												
iC40	2	150	300	500	700	1000	1500	T	T	T	T	T
iC40 N	4	21	200	170	400	500	700	800	3000	4500	4500	T
Curve D	6				400	500	700	800	3000	4500	4500	T
	10				200	450	500	600	1800	3000	4500	4500
	13							450	1000	2000	3300	3700
	16							450	1000	2000	3300	3700
	20								1000	1600	2500	3700
	25								800	1300	2100	3700
	32										1800	2700
	40											2400

4000 Selectivity limit = 4 kA.

T Total selectivity.

No selectivity.

Note: if you cannot find your combination, refer to the selection table on page A-12

# Selectivity table

Upstream: NG125N/H/L, C120N/H curve D

Downstream: iC40, iC40 N curves B, C, D & iCV40N curves B, C

## 220-240/380-415 V AC

A

Upstream		NG125N/H/L, C120N/H										
		Curve D										
In (A)		10	16	20	25	32	40	50	63	80	100	125

Downstream		1P+N 3P, 3P+N										
------------	--	------------------	--	--	--	--	--	--	--	--	--	--

Selectivity limit (A)												
iC40	2	240	770	830	2000	2200	4800	T	T	T	T	T
iC40 N	4	120	450	500	1000	1100	1900	4600	T	T	T	T
iCV40 N	6	120	340	360	730	740	1200	2600	4700	T	T	T
Curve B	10		192	240	550	580	860	1600	2800	3500	5600	T
	13				300	380	480	1200	1900	2400	3600	4200
	16				300	380	480	1200	1900	2400	3600	4200
	20					380	480	1000	1500	2000	2900	3300
	25						59	600	1400	1700	2600	2900
	32							600	1100	1600	2200	2600
	40								756	1400	2100	2400
Selectivity limit (A)												
iC40	2	240	770	830	2000	2200	4800	T	T	T	T	T
iC40 N	4	120	450	500	1000	1100	1900	4600	T	T	T	T
iCV40 N	6	18	192	360	730	740	1200	2600	4700	T	T	T
Curve C	10		29	240	550	580	860	1600	2800	3500	5600	T
	13				49	380	480	1200	1900	2400	3600	4200
	16				49	380	480	1200	1900	2400	3600	4200
	20					52	480	1000	1500	2000	2900	3300
	25						59	600	1400	1700	2600	2900
	32							95	1100	1600	2200	2600
	40								756	960	2100	2400
Selectivity limit (A)												
iC40	2	240	770	830	2000	2200	4800	T	T	T	T	T
iC40 N	4	21	450	500	1000	1100	1900	4600	T	T	T	T
Curve D	6	18	192	360	730	740	1200	2600	4700	T	T	T
	10		25	240	300	580	860	1600	2800	3500	5600	T
	13				49	380	480	1200	1900	2400	3600	4200
	16				49	380	480	1200	1900	2400	3600	4200
	20					52	480	1000	1500	2000	2900	3300
	25						59	600	756	1700	2600	2900
	32							95	756	1600	2200	2600
	40								756	960	2100	2400

4000 Selectivity limit = 4 kA.

T Total selectivity.

No selectivity.

Note: if you cannot find your combination, refer to the selection table on page A-12

# Selectivity table

Upstream: NG125N/H/L, C120N/H curve B

Downstream: iC60N/H/L curves B, C, D

## 220-240/380-415 V AC



Upstream	NG125N/H/L, C120N/H										
	Curve B										
In (A)	10	16	20	25	32	40	50	63	80	100	125

Downstream	1P, 1P+N, 2P (380-415 V) two-phase network 3P, 3P+N, 4P
------------	---

**Selectivity limit (A)**

iC60N/H/L Curve B	0.5	T	T	T	T	T	T	T	T	T	T	T
	1	70	150	210	350	550	2000	2500	T	T	T	T
	2	60	110	140	230	310	590	630	1200	2100	3900	9700
	3	40	90	120	180	220	380	460	770	1400	2000	5300
	4	40	64	80	150	190	310	380	570	940	1400	2400
	6	15	64	80	100	130	290	300	440	620	930	1700
	10		22	80	100	130	200	200	380	550	770	1300
	13			28	100	130	160	200	380	480	680	1100
	16				35	130	160	200	250	320	600	940
	20					46	160	200	250	320	400	850
	25						56	200	250	320	400	750
	32							80	250	320	400	500
	40								250	320	400	500
	50									320	400	500
	63										400	500

**Selectivity limit (A)**

iC60N/H/L Curve C	0.5	T	T	T	T	T	T	T	T	T	T	T
	1	70	150	210	350	550	2000	2500	T	T	T	T
	2	40	110	140	230	250	590	630	1200	2100	3900	9700
	3	30	64	120	180	220	380	460	770	1400	2000	5300
	4		64	80	150	190	310	340	570	940	1400	2400
	6			80	100	130	290	300	440	620	930	1700
	10					130	160	200	380	550	770	1100
	13						160	200	250	480	680	940
	16							200	250	320	600	940
	20									320	400	850
	25									320	400	750
	32											500
	40											500

**Selectivity limit (A)**

iC60N/H/L Curve D	0.5	T	T	T	T	T	T	T	T	T	T	T
	1	60	150	210	350	550	2000	2500	T	T	T	T
	2	40	90	140	200	250	520	630	1200	2100	3900	9700
	3		64	80	180	220	380	380	770	1200	2000	5300
	4			80	150	190	310	340	570	820	1100	2400
	6					130	240	200	440	620	930	1700
	10							200	380	480	770	1100
	13								250	480	680	940
	16									320	600	940
	20										400	750
	25											500

4000 Selectivity limit = 4 kA.

T Total selectivity.

No selectivity.

Note: if you cannot find your combination, refer to the selection table on page A-12

# Selectivity table

Upstream: NG125N/H/L, C120N/H curve B

Downstream: iC60N/H/L curves B, C, D



## 220-240/380-415 V AC

Upstream	NG125N/H/L, C120N/H										
	Curve B										
In (A)	10	16	20	25	32	40	50	63	80	100	125

Downstream	2P (220-240 V) single-phase network										
------------	-------------------------------------	--	--	--	--	--	--	--	--	--	--

Selectivity limit (A)												
iC60N/H/L Curve B	0.5	T	T	T	T	T	T	T	T	T	T	T
	1	120	490	T	T	T	T	T	T	T	T	T
	2	60	160	350	500	1200	4200	8100	T	T	T	T
	3	40	110	170	250	520	1300	1900	6700	T	T	T
	4	40	64	80	190	280	630	750	1400	2700	6200	T
	6	15	64	80	150	150	350	430	810	1400	2100	6100
	10		22	80	100	130	160	200	500	840	1300	2500
	13			28	100	130	240	200	440	770	1100	1900
	16				35	130	160	200	380	520	770	1400
	20					46	160	200	250	320	600	1000
	25						56	200	250	320	400	890
	32							80	250	320	400	840
	40								250	320	400	790
50									320	400	750	
63											500	
Selectivity limit (A)												
iC60N/H/L Curve C	0.5	T	T	T	T	T	T	T	T	T	T	T
	1	120	490	T	T	T	T	T	T	T	T	T
	2	60	160	350	500	1200	4200	8100	T	T	T	T
	3	30	110	170	250	520	1300	1900	6700	T	T	T
	4		64	80	190	280	630	750	1400	2700	6200	T
	6			80	150	150	350	430	810	1400	2100	6100
	10					130	160	200	500	840	1300	2500
	13						160	200	440	620	1100	1900
	16							200	380	520	770	1400
	20									320	600	1000
	25									320	400	890
	32											840
	40											500
Selectivity limit (A)												
iC60N/H/L Curve D	0.5	T	T	T	T	T	T	T	T	T	T	T
	1	120	490	T	T	T	T	T	T	T	T	T
	2	60	160	350	500	1200	4200	8100	T	T	T	T
	3		110	170	250	520	1300	1900	6700	T	T	T
	4			80	190	280	630	750	1400	2700	6200	T
	6					150	350	430	810	1400	2100	6100
	10							200	500	840	1300	2500
	13								380	620	930	1900
	16									520	770	1400
	20										600	1000
	25											890

- 4000 Selectivity limit = 4 kA.
- T Total selectivity.
- No selectivity.

**Note:** the selectivity limits given in the table must be compared to the phase/neutral fault current (Ik1).  
 If the max. phase/earth fault current (If) is high, the selectivity of this fault current should also be verified by referring to the limits given in the dark green part of the table.



# Selectivity table

Upstream: NG125N/H/L, C120N/H curve C

Downstream: iC60N/H/L curves B, C, D

## 220-240/380-415 V AC



Upstream		NG125N/H/L										
		Curve C										
In (A)		10	16	20	25	32	40	50	63	80	100	125

Downstream		1P, 1P+N, 2P (380-415 V) two-phase network 3P, 3P+N, 4P										
------------	--	---	--	--	--	--	--	--	--	--	--	--

**Selectivity limit (A)**

iC60N/H/L Curve B		0.5	T	T	T	T	T	T	T	T	T	T
1	140	490	920	2300	T	T	T	T	T	T	T	T
2	80	250	380	550	1800	2400	8800	10000	13000	T	T	T
3	80	190	280	380	1200	1400	4600	8000	8500	14000	T	T
4	80	130	240	300	800	820	2000	2300	3400	7000	13000	T
6	15	130	160	200	610	650	1400	2300	2300	3600	6400	T
10		22	160	200	500	510	1100	1300	1600	2200	3600	T
13			28	200	460	470	930	1100	1400	2000	2600	T
16				35	380	430	770	950	1200	1700	2300	T
20					46	320	680	850	960	1500	2100	T
25						56	600	760	960	1200	1800	T
32							80	500	640	1200	1500	T
40								130	640	800	1500	T
50									640	800	1500	T
63										800	1000	T

**Selectivity limit (A)**

iC60N/H/L Curve C		0.5	T	T	T	T	T	T	T	T	T	T
1	140	490	920	2300	T	T	T	T	T	T	T	T
2	80	250	380	550	2100	2400	8800	10000	13000	T	T	T
3	80	190	280	380	1200	1400	4600	8000	8500	14000	T	T
4	18	130	160	300	800	820	2000	2300	3400	6000	13000	T
6	15	130	160	200	610	650	1400	2300	2300	3600	5500	T
10		22	160	200	500	510	930	1300	1400	2200	3100	T
13			28	51	420	430	770	1100	1200	2000	2600	T
16				35	256	400	770	950	1200	1700	2300	T
20					46	320	680	850	960	1500	1800	T
25						56	400	760	960	1200	1800	T
32							80	500	640	1200	1500	T
40								500	640	800	1500	T
50									640	800	1000	T
63										800	1000	T

**Selectivity limit (A)**

iC60N/H/L Curve D		0.5	T	T	T	T	T	T	T	T	T	T
1	140	490	920	2300	T	T	T	T	T	T	T	T
2	80	250	380	550	1800	2400	8800	10000	13000	T	T	T
3	21	190	280	380	1200	1200	4600	8000	8500	14000	T	T
4	18	130	160	300	740	740	2000	2300	3400	6000	13000	T
6		130	160	200	570	600	1400	1900	1800	3600	5500	T
10				200	450	480	930	1300	1400	2200	3100	T
13					256	430	770	950	1200	1700	2600	T
16						320	770	950	960	1500	2300	T
20							400	760	960	1200	1800	T
25									640	1200	1500	T
32									640	800	1500	T
40										800	1000	T

4000 Selectivity limit = 4 kA.

T Total selectivity.

No selectivity.

Note: if you cannot find your combination, refer to the selection table on page A-12

# Selectivity table

Upstream: NG125N/H/L, C120N/H curve C

Downstream: iC60N/H/L curves B, C, D



## 220-240/380-415 V AC

Upstream	NG125N/H/L										
	Curve C										
In (A)	10	16	20	25	32	40	50	63	80	100	125

**Downstream 2P (220-240 V) single-phase network**

Selectivity limit (A)												
iC60N/H/L Curve B	0.5	T	T	T	T	T	T	T	T	T	T	T
	1	950	T	T	T	T	T	T	T	T	T	T
	2	210	1900	4200	10000	T	T	T	T	T	T	T
	3	120	780	1300	4700	T	T	T	T	T	T	T
	4	80	310	590	1100	4000	13000	T	T	T	T	T
	6	15	190	330	510	1500	2700	7200	9000	9000	T	T
	10		22	160	300	1000	1400	2700	3500	3500	7400	T
	13			28	200	760	910	2000	2700	2700	4900	8100
	16				35	620	620	1600	2700	2700	3600	5500
	20					46	480	1100	1600	1600	2200	3600
	25						56	930	1200	1200	2000	2600
	32							80	930	960	1700	2300
	40								130	960	1400	2000
	50									640	1200	1900
63										1200	1700	
Selectivity limit (A)												
iC60N/H/L Curve C	0.5	T	T	T	T	T	T	T	T	T	T	T
	1	950	T	T	T	T	T	T	T	T	T	T
	2	210	1900	3500	10000	T	T	T	T	T	T	T
	3	80	670	1300	4700	T	T	T	T	T	T	T
	4	18	310	590	1100	3600	13000	T	T	T	T	T
	6	15	190	290	510	1500	2700	7200	9000	9000	T	T
	10		22	160	200	890	1200	2700	3700	3700	6600	T
	13			28	51	760	770	2000	2700	2700	4000	7200
	16				35	256	620	1600	2700	2700	3600	4600
	20					46	320	1100	1400	1400	2200	3600
	25						56	400	1100	1200	2000	2600
	32							80	500	960	1400	2300
	40								500	640	1200	2000
	50									640	800	1700
63											1000	
Selectivity limit (A)												
iC60N/H/L Curve D	0.5	T	T	T	T	T	T	T	T	T	T	T
	1	950	T	T	T	T	T	T	T	T	T	T
	2	210	1700	3500	10000	T	T	T	T	T	T	T
	3	21	550	1300	4700	T	T	T	T	T	T	T
	4	18	310	520	960	3600	13000	T	T	T	T	T
	6		190	240	460	1500	2700	6400	9000	9000	T	T
	10				200	890	1100	2700	3700	3700	6600	T
	13					256	620	2000	2300	2300	4000	7200
	16						320	1400	2300	2300	3100	4600
	20							400	1400	1400	2200	3100
	25									960	1700	2600
	32									640	1400	2000
	40											1800

4000 Selectivity limit = 4 kA.

T Total selectivity.

No selectivity.

**Note:** the selectivity limits given in the table must be compared to the phase/neutral fault current (Ik1).

If the max. phase/earth fault current (If) is high, the selectivity of this fault current should also be verified by referring to the limits given in the dark green part of the table.

# Selectivity table

Upstream: NG125N/H/L, C120N/H curve D

Downstream: iC60N/H/L curves B, C, D

## 220-240/380-415 V AC



Upstream		NG125N/H/L, C120N/H										
		Curve D										
In (A)		10	16	20	25	32	40	50	63	80	100	125

Downstream		1P, 1P+N, 2P (380-415 V) two-phase network 3P, 3P+N, 4P										
------------	--	---	--	--	--	--	--	--	--	--	--	--

**Selectivity limit (A)**

<b>iC60N/H/L</b>		<b>0.5</b>	<b>T</b>	<b>T</b>	<b>T</b>	<b>T</b>	<b>T</b>	<b>T</b>	<b>T</b>	<b>T</b>	<b>T</b>	<b>T</b>
Curve B		1	410	3800	5200	T	T	T	T	T	T	T
		2	240	770	920	2600	2700	7400	14000	T	T	T
		3	180	610	640	1300	1600	3600	11000	T	T	T
		4	120	450	450	890	1100	1900	4100	11000	13000	T
		6	15	340	360	730	740	1300	2600	4700	6200	T
		10		22	240	590	660	910	1700	2600	3500	T
		13			28	300	580	810	1500	2100	2500	4600
		16				35	380	720	1300	1900	2400	3600
		20					46	480	1100	1600	2000	3000
		25						56	900	1400	1700	2400
		32							83	1100	1700	2400
		40								1100	1400	2100
		50									1400	2000
		63										2000

**Selectivity limit (A)**

<b>iC60N/H/L</b>		<b>0.5</b>	<b>T</b>	<b>T</b>	<b>T</b>	<b>T</b>	<b>T</b>	<b>T</b>	<b>T</b>	<b>T</b>	<b>T</b>	<b>T</b>
Curve C		1	410	3800	5200	T	T	T	T	T	T	T
		2	240	770	920	2600	2700	7400	T	T	T	T
		3	21	530	640	1300	1600	3600	11000	T	T	T
		4	18	450	450	890	1100	1900	4100	11000	13000	T
		6	15	340	360	730	740	1300	2200	4700	6200	T
		10		22	240	590	580	910	1700	2600	3500	T
		13			28	51	580	720	1300	2100	2500	4100
		16				35	380	480	1100	1900	2400	3600
		20					46	88	1100	1600	2000	2700
		25						56	600	1400	1700	2400
		32							80	1100	1400	2400
		40								756	1400	2100
		50									960	2000
		63										1800

**Selectivity limit (A)**

<b>iC60N/H/L</b>		<b>0.5</b>	<b>T</b>	<b>T</b>	<b>T</b>	<b>T</b>	<b>T</b>	<b>T</b>	<b>T</b>	<b>T</b>	<b>T</b>	<b>T</b>
Curve D		1	410	3800	5200	T	T	T	T	T	T	T
		2	240	770	920	2600	2700	6300	T	T	T	T
		3	21	530	550	1300	1600	3600	11000	T	T	T
		4	18	370	450	890	970	1600	3700	11000	13000	T
		6	15	340	360	730	740	1100	2200	4700	5400	T
		10		22	240	520	580	810	1500	2600	3000	T
		13			28	51	380	720	1300	2100	2500	4100
		16				35	380	480	1100	1900	2400	3600
		20					46	480	900	1400	1700	2700
		25						56	600	1400	1700	2400
		32							80	1100	1400	2100
		40								756	1400	2100
		50									960	1800
		63										1500

Selectivity limit = 4 kA.

Total selectivity.

No selectivity.

**Note:** if you cannot find your combination, refer to the selection table on page A-12

# Selectivity table

Upstream: NG125N/H/L, C120N/H curve D

Downstream: iC60N/H/L curves B, C, D



## 220-240/380-415 V AC

Upstream	NG125N/H/L, C120N/H										
	Curve D										
In (A)	10	16	20	25	32	40	50	63	80	100	125

**Downstream 2P (220-240 V) single-phase network**

Selectivity limit (A)												
iC60N/H/L Curve B	0.5	T	T	T	T	T	T	T	T	T	T	T
	1	T	T	T	T	T	T	T	T	T	T	T
	2	1200	T	T	T	T	T	T	T	T	T	T
	3	520	3400	3400	T	T	T	T	T	T	T	T
	4	120	1200	1300	5800	5600	T	T	T	T	T	T
	6	15	700	720	1900	1900	6000	11000	T	T	T	T
	10		22	540	1200	1200	2600	4200	10000	T	T	T
	13			28	300	900	1800	3400	7300	8000	T	T
	16				35	740	1500	2200	4700	5400	T	T
	20					46	910	1700	3500	3500	6900	T
	25						56	1500	2500	2500	5200	6800
	32							83	2000	2400	3400	4400
	40								1800	1900	2900	4000
50									1900	2800	3300	
63										2300	2800	
Selectivity limit (A)												
iC60N/H/L Curve C	0.5	T	T	T	T	T	T	T	T	T	T	T
	1	T	T	T	T	T	T	T	T	T	T	T
	2	1200	T	T	T	T	T	T	T	T	T	T
	3	21	3400	3400	T	T	T	T	T	T	T	T
	4	18	1200	1300	5800	5600	T	T	T	T	T	T
	6	15	700	720	1900	1900	6000	11000	T	T	T	T
	10		22	480	1200	1200	2200	4200	10000	T	T	T
	13			28	51	900	1800	3000	7300	8000	T	T
	16				35	740	1300	2200	4700	5400	T	T
	20					46	88	1700	3500	3500	6900	T
	25						56	600	2500	2500	4600	6800
	32							80	2000	2200	3400	4400
	40								756	1900	2900	3500
50									960	2300	2800	
63										2300	2800	
Selectivity limit (A)												
iC60N/H/L Curve D	0.5	T	T	T	T	T	T	T	T	T	T	T
	1	T	T	T	T	T	T	T	T	T	T	T
	2	1200	T	T	T	T	T	T	T	T	T	T
	3	21	3000	3400	T	T	T	T	T	T	T	T
	4	18	1100	1300	5800	4500	T	T	T	T	T	T
	6	15	600	600	1600	1600	5300	11000	T	T	T	T
	10		22	420	1000	1100	2200	3400	10000	T	T	T
	13			28	51	900	1700	2600	6400	7100	T	T
	16				35	380	1300	2200	3900	4500	T	T
	20					46	480	1500	3000	3500	6000	T
	25						56	600	2100	2500	4100	5900
	32							80	1800	2200	3400	4400
	40								756	1700	2400	2900
50									960	2300	2800	
63										2000	2300	

4000 Selectivity limit = 4 kA.

T Total selectivity.

No selectivity.

**Note:** the selectivity limits given in the table must be compared to the phase/neutral fault current (Ik1).

If the max. phase/earth fault current (If) is high, the selectivity of this fault current should also be verified by referring to the limits given in the dark green part of the table.

# Selectivity table

Upstream: NG125N/H/L, C120N/H curve B

Downstream: iC60 RCBO curves B, C

## 220-240/380-415 V AC



Upstream	NG125N/H/L, C120N/H											
	Curve B											
In (A)	10	16	20	25	32	40	50	63	80	100	125	

Downstream		3P/4P 380-415 V AC											
Selectivity limit (A)													
iC60 RCBO Curve B	6	15	64	80	100	130	290	300	440	620	930	1700	
	10		22	80	100	130	200	200	380	550	770	1300	
	13			28	100	130	160	200	380	480	680	1100	
	16				35	130	160	200	250	320	600	940	
	20					46	160	200	250	320	400	850	
	25						56	200	250	320	400	750	
	32							80	250	320	400	500	
Selectivity limit (A)													
iC60 RCBO Curve C	6			80	100	130	290	300	440	620	930	1700	
	10					130	160	200	380	550	770	1100	
	13						160	200	250	480	680	940	
	16							200	250	320	600	940	
	20									320	400	850	
	25									320	400	750	
	32											500	

4000 Selectivity limit = 4 kA.

No selectivity.

Note: if you cannot find your combination, refer to the selection table on page A-12

# Selectivity table

Upstream: NG125N/H/L, C120N/H curve B

Downstream: iC60 RCBO curves B, C

A

## 220-240/380-415 V AC

Upstream	NG125N/H/L, C120N/H										
	Curve B										
In (A)	10	16	20	25	32	40	50	63	80	100	125

Downstream		2P (220-240 V AC Phase to Neutral) 3P (220-240 V AC Phase to Phase)										
Selectivity limit (A)												
<b>iC60 RCBO</b> Curve B	6	15	64	80	150	150	350	430	810	1400	2100	6100
	10		22	80	100	130	160	200	500	840	1300	2500
	13			28	100	130	240	200	440	770	1100	1900
	16				35	130	160	200	380	520	770	1400
	20					46	160	200	250	320	600	1000
	25						56	200	250	320	400	890
	32						80	250	320	400	840	
Selectivity limit (A)												
<b>iC60 RCBO</b> Curve C	6			80	150	150	350	430	810	1400	2100	6100
	10					130	160	200	500	840	1300	2500
	13						160	200	440	620	1100	1900
	16							200	380	520	770	1400
	20									320	600	1000
	25									320	400	890
	32										840	

4000 Selectivity limit = 4 kA.

No selectivity.

**Note:** the selectivity limits given in the table must be compared to the phase/neutral fault current (Ik1).

If the max. phase/earth fault current (If) is high, the selectivity of this fault current should also be verified by referring to the limits given in the dark green part of the table.

# Selectivity table

Upstream: NG125N/H/L, C120N/H curve C

Downstream: iC60 RCBO curves B, C

## 220-240/380-415 V AC



Upstream		NG125N/H/L										
		Curve C										
In (A)		10	16	20	25	32	40	50	63	80	100	125

**Downstream 3P/4P 380-415 V AC**

Selectivity limit (A)												
<b>iC60 RCBO</b> Curve B	<b>6</b>	15	130	160	200	610	650	1400	2300	2300	3600	6400
	<b>10</b>		22	160	200	500	510	1100	1300	1600	2200	3600
	<b>13</b>			28	200	460	470	930	1100	1400	2000	2600
	<b>16</b>				35	380	430	770	950	1200	1700	2300
	<b>20</b>					46	320	680	850	960	1500	2100
	<b>25</b>						56	600	760	960	1200	1800
	<b>32</b>							80	500	640	1200	1500
Selectivity limit (A)												
<b>iC60 RCBO</b> Curve C	<b>6</b>	15	130	160	200	610	650	1400	2300	2300	3600	5500
	<b>10</b>		22	160	200	500	510	930	1300	1400	2200	3100
	<b>13</b>			28	51	420	430	770	1100	1200	2000	2600
	<b>16</b>				35	256	400	770	950	1200	1700	2300
	<b>20</b>					46	320	680	850	960	1500	1800
	<b>25</b>						56	400	760	960	1200	1800
	<b>32</b>							80	500	640	1200	1500

4000 Selectivity limit = 4 kA.

No selectivity.

**Note:** if you cannot find your combination, refer to the selection table on page A-12

# Selectivity table

Upstream: NG125N/H/L, C120N/H curve C

Downstream: iC60 RCBO curves B, C

## 220-240/380-415 V AC

Upstream		NG125N/H/L										
		Curve C										
In (A)		10	16	20	25	32	40	50	63	80	100	125
<b>Downstream</b>		<b>2P (220-240 V AC Phase to Neutral)</b>										
		<b>3P (220-240 V AC Phase to Phase)</b>										
<b>Selectivity limit (A)</b>												
<b>iC60 RCBO</b>	<b>6</b>	15	190	330	510	1500	2700	7200	9000	9000	T	T
Curve B	<b>10</b>		22	160	300	1000	1400	2700	3500	3500	7400	T
	<b>13</b>			28	200	760	910	2000	2700	2700	4900	8100
	<b>16</b>				35	620	620	1600	2700	2700	3600	5500
	<b>20</b>					46	480	1100	1600	1600	2200	3600
	<b>25</b>						56	930	1200	1200	2000	2600
	<b>32</b>							80	930	960	1700	2300
<b>Selectivity limit (A)</b>												
<b>iC60 RCBO</b>	<b>6</b>	15	190	290	510	1500	2700	7200	9000	9000	T	T
Curve C	<b>10</b>		22	160	200	890	1200	2700	3700	3700	6600	T
	<b>13</b>			28	51	760	770	2000	2700	2700	4000	7200
	<b>16</b>				35	256	620	1600	2700	2700	3600	4600
	<b>20</b>					46	320	1100	1400	1400	2200	3600
	<b>25</b>						56	400	1100	1200	2000	2600
	<b>32</b>							80	500	960	1400	2300

4000 Selectivity limit = 4 kA.

T Total selectivity.

No selectivity.

**Note:** the selectivity limits given in the table must be compared to the phase/neutral fault current ( $I_{k1}$ ).

If the max. phase/earth fault current ( $I_f$ ) is high, the selectivity of this fault current should also be verified by referring to the limits given in the dark green part of the table.



# Selectivity table

Upstream: NG125N/H/L, C120N/H curve D

Downstream: iC60 RCBO curves B, C

## 220-240/380-415 V AC



Upstream	NG125N/H/L, C120N/H											
	Curve D											
In (A)	10	16	20	25	32	40	50	63	80	100	125	

Downstream 3P/4P 380-415 V AC												
Selectivity limit (A)												
iC60 RCBO Curve B	6	15	340	360	730	740	1300	2600	4700	6200	T	T
	10		22	240	590	660	910	1700	2600	3500	T	T
	13			28	300	580	810	1500	2100	2500	4600	T
	16				35	380	720	1300	1900	2400	3600	T
	20					46	480	1100	1600	2000	3000	3600
	25						56	900	1400	1700	2400	2900
	32							83	1100	1700	2400	2600
Selectivity limit (A)												
iC60 RCBO Curve C	6	15	340	360	730	740	1300	2200	4700	6200	T	T
	10		22	240	590	580	910	1700	2600	3500	T	T
	13			28	51	580	720	1300	2100	2500	4100	T
	16				35	380	480	1100	1900	2400	3600	T
	20					46	88	1100	1600	2000	2700	2900
	25						56	600	1400	1700	2400	2900
	32							80	1100	1400	2400	2600

4000 Selectivity limit = 4 kA.

T Total selectivity.

No selectivity.

Note: if you cannot find your combination, refer to the selection table on page A-12

# Selectivity table

Upstream: NG125N/H/L, C120N/H curve D

Downstream: iC60 RCBO curves B, C

## 220-240/380-415 V AC

Upstream		NG125N/H/L, C120N/H										
		Curve D										
In (A)		10	16	20	25	32	40	50	63	80	100	125
<b>Downstream</b>		<b>2P (220-240 V AC Phase to Neutral)</b>										
		<b>3P (220-240 V AC Phase to Phase)</b>										
<b>Selectivity limit (A)</b>												
<b>iC60 RCBO</b>	<b>6</b>	15	700	720	1900	1900	6000	11000	T	T	T	T
Curve B	<b>10</b>		22	540	1200	1200	2600	4200	10000	T	T	T
	<b>13</b>			28	300	900	1800	3400	7300	8000	T	T
	<b>16</b>				35	740	1500	2200	4700	5400	T	T
	<b>20</b>					46	910	1700	3500	3500	6900	T
	<b>25</b>						56	1500	2500	2500	5200	6800
	<b>32</b>							83	2000	2400	3400	4400
<b>Selectivity limit (A)</b>												
<b>iC60 RCBO</b>	<b>6</b>	15	700	720	1900	1900	6000	11000	T	T	T	T
Curve C	<b>10</b>		22	480	1200	1200	2200	4200	10000	T	T	T
	<b>13</b>			28	51	900	1800	3000	7300	8000	T	T
	<b>16</b>				35	740	1300	2200	4700	5400	T	T
	<b>20</b>					46	88	1700	3500	3500	6900	T
	<b>25</b>						56	600	2500	2500	4600	6800
	<b>32</b>							80	2000	2200	3400	4400

4000	Selectivity limit = 4 kA.
------	---------------------------

T	Total selectivity.
---	--------------------

	No selectivity.
--	-----------------

**Note:** the selectivity limits given in the table must be compared to the phase/neutral fault current ( $I_{k1}$ ).

If the max. phase/earth fault current ( $I_f$ ) is high, the selectivity of this fault current should also be verified by referring to the limits given in the dark green part of the table.

# Selectivity table

Upstream: NG125N/H/L, C120N/H curve B

Downstream: C120, NG125 curves B, C, D

## 220-240/380-415 V AC



Upstream		NG125N/H/L, C120N/H										
		Curve B										
In (A)		10	16	20	25	32	40	50	63	80	100	125
<b>Downstream</b>		<b>1P, 1P+N, 2P (380-415 V)</b>										
		<b>two-phase network</b>										
		<b>3P, 3P+N, 4P</b>										
<b>Selectivity limit (A)</b>												
<b>C120, NG125</b> Curve B	10			80	100	130	160	200	250	320	400	800
	16				100	130	160	200	250	320	400	750
	20					65	160	200	250	320	400	750
	25						160	200	250	320	400	500
	32							200	250	320	400	500
	40								250	320	400	500
	50									320	400	500
	63										400	500
	80										400	500
<b>Selectivity limit (A)</b>												
<b>C120, NG125</b> Curve C	10					130	160	200	250	320	400	750
	16							200	250	320	400	500
	20								250	320	400	500
	25									320	400	500
	32										400	500
	40										400	500
<b>Selectivity limit (A)</b>												
<b>C120, NG125</b> Curve D	10							200	250	320	400	750
	16									320	400	500
	20										400	500
	25											500

Selectivity limit = 4 kA.

No selectivity.

**Note:** if you cannot find your combination, refer to the selection table on page A-12

# Selectivity table

Upstream : NG125N/H/L, C120N/H curve B

Downstream: C120, NG125 curves B, C, D

## 220-240/380-415 V AC

Upstream		NG125N/H/L, C120N/H										
		Curve B										
In (A)		10	16	20	25	32	40	50	63	80	100	125
<b>Downstream</b>		<b>2P (220-240 V)</b>										
		<b>single-phase network</b>										
<b>Selectivity limit (A)</b>												
<b>C120, NG125 Curve B</b>	10			80	100	130	260	200	400	540	670	1100
	16				100	130	240	200	250	480	630	910
	20					65	160	200	250	320	600	830
	25						160	200	250	320	400	830
	32							200	250	320	400	750
	40								250	320	400	750
	50									320	400	500
	63										400	500
80											400	
<b>Selectivity limit (A)</b>												
<b>C120, NG125 Curve C</b>	10					130	240	200	250	480	670	980
	16							200	250	320	400	830
	20								250	320	400	830
	25									320	400	750
	32										400	500
40											500	
<b>Selectivity limit (A)</b>												
<b>C120, NG125 Curve D</b>	10							200	250	320	630	980
	16									320	400	750
	20										400	750
	25											500

4000	Selectivity limit = 4 kA.
------	---------------------------

	No selectivity.
--	-----------------

**Note:** the selectivity limits given in the table must be compared to the phase/neutral fault current ( $I_{k1}$ ).

If the max. phase/earth fault current ( $I_f$ ) is high, the selectivity of this fault current should also be verified by referring to the limits given in the dark green part of the table.

# Selectivity table

Upstream: NG125N/H/L, C120N/H curve C

Downstream: C120, NG125 curves B, C, D

## 220-240/380-415 V AC



Upstream		NG125N/H/L, C120N/H										
		Curve C										
In (A)		10	16	20	25	32	40	50	63	80	100	125
<b>Downstream</b>		<b>1P, 1P+N, 2P (380-415 V)</b>										
		<b>two-phase network</b>										
		<b>3P, 3P+N, 4P</b>										
<b>Selectivity limit (A)</b>												
<b>C120, NG125</b> Curve B	10											
	16		130	160	200	260	320	650	820	960	1300	1700
	20				200	260	320	600	760	800	900	1500
	25					65	320	400	500	640	800	1500
	32						320	400	500	640	800	1000
	40							400	500	640	800	1000
	50								500	640	800	1000
	63									640	800	1000
	80										800	1000
<b>Selectivity limit (A)</b>												
<b>C120, NG125</b> Curve C	10											
	16		39	160	200	260	320	650	760	900	1200	1700
	20				70	110	320	400	500	640	800	1500
	25					65	124	400	500	640	800	1000
	32						89	149	500	640	800	1000
	40							123	240	640	800	1000
	50								181	269	800	1000
	63									227	800	1000
	80										800	1000
<b>Selectivity limit (A)</b>												
<b>C120, NG125</b> Curve D	10					260	320	600	760	900	1200	1600
	16						320	400	500	640	800	1000
	20							400	500	640	800	1000
	25								500	640	800	1000
	40										800	1000

4000 Selectivity limit = 4 kA.

No selectivity.

**Note:** if you cannot find your combination, refer to the selection table on page A-12

# Selectivity table

Upstream: NG125N/H/L, C120N/H curve C

Downstream: C120, NG125 curves B, C, D



## 220-240/380-415 V AC

Upstream		NG125N/H/L, C120N/H										
		Curve C										
In (A)		10	16	20	25	32	40	50	63	80	100	125
<b>Downstream</b>		<b>2P (220-240 V) single-phase network</b>										
<b>Selectivity limit (A)</b>												
<b>C120, NG125</b> Curve B	10		130	160	200	480	510	930	1100	1200	1700	2500
	16				200	260	320	800	990	1100	1400	2000
	20					65	320	730	910	1100	1400	1900
	25						320	730	830	960	1200	1600
	32							400	830	960	1200	1600
	40								500	640	800	1500
	50									640	800	1500
	63										800	1000
80											1000	
<b>Selectivity limit (A)</b>												
<b>C120, NG125</b> Curve C	10		39	160	200	260	480	870	1100	1200	1700	2500
	16				70	110	320	730	910	1100	1400	2000
	20					65	124	670	830	960	1300	1700
	25						89	149	500	640	1200	1600
	32							123	240	640	800	1500
	40								181	269	800	1000
	50									227	800	1000
	63										800	1000
80											1000	
<b>Selectivity limit (A)</b>												
<b>C120, NG125</b> Curve D	10					260	320	800	1100	1100	1600	2200
	16						320	630	830	960	1300	1900
	20							400	760	960	1300	1700
	25								500	640	800	1500
	32										800	1500
40											1000	

4000 Selectivity limit = 4 kA.

No selectivity.

**Note:** the selectivity limits given in the table must be compared to the phase/neutral fault current (Ik1).

If the max. phase/earth fault current (If) is high, the selectivity of this fault current should also be verified by referring to the limits given in the dark green part of the table.

# Selectivity table

Upstream: NG125N/H/L, C120N/H curve D

Downstream: C120, NG125 curves B, C, D

## 220-240/380-415 V AC



Upstream		NG125N/H/L, C120N/H										
		Curve D										
In (A)		10	16	20	25	32	40	50	63	80	100	125
<b>Downstream</b>		<b>1P, 1P+N, 2P (380-415 V)</b>										
		<b>two-phase network</b>										
		<b>3P, 3P+N, 4P</b>										
<b>Selectivity limit (A)</b>												
<b>C120, NG125</b> Curve B	10		190	240	300	380	480	970	1300	1600	2200	2500
	16				300	380	480	600	1100	1400	2000	2300
	20					65	480	600	1100	1400	2000	2300
	25						480	600	760	960	1200	1500
	32							600	760	960	1200	1500
	40								760	960	1200	1500
	50									960	1200	1500
	63										1200	1500
80											1200	1500
<b>Selectivity limit (A)</b>												
<b>C120, NG125</b> Curve C	10		190	240	300	380	480	970	1300	1600	2200	2500
	16				70	110	480	600	1100	1400	2000	2300
	20					65	124	600	1100	1400	2000	2300
	25						89	149	760	960	1200	1500
	32							123	240	960	1200	1500
	40								181	269	1200	1500
	50									227	1200	1500
	63										1200	1500
80											1200	1500
<b>Selectivity limit (A)</b>												
<b>C120, NG125</b> Curve D	10		39	240	300	380	480	970	1300	1600	2200	2500
	16				70	110	480	600	1100	1400	2000	2300
	20					65	124	193	1100	1400	2000	2300
	25						89	149	236	960	1200	1500
	32							123	240	960	1200	1500
	40								181	269	1200	1500
	50									227	1200	1500
	63										1200	1500
80											1200	1500

Selectivity limit = 4 kA.

No selectivity.

**Note:** if you cannot find your combination, refer to the selection table on page A-12

# Selectivity table

Upstream: NG125N/H/L, C120N/H curve D

Downstream: C120, NG125 curves B, C, D



## 220-240/380-415 V AC

Upstream	NG125N/H/L, C120N/H											
	Curve D											
In (A)	10	16	20	25	32	40	50	63	80	100	125	

Downstream		2P (220-240 V) single-phase network											
<b>Selectivity limit (A)</b>													
C120, NG125 Curve B	10		190	240	250	380	720	1300	2000	2400	3700	4800	
	16				300	380	480	1100	1600	1900	2600	3200	
	20					65	480	1100	1500	1800	2600	2900	
	25						480	600	1200	1400	2100	2400	
	32							600	1200	1400	2100	2400	
	40								760	960	1200	1500	
	50									960	1200	1500	
	63										1200	1500	
	80											1500	
<b>Selectivity limit (A)</b>													
C120, NG125 Curve C	10		190	240	250	380	720	1300	2000	2400	3700	4800	
	16				70	110	480	1100	1600	1900	2600	3200	
	20					65	124	1100	1500	1800	2600	2900	
	25						89	149	1200	1400	2100	2400	
	32							123	240	1400	2100	2400	
	40								181	269	1200	1500	
	50									227	1200	1500	
	63										1200	1500	
	80											1500	
<b>Selectivity limit (A)</b>													
C120, NG125 Curve D	10		39	240	250	380	720	1300	2000	2400	3700	4800	
	16				70	110	480	1100	1600	1900	2600	3200	
	20					65	124	193	1500	1800	2600	2900	
	25						89	149	236	1400	2100	2400	
	32							123	240	1400	2100	2400	
	40								181	269	1200	1500	
	50									227	1200	1500	
	63										1200	1500	
	80											1500	

4000 Selectivity limit = 4 kA.

No selectivity.

**Note:** the selectivity limits given in the table must be compared to the phase/neutral fault current (Ik1).

If the max. phase/earth fault current (If) is high, the selectivity of this fault current should also be verified by referring to the limits given in the dark green part of the table.



# Selectivity table

## Selectivity of circuit breakers

U<sub>e</sub> ≤ 440 V AC

### Contents

Downstream Type	Upstream									
	NSXm		NSX100		NSX160		NSX250		NSX400	NSX630
	TM-D	Micrologic	TM-D	Micrologic	TM-D	Micrologic	TM-D	Micrologic	Micrologic	Micrologic
iDPN / iC40	page A-71	page A-72	page A-73	page A-74	page A-73	page A-74	page A-73	page A-74	page A-77	page A-77
iDPN N, iC40 N	page A-71	page A-72	page A-73	page A-74	page A-73	page A-74	page A-73	page A-74	page A-77	page A-77
iC60N/H/L	page A-71	page A-72	page A-73	page A-74	page A-73	page A-74	page A-73	page A-74	page A-77	page A-77
C120, NG125	page A-71	page A-72	page A-73	page A-74	page A-73	page A-74	page A-73	page A-74	page A-77	page A-77
Compact NSXm	-	-	page A-73	page A-74	page A-73	page A-74	page A-73	page A-74	page A-77	page A-77
Compact NSX100	-	-	page A-75	page A-76	page A-75	page A-76	page A-75	page A-76	page A-77	page A-77
Compact NSX160	-	-	page A-75	page A-76	page A-75	page A-76	page A-75	page A-76	page A-77	page A-77
Compact NSX250	-	-	page A-75	page A-76	page A-75	page A-76	page A-75	page A-76	page A-77	page A-77
Compact NSX400	-	-	-	-	-	-	-	-	page A-77	page A-77

### Selectivity between circuit breakers

In the following tables we show the level of selectivity between two LV circuits that are protected by circuit breakers up to 440 V, 50/60 Hz systems.

This selectivity will be either:

- total: represented by a **T** (up to the breaking capacity of the downstream device),
- partial: selectivity limit current (I<sub>s</sub>) indicated. Below this value selectivity is ensured, above this value the upstream device is also involved in breaking,
- zero: no selectivity ensured.

# TOOLS

A

## Ecodial

Ecodial software is dedicated to LV electrical installation calculation in accordance with the IEC60364 international standard or national standards.

This 4<sup>th</sup> generation, "Ecodial Advance Calculation 4", offers a new ergonomic and new features:

- operating mode that allows easy calculation in case of installation with different type of sources (parallel transformers, back-up generators...)
- selectivity analysis associating curves checking and selectivity tables
- direct access to protection settings including residual current protections
- easy selection of alternate solutions or manual selection of a product.

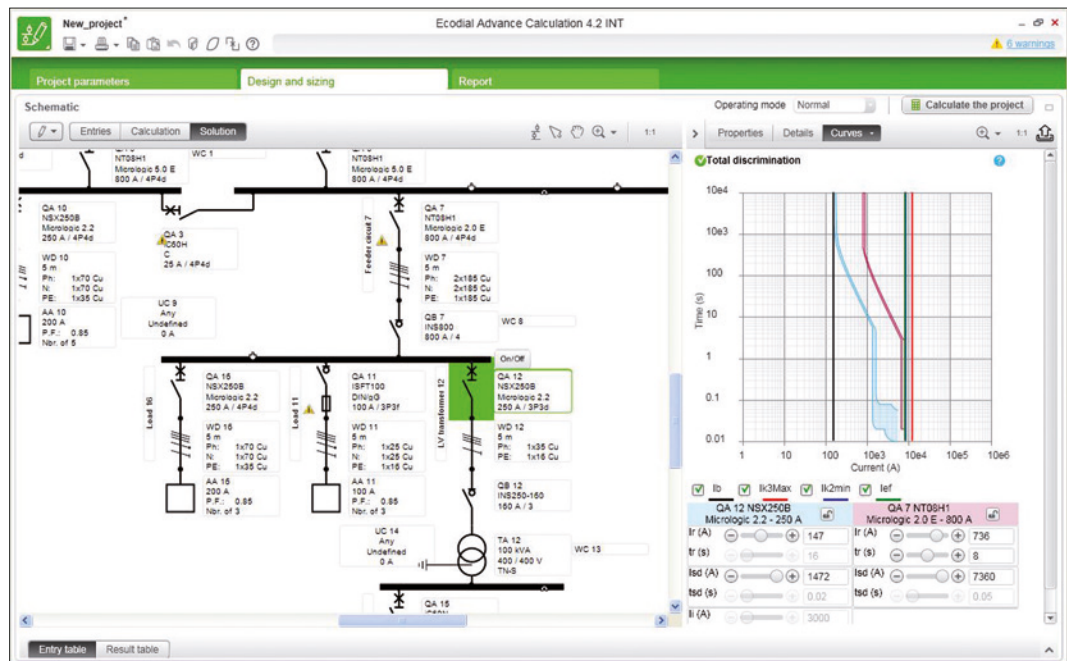

# Selectivity table

Upstream: Compact NSXm E/B/F/N/H TM-D

Downstream: iDPN, iC40, iC60, C120, NG125

U<sub>e</sub> ≤ 440 V AC <sup>[1]</sup>



Upstream		NSXm63 E/B/F/N/H						NSXm160 E/B/F/N/H/TM-D			
Trip unit		TM-D						TM-D			
Downstream		16	25	32	40	50	63	80	100	125	160
Rating	Setting I <sub>r</sub>	16	25	32	40	50	63	80	100	125	160
<b>Selectivity limit (kA)</b>											
iDPN	≤ 10	0.5	0.5	0.5	0.5	0.6	0.8	T	T	T	T
iDPN N	16			0.5	0.5	0.6	0.8	T	T	T	T
iDPN N Vigi	20				0.6	0.6	0.8	T	T	T	T
iDPN H Vigi	25					0.6	0.8	T	T	T	T
All curves	32						0.8	3	T	T	T
	40							2	T	T	T
iC40	≤ 10	0.5	0.5	0.5	0.5	0.6	0.8	T	T	T	T
iC40 N	13-16			0.5	0.5	0.6	0.8	T	T	T	T
iCV40	20				0.6	0.6	0.8	T	T	T	T
iCV40 N	25					0.6	0.8	T	T	T	T
All curves	32						0.8	3	T	T	T
	40							2	T	T	T
iC40	≤ 10	0.5	0.5	0.5	0.5	0.6	0.8	T	T	T	T
iC40 N	13-16			0.5	0.5	0.6	0.8	T	T	T	T
iCV40	20				0.6	0.6	0.8	T	T	T	T
iCV40 N	25					0.6	0.8	T	T	T	T
All curves	32						0.8	3	T	T	T
iC60N/H	≤ 10	0.5	0.5	0.5	0.5	0.6	0.8	T	T	T	T
Curves B, C, D	13-16			0.5	0.5	0.6	0.8	T	T	T	T
	20				0.5	0.6	0.8	T	T	T	T
	25					0.6	0.8	10	T	T	T
	32						0.8	3	T	T	T
	40							2	T	T	T
	50								6	8	8
	63									8	8
iC60L	≤ 10	0.5	0.5	0.5	0.5	0.6	0.8	T	T	T	T
Curves B, C, D, K, Z	13-16			0.5	0.5	0.6	0.8	T	T	T	T
	20				0.5	0.6	0.8	T	T	T	T
	25					0.6	0.8	10	T	T	T
	32						0.8	3	T	T	T
	40							2	16	16	16
	50								6	8	8
	63									8	8
iC60 RCBO	≤ 10	0.5	0.5	0.5	0.5	0.6	0.8	T	T	T	T
Curves B, C	13-16			0.5	0.5	0.6	0.8	T	T	T	T
	20				0.6	0.6	0.8	T	T	T	T
	25					0.6	0.8	T	T	T	T
	32						0.8	3	T	T	T
C120N/H	63									1.25	1.25
Curves B, C, D	80										1.25
	100										1.25
	125										
NG125N/H/L	≤20				0.6	0.6	0.8	0.8	1	1.25	1.25
Curves B, C, D	25						0.8	0.8	1	1.25	1.25
	32						0.8	0.8	1	1.25	1.25
	40							0.8	1	1.25	1.25
	50							0.8	1	1.25	1.25
	63									1.25	1.25
	80										1.25
	100 (N)										1.25
	125 (N)										

4 Selectivity limit = 4 kA.

T Total selectivity, up to the breaking capacity of the downstream circuit breaker.

No selectivity.

Note: respect the basic rules of selectivity, in terms of overload, short-circuit, ground fault and earth leakage when applicable see page A-2, or check curves with Schneider Electric online "Electrical calculation tools".

[1] 220V-240V for iDPN vigi & iC60 RCBO.

# Selectivity table

Upstream: Compact NSXm E/B/F/N/H Micrologic 4.1

Downstream: iDPN, iC40, iC60, C120, NG125

A

U<sub>e</sub> ≤ 440 V AC <sup>[1]</sup>

Upstream	NSXm E/B/F/N/H
Trip unit	Micrologic 4.1

Downstream		25		50			100			160	
Rating		16	25	32	40	50	63	80	100	125	160
Setting I <sub>r</sub> :		16	25	32	40	50	63	80	100	125	160
Selectivity limit (kA)											
iDPN	≤ 10	0.37	0.37	0.75	0.75	0.75	T	T	T	T	T
iDPN N	13-16		0.37	0.75	0.75	0.75	T	T	T	T	T
iDPN N Vigi	20				0.75	0.75	T	T	T	T	T
iDPN H Vigi	25					0.75	T	T	T	T	T
All curves	32						T	T	T	T	T
	40							T	T	T	T
iC40	≤ 10	0.37	0.37	0.75	0.75	0.75	T	T	T	T	T
iC40 N	13-16		0.37	0.75	0.75	0.75	T	T	T	T	T
iCV40	20				0.75	0.75	T	T	T	T	T
iCV40 N	25					0.75	T	T	T	T	T
All curves	32						T	T	T	T	T
	40							T	T	T	T
iCV40 H	≤ 10	0.37	0.37	0.75	0.75	0.75	T	T	T	T	T
All curves	13-16		0.37	0.75	0.75	0.75	T	T	T	T	T
	20				0.75	0.75	T	T	T	T	T
	25					0.75	T	T	T	T	T
	32						T	T	T	T	T
iC60 N/H	≤ 10	0.37	0.37	1.5	1.5	1.5	T	T	T	T	T
Curves B-C-D	13-16		0.37	0.75	0.75	0.75	T	T	T	T	T
	20				0.75	0.75	T	T	T	T	T
	25					0.75	T	T	T	T	T
	32						T	T	T	T	T
	40							T	T	T	T
	50								8	8	8
	63									8	8
iC60 L	≤ 10	0.37	0.37	1.5	1.5	1.5	T	T	T	T	T
Curves B-C-D-K-Z	13-16		0.37	0.75	0.75	0.75	T	T	T	T	T
	20				0.75	0.75	T	T	T	T	T
	25					0.75	T	T	T	T	T
	32						T	T	T	T	T
	40							16	16	16	16
	50								8	8	8
	63									8	8
iC60 RCBO	≤ 10	0.37	0.37	0.75	0.75	0.75	T	T	T	T	T
Curves B, C	13-16		0.37	0.75	0.75	0.75	T	T	T	T	T
	20				0.75	0.75	T	T	T	T	T
	25					0.75	T	T	T	T	T
	32						T	T	T	T	T
C120 N/H	63									2.4	2.4
Curves B-C-D	80										2.4
	100										2.4
	125										
NG125 N/H/L	≤ 20				0.75	0.75	1.5	1.5	1.5	2.4	2.4
Curves B-C-D	25					0.75	1.5	1.5	1.5	2.4	2.4
	32						1.5	1.5	1.5	2.4	2.4
	40							1.5	1.5	2.4	2.4
	50							1.5	1.5	2.4	2.4
	63								2.4	2.4	2.4
	80									2.4	2.4
	100 (N)										2.4
	125 (N)										

- 4 Selectivity limit = 4 kA.
- T Total selectivity, up to the breaking capacity of the downstream circuit breaker.
- No selectivity.

**Note:** respect the basic rules of selectivity, in terms of overload, short-circuit, ground fault and earth leakage when applicable see page A-2, or check curves with Schneider Electric online "Electrical calculation tools".

[1] 220V-240V for iDPN vigi & iC60 RCBO.

# Selectivity table

Upstream: Compact NSX100-250 TM-D

Downstream: iDPN, iC40, iC60, C120, NG125, Compact NSXm

U<sub>e</sub> ≤ 440 V AC [1]

Upstream		NSX100B/F/N/H/S/L/R							NSX160B/F/N/H/S/L					NSX250B/F/N/H/S/L/R				
Trip unit		TM-D							TM-D					TM-D				
Downstream		16	25	32	40	50	63	80	100	80	100	125	160	160	200	250		
Rating		16	25	32	40	50	63	80	100	80	100	125	160	160	200	250		
Setting Ir:		16	25	32	40	50	63	80	100	80	100	125	160	160	200	250		
Selectivity limit (kA)																		
iDPN	≤ 10	0.19	0.3	0.4	0.5	0.5	0.5	0.63	0.8	0.63	0.8	T	T	T	T	T		
	iDPN N		0.3	0.4	0.5	0.5	0.5	0.63	0.8	0.63	0.8	T	T	T	T	T		
	iDPN N Vigi			0.4	0.5	0.5	0.5	0.63	0.8	0.63	0.8	T	T	T	T	T		
	iDPN H Vigi					0.5	0.5	0.63	0.8	0.63	0.8	T	T	T	T	T		
	All curves						0.5	0.63	0.8	0.63	0.8	T	T	T	T	T		
	40						0.5	0.63	0.8	0.63	0.8	T	T	T	T	T		
iC40	≤ 10	0.19	0.3	0.4	0.5	0.5	0.5	0.63	0.8	0.63	0.8	T	T	T	T	T		
	iC40 N		0.3	0.4	0.5	0.5	0.5	0.63	0.8	0.63	0.8	T	T	T	T	T		
	iCV40			0.4	0.5	0.5	0.5	0.63	0.8	0.63	0.8	T	T	T	T	T		
	iCV40 N					0.5	0.5	0.63	0.8	0.63	0.8	T	T	T	T	T		
	iCV40 H (≤32)						0.5	0.63	0.8	0.63	0.8	T	T	T	T	T		
	40						0.5	0.63	0.8	0.63	0.8	T	T	T	T	T		
iC60N/H	≤ 10	0.19	0.3	0.4	0.5	0.5	0.5	1	2	1	2	T	T	T	T	T		
	Curves B, C, D		0.3	0.4	0.5	0.5	0.5	1	2	1	2	T	T	T	T	T		
	20			0.4	0.5	0.5	0.5	0.63	1.5	0.63	1.5	T	T	T	T	T		
	25				0.5	0.5	0.5	0.63	1.5	0.63	1.5	T	T	T	T	T		
	32						0.5	0.63	1	0.63	1	T	T	T	T	T		
	40						0.5	0.63	1	0.63	1	T	T	T	T	T		
	50							0.63	0.8	0.63	0.8	T	T	T	T	T		
	63							0.8	0.8	0.8	0.8	T	T	T	T	T		
iC60 L	≤ 10	0.19	0.3	0.4	0.5	0.5	0.5	1	2	1	2	T	T	T	T	T		
	Curves		0.3	0.4	0.5	0.5	0.5	1	2	1	2	T	T	T	T	T		
	B-C-D-K-Z			0.4	0.5	0.5	0.5	0.63	1.5	0.63	1.5	T	T	T	T	T		
	20				0.5	0.5	0.5	0.63	1.5	0.63	1.5	T	T	T	T	T		
	25						0.5	0.63	1	0.63	1	T	T	T	T	T		
	32							0.63	1	0.63	1	T	T	T	T	T		
	40							0.63	1	0.63	1	T	T	T	T	T		
	50							0.63	0.8	0.63	0.8	T	T	T	T	T		
	63								0.8	0.8	0.8	T	T	T	T	T		
iC60 RCBO	≤ 10		0.3	0.4	0.5	0.5	0.5	1	2	1	2	T	T	T	T	T		
	Curves B, C		0.3	0.4	0.5	0.5	0.5	1	2	1	2	T	T	T	T	T		
	20			0.4	0.5	0.5	0.5	0.63	1.5	0.63	1.5	T	T	T	T	T		
	25				0.5	0.5	0.5	0.63	1.5	0.63	1.5	T	T	T	T	T		
	32						0.5	0.63	1	0.63	1	T	T	T	T	T		
C120N/H	63								0.8		0.8	2.4	2.4	2.4	T	T		
	Curves B, C, D												2.4	2.4	T	T		
	80												2.4	2.4	T	T		
	100													2.4	T	T		
	125															T		
NG125N/H/L	≤ 20			0.4	0.5	0.5	0.5	0.63	0.8	0.63	0.8	T	T	T	T	T		
	Curves B, C, D						0.5	0.63	0.8	0.63	0.8	2.4	2.4	2.4	T	T		
	25							0.63	0.8	0.63	0.8	2.4	2.4	2.4	T	T		
	32						0.5	0.63	0.8	0.63	0.8	2.4	2.4	2.4	T	T		
	40							0.63	0.8	0.63	0.8	2.4	2.4	2.4	T	T		
	50								0.8	0.63	0.8	2.5	2.5	2.5	T	T		
	63										0.8	2.5	2.5	2.5	T	T		
	80												2.5	2.5	T	T		
	100 (N)															T	T	
125 (N)																T		
Compact NSXm	16			0.4	0.5	0.5	0.5	0.63	0.8	0.63	0.8	1.25	1.25	1.25	T	T		
	E/B/F/N/H				0.5	0.5	0.5	0.63	0.8	0.63	0.8	1.25	1.25	1.25	T	T		
	TM-D						0.5	0.63	0.8	0.63	0.8	1.25	1.25	1.25	T	T		
	32							0.63	0.8	0.63	0.8	1.25	1.25	1.25	T	T		
	40							0.63	0.8	0.63	0.8	1.25	1.25	1.25	T	T		
	50							0.63	0.8	0.63	0.8	1.25	1.25	1.25	T	T		
	63								0.8		0.8	1.25	1.25	1.25	T	T		
	80											1.25	1.25	1.25	T	T		
	100												1.25	1.25	T	T		
	125															T	T	
Compact NSXm	25				0.5	0.5	0.5	0.63	0.8	0.63	0.8	1.25	1.25	1.25	T	T		
	E/B/F/N/H							0.63	0.8	0.63	0.8	1.25	1.25	1.25	T	T		
	Micrologic 4.1												1.25	1.25	T	T		
	160															T		

4 Selectivity limit = 4 kA.

T Total selectivity, up to the breaking capacity of the downstream circuit breaker.

No selectivity.

Note: respect the basic rules of selectivity, in terms of overload, short-circuit, ground fault and earth leakage when applicable see page A-2, or check curves with Schneider Electric online "Electrical calculation tools".

[1] 220V-240V for iDPN vigi & iC60 RCBO.

# Selectivity table

Upstream: Compact NSX100-250 Micrologic

Downstream: iDPN, iC40, iC60, C120, NG125, Compact NSXm

$U_e \leq 440 \text{ V AC}^{[1]}$

A

Upstream		NSX100B/F/N/H/S/L/R								NSX160B/F/N/H/S/L				NSX250B/F/N/H/S/L/R		
Trip unit		Micrologic [2]								Micrologic [2]				Micrologic [2]		
Downstream	Rating (A)	40				100				160				250		
	Setting I <sub>r</sub>	16	25	32	40	40	63	80	100	80	100	125	160	160	200	250
Selectivity limit (kA)																
iDPN	≤ 10	T	T	T	T	T	T	T	T	T	T	T	T	T	T	T
	iDPN N		T	T	T	T	T	T	T	T	T	T	T	T	T	T
	iDPN N Vigi			T	T	T	T	T	T	T	T	T	T	T	T	T
	iDPN H Vigi				T	T	T	T	T	T	T	T	T	T	T	T
	All curves	32					T	T	T	T	T	T	T	T	T	T
	40						T	T	T	T	T	T	T	T	T	
iC40	≤ 10	T	T	T	T	T	T	T	T	T	T	T	T	T	T	T
	iC40 N		T	T	T	T	T	T	T	T	T	T	T	T	T	T
	iCV40			T	T	T	T	T	T	T	T	T	T	T	T	T
	iCV40 N				T	T	T	T	T	T	T	T	T	T	T	T
	iCV40 H (<=32)					T	T	T	T	T	T	T	T	T	T	T
All curves	40					T	T	T	T	T	T	T	T	T	T	
iC60N/H	≤ 10	T	T	T	T	T	T	T	T	T	T	T	T	T	T	T
	Curves B, C, D		T	T	T	T	T	T	T	T	T	T	T	T	T	T
		20		T	T	T	T	T	T	T	T	T	T	T	T	T
		25			T	T	T	T	T	T	T	T	T	T	T	T
		32				T	T	T	T	T	T	T	T	T	T	T
		40					T	T	T	T	T	T	T	T	T	T
		50						T	T	T	T	T	T	T	T	T
	63							6	6	T	T	T	T	T	T	
									6		T	T	T	T	T	
iC60 L	≤ 10	T	T	T	T	T	T	T	T	T	T	T	T	T	T	T
	Curves		T	T	T	T	T	T	T	T	T	T	T	T	T	T
	B-C-D-K-Z			T	T	T	T	T	T	T	T	T	T	T	T	T
		20			T	T	T	T	T	T	T	T	T	T	T	T
		25				T	T	T	T	T	T	T	T	T	T	T
		32					T	T	T	T	T	T	T	T	T	T
		40						T	T	T	T	T	T	T	T	T
	50							6	6	T	T	T	T	T	T	
	63								6		T	T	T	T	T	
iC60 RCBO	≤ 10	T	T	T	T	T	T	T	T	T	T	T	T	T	T	T
	Curves B, C		T	T	T	T	T	T	T	T	T	T	T	T	T	T
		20		T	T	T	T	T	T	T	T	T	T	T	T	T
		25			T	T	T	T	T	T	T	T	T	T	T	T
		32				T	T	T	T	T	T	T	T	T	T	T
C120N/H	63								1.5		2.4	2.4	2.4	T	T	T
	Curves B, C, D											2.4	2.4	T	T	T
		80											2.4	T	T	T
		100												2.4	T	T
		125													2.4	T
NG125N/H/L	≤ 20			0.6	0.6	1.5	1.5	1.5	1.5	T	T	T	T	T	T	T
	Curves B, C, D						1.5	1.5	1.5	2.4	2.4	2.4	2.4	T	T	T
		25					1.5	1.5	1.5	2.4	2.4	2.4	2.4	T	T	T
		32					1.5	1.5	1.5	2.4	2.4	2.4	2.4	T	T	T
		40					1.5	1.5	1.5	2.4	2.4	2.4	2.4	T	T	T
		50						1.5	1.5	2.4	2.4	2.4	2.4	T	T	T
		63							1.5		2.4	2.4	2.4	T	T	T
		80										2.4	2.4	T	T	T
		100 (N)											2.4	T	T	T
		125 (N)													T	T
Compact NSXm	16				0.6	1.5	1.5	1.5	1.5	2.4	2.4	2.4	2.4	T	T	T
	E/B/F/N/H					1.5	1.5	1.5	1.5	2.4	2.4	2.4	2.4	T	T	T
	TM-D						1.5	1.5	1.5	2.4	2.4	2.4	2.4	T	T	T
		40						1.5	1.5	2.4	2.4	2.4	2.4	T	T	T
		50							1.5	1.5	2.4	2.4	2.4	T	T	T
		63								1.5	2.4	2.4	2.4	T	T	T
		80										2.4	2.4	T	T	T
		100											2.4	T	T	T
		125													T	T
		160														T
Compact NSXm	25					1.5	1.5	1.5	1.5	2.4	2.4	2.4	2.4	T	T	T
	E/B/F/N/H						1.5	1.5	1.5	2.4	2.4	2.4	2.4	T	T	T
	Micrologic 4.1											2.4	2.4	T	T	T
		100											2.4	T	T	T
	160														T	

- 4 Selectivity limit = 4 kA.
- Total selectivity, up to the breaking capacity of the downstream circuit breaker.
- No selectivity.

**Note:** respect the basic rules of selectivity, in terms of overload, short-circuit, ground fault and earth leakage when applicable see page A-2, or check curves with Schneider Electric online "Electrical calculation tools".

**[1]** 220V-240V for iDPN vigi & iC60 RCBO

**[2]** Applicable for all "Distribution" Micrologic of Compact NSX range: 2.2 4.2, 5.2, 6.2, 7.2. For 4.2 and 7.2 selectivity rules for RCD apply in addition. Applicable for Generators and Service connection (G and AB type) Micrologic of Compact NSX range but curves shall be checked.

Not applicable for "Motor" Micrologic of Compact NSX range ("M" type).

# Selectivity table

Upstream: Compact NSX100-250 TM-D

Downstream: Compact NSX100-250 TM-D - Micrologic

U<sub>e</sub> ≤ 440 V AC



Upstream	NSX100B/F/N/H/S/L/R								NSX160B/F/N/H/S/L				NSX250B/F/N/H/S/L/R		
Trip unit	TM-D								TM-D				TM-D		
In (A)	16	25	32	40	50	63	80	100	80	100	125	160	160	200	250

Downstream																	
Selectivity limit (kA)																	
Compact NSX100 B/F TM-D	16				0.5	0.5	0.5	0.63	0.8	0.63	0.8	1.25	1.25	1.25	T	T	
	25					0.5	0.5	0.63	0.8	0.63	0.8	1.25	1.25	1.25	T	T	
	32						0.5	0.63	0.8	0.63	0.8	1.25	1.25	1.25	T	T	
	40							0.63	0.8	0.63	0.8	1.25	1.25	1.25	T	T	
	50								0.63	0.8	0.63	0.8	1.25	1.25	1.25	T	T
	63									0.8		0.8	1.25	1.25	1.25	T	T
	80												1.25	1.25	1.25	T	T
Compact NSX100 N/H/S/L/R TM-D	16				0.5	0.5	0.5	0.63	0.8	0.63	0.8	1.25	1.25	1.25	T	T	
	25					0.5	0.5	0.63	0.8	0.63	0.8	1.25	1.25	1.25	T	T	
	32						0.5	0.63	0.8	0.63	0.8	1.25	1.25	1.25	36	36	
	40							0.63	0.8	0.63	0.8	1.25	1.25	1.25	36	36	
	50								0.63	0.8	0.63	0.8	1.25	1.25	1.25	36	36
	63									0.8		0.8	1.25	1.25	1.25	36	36
	80												1.25	1.25	1.25	36	36
Compact NSX160 B/F/N/H/S/L TM-D	≤ 63												1.25	1.25	1.25	4	5
	80												1.25	1.25	1.25	4	5
	100													1.25	1.25	4	5
	160																5
Compact NSX250 B/F/N/H/S/L/R TM-D	≤ 100													1.25	2	2.5	
	125														2	2.5	
	160															2.5	
	200																
Compact NSX100 B/F/N/H/S/L/R Micrologic	40						0.5	0.63	0.8	0.63	0.8	1.25	1.25	1.25	2	2.5	
	100												1.25	1.25	2	2.5	
Compact NSX160 B/F/N/H/S/L Micrologic	40						0.5	0.63	0.8	0.63	0.8	1.25	1.25	1.25	2	2.5	
	100												1.25	1.25	2	2.5	
	160															2.5	
Compact NSX250 B/F/N/H/S/L/R Micrologic	≤ 100													1.25	2	2.5	
	160															2.5	
250																	

- 4 Selectivity limit = 4 kA.
- T Total selectivity, up to the breaking capacity of the downstream circuit breaker.
- No selectivity.

**Note:** respect the basic rules of selectivity, in terms of overload, short-circuit, ground fault and earth leakage when applicable see page A-2, or check curves with Schneider Electric online "Electrical calculation tools".

# Selectivity table

Upstream: Compact NSX100-250 Micrologic

Downstream: Compact NSX100-250 TM-D - Micrologic

Ue ≤ 440 V AC

A

Upstream		NSX100B/F/N/H/S/L/R								NSX160B/F/N/H/S/L				NSX250B/F/N/H/S/L/R		
Trip unit		Micrologic <sup>[1]</sup>								Micrologic <sup>[1]</sup>				Micrologic <sup>[1]</sup>		
Downstream	Rating (A)	40				100				160				250		
	Setting Ir	16	25	32	40	40	63	80	100	80	100	125	160	160	200	250
<b>Selectivity limit (kA)</b>																
Compact NSX100 16 B/F TM-D	16					1.5	1.5	1.5	1.5	2.4	2.4	2.4	2.4	T	T	T
	25					1.5	1.5	1.5	1.5	2.4	2.4	2.4	2.4	T	T	T
	32						1.5	1.5	1.5	2.4	2.4	2.4	2.4	T	T	T
	40							1.5	1.5	2.4	2.4	2.4	2.4	T	T	T
	50								1.5	2.4	2.4	2.4	2.4	T	T	T
	63										2.4	2.4	2.4	T	T	T
	80											2.4	2.4	T	T	T
	100												2.4	T	T	T
Compact NSX100 16 N/H/S/L/R TM-D	16					1.5	1.5	1.5	1.5	2.4	2.4	2.4	2.4	T	T	T
	25					1.5	1.5	1.5	1.5	2.4	2.4	2.4	2.4	T	T	T
	32						1.5	1.5	1.5	2.4	2.4	2.4	2.4	36	36	36
	40							1.5	1.5	2.4	2.4	2.4	2.4	36	36	36
	50								1.5	2.4	2.4	2.4	2.4	36	36	36
	63										2.4	2.4	2.4	36	36	36
	80											2.4	2.4	36	36	36
	100												2.4	36	36	36
Compact NSX160 ≤ 63 B/F/N/H/S/L TM-D	80										2.4	2.4	2.4	3	3	3
	100											2.4	2.4	3	3	3
	160												2.4	3	3	3
	160															3
Compact NSX250 ≤ 100 B/F/N/H/S/L/R TM-D	125													3	3	3
	160														3	3
	200															3
	200															
Compact NSX100 40 B/F Micrologic	100						1.5	1.5	1.5	2.4	2.4	2.4	2.4	T	T	T
	100												2.4	T	T	T
Compact NSX100 40 N/H/S/L/R Micrologic	100						1.5	1.5	1.5	2.4	2.4	2.4	2.4	36	36	36
	100												2.4	36	36	36
Compact NSX160 40 B/F/N/H/S/L Micrologic	100									2.4	2.4	2.4	2.4	3	3	3
	160												2.4	3	3	3
	160															3
Compact NSX250 ≤ 100 B/F/N/H/S/L/R Micrologic	160													3	3	3
	250															3

- 4 Selectivity limit = 4 kA.
- T Total selectivity, up to the breaking capacity of the downstream circuit breaker.
- No selectivity.

**Note:** respect the basic rules of selectivity, in terms of overload, short-circuit, ground fault and earth leakage when applicable see page A-2, or check curves with Schneider Electric online "Electrical calculation tools".  
<sup>[1]</sup> Applicable for all "Distribution" Micrologic of Compact NSX range: 2.2, 4.2, 5.2, 6.2, 7.2. For 4.2 and 7.2 selectivity rules for RCD apply in addition. Applicable for Generators and Service connection (G and AB type) Micrologic of Compact NSX range but curves shall be checked. Not applicable for "Motor" Micrologic of Compact NSX range ("M" type).



# Selectivity table

Upstream: Compact NSX400-630 Micrologic

Downstream: iDPN, iC40, iC60, C120, NG125, Compact NSXm, Compact NSX100-400

Ue ≤ 440 V AC



Upstream		NSX400F/N/H/S/L/R					NSX630F/N/H/S/L/R				
Trip unit		Micrologic [1]					Micrologic [1]				
Downstream	Rating (A)	400					630				
	Setting Ir	160	200	250	320	400	250	320	400	500	630
<b>Selectivity limit (kA)</b>											
iDPN, iDPN N		T	T	T	T	T	T	T	T	T	T
iC40, iC40N		T	T	T	T	T	T	T	T	T	T
iC60N/H/L		T	T	T	T	T	T	T	T	T	T
C120N/H	≤ 80	T	T	T	T	T	T	T	T	T	T
	100		T	T	T	T	T	T	T	T	T
	125			T	T	T	T	T	T	T	T
NG125N/H/L	≤ 80	T	T	T	T	T	T	T	T	T	T
	100		T	T	T	T	T	T	T	T	T
	125			T	T	T	T	T	T	T	T
Compact NSXm E/B/F/N/H TM-D	≤ 100	T	T	T	T	T	T	T	T	T	T
	125		T	T	T	T	T	T	T	T	T
	160			T	T	T	T	T	T	T	T
Compact NSXm E/B/F/N/H Micrologic 4.1	25	T	T	T	T	T	T	T	T	T	T
	50	T	T	T	T	T	T	T	T	T	T
	100	T	T	T	T	T	T	T	T	T	T
	160			T	T	T	T	T	T	T	T
Compact NSX100 B/F/N/H/S/L/R TM-D	≤ 80	T	T	T	T	T	T	T	T	T	T
	100	T	T	T	T	T	T	T	T	T	T
Compact NSX160 B/F/N/H/S/L TM-D	≤ 100	T	T	T	T	T	T	T	T	T	T
	125		T	T	T	T	T	T	T	T	T
	160			T	T	T	T	T	T	T	T
	250										
Compact NSX250 B/F/N/H/S/L/R TM-D	≤ 100	4.8	4.8	4.8	4.8	4.8	T	T	T	T	T
	125		4.8	4.8	4.8	4.8	T	T	T	T	T
	160			4.8	4.8	4.8	T	T	T	T	T
	200				4.8	4.8		T	T	T	T
	250					4.8			T	T	T
Compact NSX100 B/F/N/H/S/L/R Micrologic	40	T	T	T	T	T	T	T	T	T	T
	100	T	T	T	T	T	T	T	T	T	T
Compact NSX160 B/F/N/H/S/L Micrologic	40	T	T	T	T	T	T	T	T	T	T
	100	T	T	T	T	T	T	T	T	T	T
	160			T	T	T	T	T	T	T	T
Compact NSX250 B/F/N/H/S/L/R Micrologic	≤ 100	4.8	4.8	4.8	4.8	4.8	T	T	T	T	T
	160			4.8	4.8	4.8	T	T	T	T	T
	250					4.8			T	T	T
Compact NSX400 F/N/H/S/L/R Micrologic	160						6.9	6.9	6.9	6.9	6.9
	200							6.9	6.9	6.9	6.9
	250								6.9	6.9	6.9
	320									6.9	6.9
400										6.9	

- 4 Selectivity limit = 4 kA.
- T Total selectivity, up to the breaking capacity of the downstream circuit breaker.
- No selectivity.

**Note:** respect the basic rules of selectivity, in terms of overload, short-circuit, ground fault and earth leakage when applicable see page A-2, or check curves with Schneider Electric online "Electrical calculation tools".  
**[1]** Applicable for all "Distribution" Micrologic of Compact NSX range: 2.3, 4.3, 5.3, 6.3, 7.3. For 4.3 and 7.3 selectivity rules for RCD apply in addition. Applicable for Generators and Service connection (G and AB type) Micrologic of Compact NSX range but curves shall be checked.  
 Not applicable for "Motor" Micrologic of Compact NSX range ("M" type).

# Selectivity table

Upstream: Compact NS630b-1600N/H Micrologic

Downstream: iDPN, iC40, iC60, C120, NG125, NSXm, Compact NSXm, NSX100-630

$U_e \leq 440 \text{ V AC}$

A

Upstream		Compact NS630b/800/1000/1250/1600N/H																													
Trip unit		Micrologic 2.0				Micrologic 5.0 - 6.0 - 7.0 Inst 15 In				Micrologic 5.0 - 6.0 - 7.0 Inst OFF																					
Downstream	Rating (A)	630			800			1000			1250			1600			630			800			1000			1250			1600		
	Setting Ir	250	400	630	800	1000	1250	1600	250	400	630	800	1000	1250	1600	250	400	630	800	1000	1250	1600	250	400	630	800	1000	1250	1600		
<b>Selectivity limit (kA)</b>																															
iDPN, iDPNN		T	T	T	T	T	T	T	T	T	T	T	T	T	T	T	T	T	T	T	T	T	T	T	T	T	T	T	T		
iC40, iC40N		T	T	T	T	T	T	T	T	T	T	T	T	T	T	T	T	T	T	T	T	T	T	T	T	T	T	T	T		
iC60N/H/L		T	T	T	T	T	T	T	T	T	T	T	T	T	T	T	T	T	T	T	T	T	T	T	T	T	T	T	T		
C120N/H		T	T	T	T	T	T	T	T	T	T	T	T	T	T	T	T	T	T	T	T	T	T	T	T	T	T	T	T		
NG125N/H		T	T	T	T	T	T	T	T	T	T	T	T	T	T	T	T	T	T	T	T	T	T	T	T	T	T	T	T		
NG125L		T	T	T	T	T	T	T	T	T	T	T	T	T	T	T	T	T	T	T	T	T	T	T	T	T	T	T	T		
Compact NSXm E/B/F/N/H		T	T	T	T	T	T	T	T	T	T	T	T	T	T	T	T	T	T	T	T	T	T	T	T	T	T	T	T		
Compact NSX100 B/F/N/H/S/L/R TM-D		T	T	T	T	T	T	T	T	T	T	T	T	T	T	T	T	T	T	T	T	T	T	T	T	T	T	T	T		
Compact NSX160 B/F/N/H/S/L TM-D		T	T	T	T	T	T	T	T	T	T	T	T	T	T	T	T	T	T	T	T	T	T	T	T	T	T	T	T		
Compact NSX250 $\leq 125$ B/F/N/H/S/L/R TM-D		T	T	T	T	T	T	T	T	T	T	T	T	T	T	T	T	T	T	T	T	T	T	T	T	T	T	T	T		
		160	T	T	T	T	T	T	T	T	T	T	T	T	T	T	T	T	T	T	T	T	T	T	T	T	T	T	T		
		200		T	T	T	T	T	T	T	T	T	T	T	T		T	T	T	T	T	T	T	T	T	T	T	T	T		
		250		T	T	T	T	T	T	T	T	T	T	T	T		T	T	T	T	T	T	T	T	T	T	T	T	T		
Compact NSX100 B/F/N/H/S/L/R Micrologic		40	T	T	T	T	T	T	T	T	T	T	T	T	T	T	T	T	T	T	T	T	T	T	T	T	T	T	T		
		100	T	T	T	T	T	T	T	T	T	T	T	T	T	T	T	T	T	T	T	T	T	T	T	T	T	T	T		
Compact NSX160 B/F/N/H/S/L Micrologic		40	T	T	T	T	T	T	T	T	T	T	T	T	T	T	T	T	T	T	T	T	T	T	T	T	T	T	T		
		100	T	T	T	T	T	T	T	T	T	T	T	T	T	T	T	T	T	T	T	T	T	T	T	T	T	T	T		
		160	T	T	T	T	T	T	T	T	T	T	T	T	T	T	T	T	T	T	T	T	T	T	T	T	T	T	T		
Compact NSX250 $\leq 100$ B/F/N/H/S/L/R Micrologic		160	T	T	T	T	T	T	T	T	T	T	T	T	T	T	T	T	T	T	T	T	T	T	T	T	T	T	T		
		250		T	T	T	T	T	T	T	T	T	T	T	T		T	T	T	T	T	T	T	T	T	T	T	T	T		
Compact NSX400 F/N/H Micrologic		160	T	T	T	T	T	T	T	T	T	T	T	T	T	T	T	T	T	T	T	T	T	T	T	T	T	T	T		
		200		T	T	T	T	T	T	T	T	T	T	T	T		T	T	T	T	T	T	T	T	T	T	T	T	T		
		250		T	T	T	T	T	T	T	T	T	T	T	T		T	T	T	T	T	T	T	T	T	T	T	T	T		
		320			T	T	T	T	T	T	T	T	T	T	T			T	T	T	T	T	T	T	T	T	T	T	T		
		400			T	T	T	T	T	T	T	T	T	T	T			T	T	T	T	T	T	T	T	T	T	T	T		
Compact NSX400 S/L/R Micrologic		160	90	90	90	90	90	90	90	90	90	90	90	90	90	90	90	90	90	90	90	90	90	90	90	90	90	90	90		
		200		90	90	90	90	90	90	90	90	90	90	90	90		90	90	90	90	90	90	90	90	90	90	90	90	90		
		250		90	90	90	90	90	90	90	90	90	90	90	90		90	90	90	90	90	90	90	90	90	90	90	90	90		
		320			90	90	90	90	90	90	90	90	90	90	90			90	90	90	90	90	90	90	90	90	90	90	90		
		400			90	90	90	90	90	90	90	90	90	90	90			90	90	90	90	90	90	90	90	90	90	90	90		
Compact NSX630 F/N Micrologic		250		T	T	T	T	T	T	T	T	T	T	T	T		T	T	T	T	T	T	T	T	T	T	T	T	T		
		320			T	T	T	T	T	T	T	T	T	T	T			T	T	T	T	T	T	T	T	T	T	T	T		
		400			T	T	T	T	T	T	T	T	T	T	T			T	T	T	T	T	T	T	T	T	T	T	T		
		500				T	T	T	T	T	T	T	T	T	T				T	T	T	T	T	T	T	T	T	T	T		
		630					T	T	T	T	T	T	T	T	T					T	T	T	T	T	T	T	T	T	T		
Compact NSX630 H/S/L/R Micrologic		250		65	65	65	65	65	65	65	65	65	65	65	65	65	65	65	65	65	65	65	65	65	65	65	65	65	65		
		320			65	65	65	65	65	65	65	65	65	65	65		65	65	65	65	65	65	65	65	65	65	65	65	65		
		400			65	65	65	65	65	65	65	65	65	65	65		65	65	65	65	65	65	65	65	65	65	65	65	65		
		500				65	65	65	65	65	65	65	65	65	65			65	65	65	65	65	65	65	65	65	65	65	65		
		630					65	65	65	65	65	65	65	65	65				65	65	65	65	65	65	65	65	65	65	65		

**T** Total selectivity, up to the breaking capacity of the downstream circuit breaker.

**4** Selectivity limit = 4 kA.

No selectivity.

**Note:** respect the basic rules of selectivity, in terms of overload, short-circuit, ground fault and earth leakage when applicable see page A-2, or check curves with Schneider Electric online "Electrical calculation tools".

# Selectivity table

Upstream: Compact NS630b-1600N/H Micrologic

Downstream: Compact NS630b-1600

Ue ≤ 440 V AC



Upstream		Compact NS630b/800/1000/1250/1600N/H																	
Trip unit		Micrologic 2.0						Micrologic 5.0 - 6.0 - 7.0 Inst 15 In						Micrologic 5.0 - 6.0 - 7.0 Inst OFF					
Downstream	Rating (A)	630		800	1000	1250	1600	630		800	1000	1250	1600	630		800	1000	1250	1600
	Setting Ir	400	630	800	1000	1250	1600	400	630	800	1000	1250	1600	400	630	800	1000	1250	1600
<b>Selectivity limit (kA)</b>																			
<b>Compact NS630bN/H</b> Micrologic	250	4	6.3	8	10	12.5	16	9.4	9.4	12	15	18	18	18	18	18	18	18	18
	320		6.3	8	10	12.5	16		9.4	12	15	18	18		18	18	18	18	18
	400		6.3	8	10	12.5	16		9.4	12	15	18	18		18	18	18	18	18
	500			8	10	12.5	16			12	15	18	18			18	18	18	18
	630				10	12.5	16				15	18	18				18	18	18
<b>Compact NS800N/H</b> Micrologic	320		6.3	8	10	12.5	16		9.4	12	15	18	18		18	18	18	18	18
	400		6.3	8	10	12.5	16		9.4	12	15	18	18		18	18	18	18	18
	500			8	10	12.5	16			12	15	18	18			18	18	18	18
	630				10	12.5	16				15	18	18			18	18	18	18
	800					12.5	16					18	18				18	18	18
<b>Compact NS1000N/H</b> Micrologic	400		6.3	8	10	12.5	16		9.4	12	15	18	18		18	18	18	18	18
	500			8	10	12.5	16			12	15	18	18			18	18	18	18
	630				10	12.5	16				15	18	18				18	18	18
	800					12.5	16					18	18					18	18
	1000						16						18						18
<b>Compact NS1250N/H</b> Micrologic	500			8	10	12.5	16			12	15	18	18			18	18	18	18
	630				10	12.5	16				15	18	18				18	18	18
	800					12.5	16					18	18					18	18
	1000						16						18						18
	1250																		18
<b>Compact NS1600N/H</b> Micrologic	630				10	12.5	16				15	18	18				18	18	18
	800					12.5	16					18	18					18	18
	960						16						18						18
	1250																		
	1600																		
<b>Compact NS630bL/LB</b> Micrologic	250	4	6.3	8	10	12.5	16	9.4	9.4	12	15	18.7	24	30	30	30	30	30	30
	320		6.3	8	10	12.5	16		9.4	12	15	18.7	24		30	30	30	30	30
	400		6.3	8	10	12.5	16		9.4	12	15	18.7	24		30	30	30	30	30
	500			8	10	12.5	16			12	15	18.7	24			30	30	30	30
	630				10	12.5	16				15	18.7	24				30	30	30
<b>Compact NS800L/LB</b> Micrologic	320		6.3	8	10	12.5	16		9.4	12	15	18.7	24		30	30	30	30	30
	400		6.3	8	10	12.5	16		9.4	12	15	18.7	24		30	30	30	30	30
	500			8	10	12.5	16			12	15	18.7	24			30	30	30	30
	630				10	12.5	16				15	18.7	24				30	30	30
	800					12.5	16					18.7	24					30	30
<b>Compact NS1000L</b> Micrologic	400		6.3	8	10	12.5	16		9.4	12	15	18.7	24		30	30	30	30	30
	500			8	10	12.5	16			12	15	18.7	24			30	30	30	30
	630				10	12.5	16				15	18.7	24				30	30	30
	800					12.5	16					18.7	24					30	30
	1000						16						24						30

4 Selectivity limit = 4 kA.

No selectivity.

**Note:** respect the basic rules of selectivity, in terms of overload, short-circuit, ground fault and earth leakage when applicable see page A-2, or check curves with Schneider Electric online "Electrical calculation tools".

# Selectivity table

Upstream: Compact NS1600b-3200N Micrologic

Downstream: iDPN, iC40, iC60, C120, NG125, Compact NSXm, NSX100-630, NS630b-3200

Ue ≤ 440 V AC

A

Upstream		Compact NS1600b/2000/2500/3200N											
Trip unit		Micrologic 2.0				Micrologic 5.0 - 6.0 - 7.0 Inst 15In				Micrologic 5.0 - 6.0 - 7.0 Inst OFF			
Downstream	Rating (A)	1600	2000	2500	3200	1600	2000	2500	3200	1600	2000	2500	3200
<b>Selectivity limit (kA)</b>													
iDPN, iDPNN		T	T	T	T	T	T	T	T	T	T	T	T
iC40, iC40N		T	T	T	T	T	T	T	T	T	T	T	T
iC60N/H/L		T	T	T	T	T	T	T	T	T	T	T	T
C120N/H		T	T	T	T	T	T	T	T	T	T	T	T
NG125N/H		T	T	T	T	T	T	T	T	T	T	T	T
NG125L		T	T	T	T	T	T	T	T	T	T	T	T
Compact NSXm E/B/F/N/H		T	T	T	T	T	T	T	T	T	T	T	T
Compact NSX B/F/N/H/S/L/R TM-D	NSX100	T	T	T	T	T	T	T	T	T	T	T	T
	NSX250	T	T	T	T	T	T	T	T	T	T	T	T
Compact NSX160 B/F/N/H/S/L TM-D		T	T	T	T	T	T	T	T	T	T	T	T
Compact NSX B/F/N/H/S/L/R Micrologic	NSX100	T	T	T	T	T	T	T	T	T	T	T	T
	NSX250	T	T	T	T	T	T	T	T	T	T	T	T
Compact NSX160 B/F/N/H/S/L Micrologic		T	T	T	T	T	T	T	T	T	T	T	T
Compact NSX F/N/H/S/L/R	NSX400	T	T	T	T	T	T	T	T	T	T	T	T
	NSX630	T	T	T	T	T	T	T	T	T	T	T	T
Compact NS N	NS630b	16	20	25	32	24	30	37.5	48	T	T	T	T
	NS800	16	20	25	32	24	30	37.5	48	T	T	T	T
	NS1000	16	20	25	32	24	30	37.5	48	T	T	T	T
	NS1250		20	25	32		30	37.5	48		T	T	T
	NS1600			25	32			37.5	48			T	T
Compact NS H	NS630b	16	20	25	32	24	30	37.5	48	60	60	60	60
	NS800	16	20	25	32	24	30	37.5	48	60	60	60	60
	NS1000	16	20	25	32	24	30	37.5	48	60	60	60	60
	NS1250		20	25	32		30	37.5	48		60	60	60
	NS1600			25	32			37.5	48			60	60
Compact NS N/H	NS1600b			25	32			37.5	48			60	60
	NS2000				32				48				60
	NS2500												
	NS3200												
Compact NS L/LB	NS630bL/LB	T	T	T	T	T	T	T	T	T	T	T	T
	NS800L/LB	T	T	T	T	T	T	T	T	T	T	T	T
	NS1000L	T	T	T	T	T	T	T	T	T	T	T	T

Total selectivity, up to the breaking capacity of the downstream circuit breaker.

Selectivity limit = 4 kA.

No selectivity.

**Note:** respect the basic rules of selectivity, in terms of overload, short-circuit, ground fault and earth leakage when applicable see page A-2, or check curves with Schneider Electric online "Electrical calculation tools".

# Selectivity table

Upstream: Compact NS1600b-3200H Micrologic

Downstream: iDPN, iC60, C120, NG125, NSX100-630, NS630b-3200

Ue ≤ 440 V AC



Upstream		Compact NS1600b/2000/2500/3200H											
Trip unit		Micrologic 2.0				Micrologic 5.0 - 6.0 - 7.0 Inst 15 In				Micrologic 5.0 - 6.0 - 7.0 Inst OFF			
Downstream	Rating (A)	1600	2000	2500	3200	1600	2000	2500	3200	1600	2000	2500	3200
<b>Selectivity limit (kA)</b>													
iDPN, iDPNN		T	T	T	T	T	T	T	T	T	T	T	T
iC60N/H/L		T	T	T	T	T	T	T	T	T	T	T	T
C120N/H		T	T	T	T	T	T	T	T	T	T	T	T
NG125N/H		T	T	T	T	T	T	T	T	T	T	T	T
NG125L		T <sup>[1]</sup>	T <sup>[1]</sup>	T <sup>[1]</sup>	T <sup>[1]</sup>	T <sup>[1]</sup>	T <sup>[1]</sup>	T <sup>[1]</sup>	T <sup>[1]</sup>	T <sup>[1]</sup>	T <sup>[1]</sup>	T <sup>[1]</sup>	T <sup>[1]</sup>
Compact NSXm E/B/F		T	T	T	T	T	T	T	T	T	T	T	T
Compact NSXm N/H		T <sup>[1]</sup>	T <sup>[1]</sup>	T <sup>[1]</sup>	T <sup>[1]</sup>	T <sup>[1]</sup>	T <sup>[1]</sup>	T <sup>[1]</sup>	T <sup>[1]</sup>	T <sup>[1]</sup>	T <sup>[1]</sup>	T <sup>[1]</sup>	T <sup>[1]</sup>
Compact NSX B/F TM-D	NSX100	T	T	T	T	T	T	T	T	T	T	T	T
	NSX160	T	T	T	T	T	T	T	T	T	T	T	T
	NSX250	T	T	T	T	T	T	T	T	T	T	T	T
Compact NSX B/F Micrologic	NSX100	T	T	T	T	T	T	T	T	T	T	T	T
	NSX160	T	T	T	T	T	T	T	T	T	T	T	T
	NSX250	T	T	T	T	T	T	T	T	T	T	T	T
Compact NSX F	NSX400	T	T	T	T	T	T	T	T	T	T	T	T
	NSX630	T	T	T	T	T	T	T	T	T	T	T	T
Compact NSX N/H/S/L/R TM-D	NSX100	T <sup>[1]</sup>	T <sup>[1]</sup>	T <sup>[1]</sup>	T <sup>[1]</sup>	T <sup>[1]</sup>	T <sup>[1]</sup>	T <sup>[1]</sup>	T <sup>[1]</sup>	T <sup>[1]</sup>	T <sup>[1]</sup>	T <sup>[1]</sup>	T <sup>[1]</sup>
	NSX250	T <sup>[1]</sup>	T <sup>[1]</sup>	T <sup>[1]</sup>	T <sup>[1]</sup>	T <sup>[1]</sup>	T <sup>[1]</sup>	T <sup>[1]</sup>	T <sup>[1]</sup>	T <sup>[1]</sup>	T <sup>[1]</sup>	T <sup>[1]</sup>	T <sup>[1]</sup>
Compact NSX160 N/H/S/L TM-D		T <sup>[1]</sup>	T <sup>[1]</sup>	T <sup>[1]</sup>	T <sup>[1]</sup>	T <sup>[1]</sup>	T <sup>[1]</sup>	T <sup>[1]</sup>	T <sup>[1]</sup>	T <sup>[1]</sup>	T <sup>[1]</sup>	T <sup>[1]</sup>	T <sup>[1]</sup>
Compact NSX N/H/S/L/R Micrologic	NSX100	T <sup>[1]</sup>	T <sup>[1]</sup>	T <sup>[1]</sup>	T <sup>[1]</sup>	T <sup>[1]</sup>	T <sup>[1]</sup>	T <sup>[1]</sup>	T <sup>[1]</sup>	T <sup>[1]</sup>	T <sup>[1]</sup>	T <sup>[1]</sup>	T <sup>[1]</sup>
	NSX250	T <sup>[1]</sup>	T <sup>[1]</sup>	T <sup>[1]</sup>	T <sup>[1]</sup>	T <sup>[1]</sup>	T <sup>[1]</sup>	T <sup>[1]</sup>	T <sup>[1]</sup>	T <sup>[1]</sup>	T <sup>[1]</sup>	T <sup>[1]</sup>	T <sup>[1]</sup>
Compact NSX160 N/H/S/L Micrologic		T <sup>[1]</sup>	T <sup>[1]</sup>	T <sup>[1]</sup>	T <sup>[1]</sup>	T <sup>[1]</sup>	T <sup>[1]</sup>	T <sup>[1]</sup>	T <sup>[1]</sup>	T <sup>[1]</sup>	T <sup>[1]</sup>	T <sup>[1]</sup>	T <sup>[1]</sup>
Compact NSX N/H/S/L/R	NSX400	T <sup>[1]</sup>	T <sup>[1]</sup>	T <sup>[1]</sup>	T <sup>[1]</sup>	T <sup>[1]</sup>	T <sup>[1]</sup>	T <sup>[1]</sup>	T <sup>[1]</sup>	T <sup>[1]</sup>	T <sup>[1]</sup>	T <sup>[1]</sup>	T <sup>[1]</sup>
	NSX630	T <sup>[1]</sup>	T <sup>[1]</sup>	T <sup>[1]</sup>	T <sup>[1]</sup>	T <sup>[1]</sup>	T <sup>[1]</sup>	T <sup>[1]</sup>	T <sup>[1]</sup>	T <sup>[1]</sup>	T <sup>[1]</sup>	T <sup>[1]</sup>	T <sup>[1]</sup>
Compact NS N	NS630b	16	20	25	32	24	30	37.5	42 <sup>[1]</sup>	42 <sup>[1]</sup>	42 <sup>[1]</sup>	42 <sup>[1]</sup>	42 <sup>[1]</sup>
	NS800	16	20	25	32	24	30	37.5	42 <sup>[1]</sup>	42 <sup>[1]</sup>	42 <sup>[1]</sup>	42 <sup>[1]</sup>	42 <sup>[1]</sup>
	NS1000	16	20	25	32	24	30	37.5	42 <sup>[1]</sup>	42 <sup>[1]</sup>	42 <sup>[1]</sup>	42 <sup>[1]</sup>	42 <sup>[1]</sup>
	NS1250		20	25	32		30	37.5	42 <sup>[1]</sup>		42 <sup>[1]</sup>	42 <sup>[1]</sup>	42 <sup>[1]</sup>
	NS1600			25	32			37.5	42 <sup>[1]</sup>			42 <sup>[1]</sup>	42 <sup>[1]</sup>
Compact NS H	NS630b	16	20	25	32	24	30	37.5	42 <sup>[1]</sup>	42 <sup>[1]</sup>	42 <sup>[1]</sup>	42 <sup>[1]</sup>	42 <sup>[1]</sup>
	NS800	16	20	25	32	24	30	37.5	42 <sup>[1]</sup>	42 <sup>[1]</sup>	42 <sup>[1]</sup>	42 <sup>[1]</sup>	42 <sup>[1]</sup>
	NS1000	16	20	25	32	24	30	37.5	42 <sup>[1]</sup>	42 <sup>[1]</sup>	42 <sup>[1]</sup>	42 <sup>[1]</sup>	42 <sup>[1]</sup>
	NS1250		20	25	32		30	37.5	42 <sup>[1]</sup>		42 <sup>[1]</sup>	42 <sup>[1]</sup>	42 <sup>[1]</sup>
	NS1600			25	32			37.5	42 <sup>[1]</sup>			42 <sup>[1]</sup>	42 <sup>[1]</sup>
Compact NS N/H	NS1600b			25	32			37.5	42 <sup>[1]</sup>			42 <sup>[1]</sup>	42 <sup>[1]</sup>
	NS2000				32				42 <sup>[1]</sup>				42 <sup>[1]</sup>
	NS2500												
	NS3200												
Compact NS L/LB	NS630bL/LB	T	T	T	T	T	T	T	T	T	T	T	T
	NS800L/LB	T	T	T	T	T	T	T	T	T	T	T	T
	NS1000L	T	T	T	T	T	T	T	T	T	T	T	T

**T** Total selectivity, up to the breaking capacity of the downstream circuit breaker.

**4** Selectivity limit = 4 kA.

No selectivity.

[1] 40 kA for Compact NS1600b..3200H manufactured before 2015.

Note: respect the basic rules of selectivity, in terms of overload, short-circuit, ground fault and earth leakage when applicable see page A-2, or check curves with Schneider Electric online "Electrical calculation tools".

# Selectivity table

Upstream: Compact NS630b-1000L, Compact NS630b-800LB Micrologic

Downstream: iDPN, iC40, iC60, C120, NG125, Compact NSXm, NSX100-630

Ue ≤ 440 V AC

A

Upstream		Compact NS630b/800/1000L Compact NS630b/800LB														
Trip unit		Micrologic 2.0					Micrologic 5.0 - 6.0 - 7.0 Inst 15 In					Micrologic 5.0 - 6.0 - 7.0 Inst OFF				
Downstream	Rating (A)	630			800	1000	630			800	1000	630			800	1000
	Setting Ir	250	400	630	800	1000	250	400	630	800	1000	250	400	630	800	1000
Selectivity limit (kA)																
iDPN, iDPNN		T	T	T	T	T	T	T	T	T	T	T	T	T	T	T
iC40, iC40N		T	T	T	T	T	T	T	T	T	T	T	T	T	T	T
iC60N/H/L		T	T	T	T	T	T	T	T	T	T	T	T	T	T	T
C120N/H		T	T	T	T	T	T	T	T	T	T	T	T	T	T	T
NG125N/H		T	T	T	T	T	T	T	T	T	T	T	T	T	T	T
NG125L		T	T	T	T	T	T	T	T	T	T	T	T	T	T	T
Compact NSXm E/B/F/N/H		T	T	T	T	T	T	T	T	T	T	T	T	T	T	T
Compact NSX100 B/F/N/H/S/L/R TM-D		T	T	T	T	T	T	T	T	T	T	T	T	T	T	T
Compact NSX160 B/F TM-D		T	T	T	T	T	T	T	T	T	T	T	T	T	T	T
Compact NSX160 N/H/S/L TM-D		36	36	36	T	T	36	36	36	T	T	36	36	36	T	T
Compact NSX250 B/F/N/H/S/L/R TM-D	≤ 125	20	20	20	T	T	20	20	20	T	T	20	20	20	T	T
	160	20	20	20	T	T	20	20	20	T	T	20	20	20	T	T
	200		20	20	T	T		20	20	T	T		20	20	T	T
	250		20	20	T	T		20	20	T	T		20	20	T	T
Compact NSX100 B/F/N/H/S/L/R Micrologic	40	T	T	T	T	T	T	T	T	T	T	T	T	T	T	T
	100	T	T	T	T	T	T	T	T	T	T	T	T	T	T	T
Compact NSX160 B/F Micrologic	40	T	T	T	T	T	T	T	T	T	T	T	T	T	T	T
	100	T	T	T	T	T	T	T	T	T	T	T	T	T	T	T
	160	T	T	T	T	T	T	T	T	T	T	T	T	T	T	T
Compact NSX160 N/H/S/L Micrologic	40	36	36	36	T	T	36	36	36	T	T	36	36	36	T	T
	100	36	36	36	T	T	36	36	36	T	T	36	36	36	T	T
	160	36	36	36	T	T	36	36	36	T	T	36	36	36	T	T
Compact NSX250 B/F/N/H/S/L/R Micrologic	≤ 100	20	20	20	T	T	20	20	20	T	T	20	20	20	T	T
	160		20	20	T	T		20	20	T	T		20	20	T	T
	250		20	20	T	T		20	20	T	T		20	20	T	T
Compact NSX400 F/N/H/S/L/R Micrologic	160	6.3	6.3	6.3	10	15	6.3	6.3	6.3	10	15	6.3	6.3	6.3	10	15
	200		6.3	6.3	10	15		6.3	6.3	10	15		6.3	6.3	10	15
	250		6.3	6.3	10	15		6.3	6.3	10	15		6.3	6.3	10	15
	320		6.3	6.3	10	15			6.3	10	15			6.3	10	15
	400			6.3	10	15			6.3	10	15			6.3	10	15
Compact NSX630 F/N/H/S/L/R Micrologic	250		6.3	6.3	8	10		6.3	6.3	8	10		6.3	6.3	8	10
	320			6.3	8	10			6.3	8	10			6.3	8	10
	400			6.3	8	10			6.3	8	10			6.3	8	10
	500				8	10				8	10				8	10
	630					10					10					10

T Total selectivity, up to the breaking capacity of the downstream circuit breaker.

4 Selectivity limit = 4 kA.

No selectivity.

**Note:** respect the basic rules of selectivity, in terms of overload, short-circuit, ground fault and earth leakage when applicable see page A-2, or check curves with Schneider Electric online "Electrical calculation tools".

# Selectivity table

Upstream: Compact NS630b-1000L, Compact NS630b-800LB Micrologic

Downstream: Compact NS630b-1000

$U_e \leq 440 \text{ V AC}$



Upstream		Compact NS630b/800/1000L Compact NS630b/800LB														
Trip unit		Micrologic 2.0					Micrologic 5.0 - 6.0 - 7.0 Inst 15 In					Micrologic 5.0 - 6.0 - 7.0 Inst OFF				

Downstream	Rating (A)	630			800	1000	630			800	1000	630			800	1000
		Setting Ir	250	400	630	800	1000	250	400	630	800	1000	250	400	630	800
<b>Selectivity limit (kA)</b>																
Compact NS630b N/H Micrologic	250		6.3	6.3	8	10		6.3	6.3	8	10		6.3	6.3	8	10
	320			6.3	8	10			6.3	8	10			6.3	8	10
	400			6.3	8	10			6.3	8	10			6.3	8	10
	500				8	10				8	10				8	10
	630					10					10					10
Compact NS800 N/H Micrologic	320			6.3	8	10			6.3	8	10			6.3	8	10
	400			6.3	8	10			6.3	8	10			6.3	8	10
	500				8	10				8	10			8	10	
	630					10					10				10	
	800															
Compact NS1000 N/H Micrologic	400			6.3	8	10			6.3	8	10			6.3	8	10
	500				8	10				8	10			8	10	
	630					10					10				10	
	800															
	1000															
Compact NS630b L/LB Micrologic	250		6.3	6.3	8	10		6.3	6.3	8	10		6.3	6.3	8	10
	320			6.3	8	10			6.3	8	10			6.3	8	10
	400			6.3	8	10			6.3	8	10			6.3	8	10
	500				8	10				8	10			8	10	
	630					10					10				10	
Compact NS800 L/LB Micrologic	320			6.3	8	10			6.3	8	10			6.3	8	10
	400			6.3	8	10			6.3	8	10			6.3	8	10
	500				8	10				8	10			8	10	
	630					10					10				10	
	800															
Compact NS1000 L Micrologic	400			6.3	8	10			6.3	8	10			6.3	8	10
	500				8	10				8	10			8	10	
	630					10					10				10	
	800															
	1000															

Selectivity limit = 4 kA.

No selectivity.

**Note:** respect the basic rules of selectivity, in terms of overload, short-circuit, ground fault and earth leakage when applicable see page A-2, or check curves with Schneider Electric online "Electrical calculation tools".

# Selectivity table

Upstream: Masterpact MTZ1 06-16 H1/H2/H3 Micrologic X

Downstream: iDPN, iC40, iC60, C120, NG125, Compact NSXm, NSX100-630



Ue ≤ 440 V AC

Upstream		Masterpact MTZ1 06/08/10/12/16 H1/H2/H3																													
Trip unit		Micrologic 2.0X Isd = 10Ir				Micrologic 5.0X - 6.0X - 7.0X Inst : 15 In Standard				Micrologic 5.0X - 6.0X - 7.0X Inst : OFF																					
Downstream	Rating (A)	630			800			1000			1250			1600			630			800			1000			1250			1600		
	Setting Ir	250	400	630	800	1000	1250	1600	250	400	630	800	1000	1250	1600	250	400	630	800	1000	1250	1600	250	400	630	800	1000	1250	1600		
Selectivity limit (kA)																															
iDPN, iDPNN		T	T	T	T	T	T	T	T	T	T	T	T	T	T	T	T	T	T	T	T	T	T	T	T	T	T	T	T		
iC40, iC40N		T	T	T	T	T	T	T	T	T	T	T	T	T	T	T	T	T	T	T	T	T	T	T	T	T	T	T	T		
iC60N/H/L		T	T	T	T	T	T	T	T	T	T	T	T	T	T	T	T	T	T	T	T	T	T	T	T	T	T	T	T		
C120N/H		T	T	T	T	T	T	T	T	T	T	T	T	T	T	T	T	T	T	T	T	T	T	T	T	T	T	T	T		
NG125N/H		T	T	T	T	T	T	T	T	T	T	T	T	T	T	T	T	T	T	T	T	T	T	T	T	T	T	T	T		
NG125L		T	T	T	T	T	T	T	T	T	T	T	T	T	T	T	T	T	T	T	T	T	T	T	T	T	T	T	T		
NSXm E/B/F/N/H		T	T	T	T	T	T	T	T	T	T	T	T	T	T	T	T	T	T	T	T	T	T	T	T	T	T	T	T		
Compact NSX100 B/F/N/H/S/L/R TM-D		T	T	T	T	T	T	T	T	T	T	T	T	T	T	T	T	T	T	T	T	T	T	T	T	T	T	T	T		
Compact NSX160 B/F/N/H/S/L TM-D		T	T	T	T	T	T	T	T	T	T	T	T	T	T	T	T	T	T	T	T	T	T	T	T	T	T	T	T		
Compact NSX250 ≤ 125 B/F/N/H/S/L/R TM-D		T	T	T	T	T	T	T	T	T	T	T	T	T	T	T	T	T	T	T	T	T	T	T	T	T	T	T	T		
		160	T	T	T	T	T	T	T	T	T	T	T	T	T	T	T	T	T	T	T	T	T	T	T	T	T	T	T		
		200	T	T	T	T	T	T	T	T	T	T	T	T	T	T	T	T	T	T	T	T	T	T	T	T	T	T	T		
		250	T	T	T	T	T	T	T	T	T	T	T	T	T	T	T	T	T	T	T	T	T	T	T	T	T	T	T		
Compact NSX100 40 B/F/N/H/S/L/R Micrologic		100	T	T	T	T	T	T	T	T	T	T	T	T	T	T	T	T	T	T	T	T	T	T	T	T	T	T	T		
Compact NSX160 40 B/F/N/H/S/L Micrologic		100	T	T	T	T	T	T	T	T	T	T	T	T	T	T	T	T	T	T	T	T	T	T	T	T	T	T	T		
		160	T	T	T	T	T	T	T	T	T	T	T	T	T	T	T	T	T	T	T	T	T	T	T	T	T	T	T		
Compact NSX250 ≤ 100 B/F/N/H/S/L/R Micrologic		160	T	T	T	T	T	T	T	T	T	T	T	T	T	T	T	T	T	T	T	T	T	T	T	T	T	T	T		
		250	T	T	T	T	T	T	T	T	T	T	T	T	T	T	T	T	T	T	T	T	T	T	T	T	T	T	T		
Compact NSX400 160 F/N/H/S/L/R Micrologic		200	T	T	T	T	T	T	T	T	T	T	T	T	T	T	T	T	T	T	T	T	T	T	T	T	T	T	T		
		250	T	T	T	T	T	T	T	T	T	T	T	T	T	T	T	T	T	T	T	T	T	T	T	T	T	T	T		
		320	T	T	T	T	T	T	T	T	T	T	T	T	T	T	T	T	T	T	T	T	T	T	T	T	T	T	T		
		400	T	T	T	T	T	T	T	T	T	T	T	T	T	T	T	T	T	T	T	T	T	T	T	T	T	T	T		
Compact NSX630 250 F/N/H/S/L/R Micrologic		320	T	T	T	T	T	T	T	T	T	T	T	T	T	T	T	T	T	T	T	T	T	T	T	T	T	T	T		
		400	T	T	T	T	T	T	T	T	T	T	T	T	T	T	T	T	T	T	T	T	T	T	T	T	T	T	T		
		500	T	T	T	T	T	T	T	T	T	T	T	T	T	T	T	T	T	T	T	T	T	T	T	T	T	T	T		
		630	T	T	T	T	T	T	T	T	T	T	T	T	T	T	T	T	T	T	T	T	T	T	T	T	T	T	T		

T Total selectivity, up to the breaking capacity of the downstream circuit breaker.

No selectivity.

**Note:** respect the basic rules of selectivity, in terms of overload, short-circuit, ground fault and earth leakage when applicable see page A-2, or check curves with Schneider Electric online "Electrical calculation tools".



# Selectivity table

Upstream: Masterpact MTZ1 06-16 H1 Micrologic X

Downstream: Compact NS630b-1600 Micrologic A/E/P

Ue ≤ 440 V AC



Upstream		Masterpact MTZ1 06/08/10/12/16 H1																			
Trip unit		Micrologic 2.0X Isd = 10Ir				Micrologic 5.0X - 6.0X - 7.0X Inst : 15 in Standard				Micrologic 5.0X - 6.0X - 7.0X Inst : OFF											
Downstream	Rating (A)	630		800		1000		1250		1600		630		800		1000		1250		1600	
	Setting Ir	400	630	800	1000	1250	1600	400	630	800	1000	1250	1600	400	630	800	1000	1250	1600		
<b>Selectivity limit (kA)</b>																					
<b>Compact NS630b</b>	<b>250</b>	4	6.3	8	10	12.5	16	9.4	9.4	12	15	18.7	24	T	T	T	T	T	T	T	T
<b>N/H</b>	<b>320</b>		6.3	8	10	12.5	16		9.4	12	15	18.7	24		T	T	T	T	T	T	T
Micrologic	<b>400</b>		6.3	8	10	12.5	16		9.4	12	15	18.7	24		T	T	T	T	T	T	T
2.0 - 5.0 - 6.0 - 7.0	<b>500</b>			8	10	12.5	16			12	15	18.7	24			T	T	T	T	T	T
A/E/P	<b>630</b>				10	12.5	16				15	18.7	24				T	T	T	T	T
<b>Compact NS800</b>	<b>320</b>		6.3	8	10	12.5	16		9.4	12	15	18.7	24		T	T	T	T	T	T	T
<b>N/H</b>	<b>400</b>		6.3	8	10	12.5	16		9.4	12	15	18.7	24		T	T	T	T	T	T	T
Micrologic	<b>500</b>			8	10	12.5	16			12	15	18.7	24			T	T	T	T	T	T
2.0 - 5.0 - 6.0 - 7.0	<b>630</b>				10	12.5	16				15	18.7	24			T	T	T	T	T	T
A/E/P	<b>800</b>					12.5	16					18.7	24				T	T	T	T	T
<b>Compact NS1000</b>	<b>400</b>		6.3	8	10	12.5	16		9.4	12	15	18.7	24		T	T	T	T	T	T	T
<b>N/H</b>	<b>500</b>			8	10	12.5	16			12	15	18.7	24			T	T	T	T	T	T
Micrologic	<b>630</b>				10	12.5	16				15	18.7	24				T	T	T	T	T
2.0 - 5.0 - 6.0 - 7.0	<b>800</b>					12.5	16					18.7	24					T	T	T	T
A/E/P	<b>1000</b>						16						24								T
<b>Compact NS1250</b>	<b>500</b>			8	10	12.5	16			12	15	18.7	24			T	T	T	T	T	T
<b>N/H</b>	<b>630</b>				10	12.5	16				15	18.7	24				T	T	T	T	T
Micrologic	<b>800</b>					12.5	16					18.7	24					T	T	T	T
2.0 - 5.0 - 6.0 - 7.0	<b>1000</b>						16						24								T
A/E/P	<b>1250</b>																				
<b>Compact NS1600</b>	<b>630</b>				10	12.5	16				15	18.7	24					T	T	T	T
<b>N/H</b>	<b>800</b>					12.5	16					18.7	24						T	T	T
Micrologic	<b>960</b>						16						24								T
2.0 - 5.0 - 6.0 - 7.0	<b>1250</b>																				
A/E/P	<b>1600</b>																				
<b>Compact NS630b</b>	<b>250</b>	4	6.3	8	T	T	T	T	T	T	T	T	T	T	T	T	T	T	T	T	T
<b>L/LB</b>	<b>320</b>		6.3	8	T	T	T	T	T	T	T	T	T	T	T	T	T	T	T	T	T
Micrologic	<b>400</b>		6.3	8	T	T	T	T	T	T	T	T	T	T	T	T	T	T	T	T	T
2.0 - 5.0 - 6.0 - 7.0	<b>500</b>			8	T	T	T	T	T	T	T	T	T	T	T	T	T	T	T	T	T
A/E/P	<b>630</b>				T	T	T	T	T	T	T	T	T	T	T	T	T	T	T	T	T
<b>Compact NS800</b>	<b>320</b>		6.3	8	10	T	T		9.4	T	T	T	T		T	T	T	T	T	T	T
<b>L/LB</b>	<b>400</b>		6.3	8	10	T	T		9.4	T	T	T	T		T	T	T	T	T	T	T
Micrologic	<b>500</b>			8	10	T	T			T	T	T	T			T	T	T	T	T	T
2.0 - 5.0 - 6.0 - 7.0	<b>630</b>				10	T	T				T	T	T				T	T	T	T	T
A/E/P	<b>800</b>					12.5	T					T	T								T
<b>Compact NS1000</b>	<b>400</b>		6.3	8	10	12.5	T		9.4	12	T	T	T		T	T	T	T	T	T	T
<b>L</b>	<b>500</b>			8	10	12.5	T			12	T	T	T			T	T	T	T	T	T
Micrologic	<b>630</b>				10	12.5	T				T	T	T				T	T	T	T	T
2.0 - 5.0 - 6.0 - 7.0	<b>800</b>					12.5	T					T	T								T
A/E/P	<b>1000</b>						T						T								T

**T** Total selectivity, up to the breaking capacity of the downstream circuit breaker.

**4** Selectivity limit = 4 kA.

No selectivity.

**Note:** respect the basic rules of selectivity, in terms of overload, short-circuit, ground fault and earth leakage when applicable see page A-2, or check curves with Schneider Electric online "Electrical calculation tools".

# Selectivity table

Upstream: Masterpact MTZ1 06-16 H1 Micrologic X

Downstream: Masterpact MTZ1 06-16

U<sub>e</sub> ≤ 440 V AC

A

Upstream		Masterpact MTZ1 06/08/10/12/16 H1																	
Trip unit		Micrologic 2.0X Isd = 10Ir						Micrologic 5.0X - 6.0X - 7.0X Inst : 15 In Standard						Micrologic 5.0X - 6.0X - 7.0X Inst : OFF					
Downstream	Rating (A)	630		800	1000	1250	1600	630		800	1000	1250	1600	630		800	1000	1250	1600
	Setting Ir	400	630	800	1000	1250	1600	400	630	800	1000	1250	1600	400	630	800	1000	1250	1600
<b>Selectivity limit (kA)</b>																			
Masterpact MTZ1 06 H1/H2/H3	250	4	6.3	8	10	12.5	16	9.4	9.4	12	15	18.7	24	T	T	T	T	T	T
	320		6.3	8	10	12.5	16		9.4	12	15	18.7	24		T	T	T	T	T
	400		6.3	8	10	12.5	16		9.4	12	15	18.7	24		T	T	T	T	T
	500			8	10	12.5	16			12	15	18.7	24			T	T	T	T
	630				10	12.5	16				15	18.7	24				T	T	T
Masterpact MTZ1 08 H1/H2/H3	320		6.3	8	10	12.5	16		9.4	12	15	18.7	24		T	T	T	T	T
	400		6.3	8	10	12.5	16		9.4	12	15	18.7	24		T	T	T	T	T
	500			8	10	12.5	16			12	15	18.7	24			T	T	T	T
	630				10	12.5	16				15	18.7	24			T	T	T	T
	800					12.5	16					18.7	24				T	T	T
Masterpact MTZ1 10 H1/H2/H3	400		6.3	8	10	12.5	16		9.4	12	15	18.7	24		T	T	T	T	T
	500			8	10	12.5	16			12	15	18.7	24		T	T	T	T	T
	630				10	12.5	16				15	18.7	24			T	T	T	T
	800					12.5	16					18.7	24				T	T	T
	1000						16						24					T	T
Masterpact MTZ1 12 H1/H2/H3	500			8	10	12.5	16			12	15	18.7	24			T	T	T	T
	630				10	12.5	16				15	18.7	24			T	T	T	T
	800					12.5	16					18.7	24				T	T	T
	1000						16						24					T	T
	1250																		T
Masterpact MTZ1 16 H1/H2/H3	630				10	12.5	16				15	18.7	24				T	T	T
	800					12.5	16					18.7	24					T	T
	960						16						24						T
	1250																		
	1600																		
Masterpact MTZ1 06 L1	250	4	6.3	8	T	T	T	T	T	T	T	T	T	T	T	T	T	T	T
	320		6.3	8	T	T	T		T	T	T	T	T		T	T	T	T	T
	400		6.3	8	T	T	T		T	T	T	T	T		T	T	T	T	T
	500			8	T	T	T			T	T	T	T			T	T	T	T
	630				T	T	T				T	T	T				T	T	T
Masterpact MTZ1 08 L1	320		6.3	8	10	T	T		9.4	T	T	T	T		T	T	T	T	T
	400		6.3	8	10	T	T		9.4	T	T	T	T		T	T	T	T	T
	500			8	10	T	T			T	T	T	T			T	T	T	T
	630				10	T	T				T	T	T				T	T	T
	800					T	T					T	T					T	T
Masterpact MTZ1 10 L1	400		6.3	8	10	12.5	T		9.4	12	T	T	T		T	T	T	T	T
	500			8	10	12.5	T			12	T	T	T			T	T	T	T
	630				10	12.5	T				T	T	T				T	T	T
	800					12.5	T					T	T					T	T
	1000						T						T						T

T Total selectivity, up to the breaking capacity of the downstream circuit breaker.

4 Selectivity limit = 4 kA.

No selectivity.

**Note:** respect the basic rules of selectivity, in terms of overload, short-circuit, ground fault and earth leakage when applicable see page A-2, or check curves with Schneider Electric online "Electrical calculation tools".

# Selectivity table

Upstream: Masterpact MTZ1 06-16 H2 Micrologic X

Downstream: Compact NS630b-1600 Micrologic A/E/P

Ue ≤ 440 V AC



Upstream		Masterpact MTZ1 06/08/10/12/16 H2																			
Trip unit		Micrologic 2.0X I <sub>sd</sub> = 10I <sub>r</sub>						Micrologic 5.0X - 6.0X - 7.0X Inst : 15 In Standard						Micrologic 5.0X - 6.0X - 7.0X Inst : OFF							
Downstream	Rating (A)	630		800		1000		1250		1600		630		800		1000		1250		1600	
	Setting I <sub>r</sub>	400	630	800	1000	1250	1600	400	630	800	1000	1250	1600	400	630	800	1000	1250	1600		
<b>Selectivity limit (kA)</b>																					
<b>Compact NS630b</b>	250	4	6.3	8	10	12.5	16	9.4	9.4	12	15	18.7	24	42	42	42	42	42	42	42	
	N/H		6.3	8	10	12.5	16		9.4	12	15	18.7	24		42	42	42	42	42	42	
	Micrologic		6.3	8	10	12.5	16		9.4	12	15	18.7	24		42	42	42	42	42	42	
	2.0 - 5.0 - 6.0			8	10	12.5	16			12	15	18.7	24			42	42	42	42	42	
	A/E/P/H				10	12.5	16				15	18.7	24				42	42	42	42	
<b>Compact NS800</b>	320		6.3	8	10	12.5	16		9.4	12	15	18.7	24		42	42	42	42	42	42	
	N/H		6.3	8	10	12.5	16		9.4	12	15	18.7	24		42	42	42	42	42	42	
	Micrologic			8	10	12.5	16			12	15	18.7	24			42	42	42	42	42	
	2.0 - 5.0 - 6.0 - 7.0				10	12.5	16				15	18.7	24			42	42	42	42	42	
	A/E/P/H					12.5	16					18.7	24				42	42	42	42	
<b>Compact NS1000</b>	400		6.3	8	10	12.5	16		9.4	12	15	18.7	24		42	42	42	42	42	42	
	N/H			8	10	12.5	16			12	15	18.7	24		42	42	42	42	42	42	
	Micrologic				10	12.5	16				15	18.7	24			42	42	42	42	42	
	2.0 - 5.0 - 6.0 - 7.0					12.5	16					18.7	24				42	42	42	42	
	A/E/P/H						16						24					42	42	42	
<b>Compact NS1250</b>	500			8	10	12.5	16			12	15	18.7	24			42	42	42	42	42	
	N/H				10	12.5	16				15	18.7	24				42	42	42	42	
	Micrologic					12.5	16					18.7	24					42	42	42	
	2.0 - 5.0 - 6.0 - 7.0						16						24						42	42	
	A/E/P/H																			42	
<b>Compact NS1600</b>	630				10	12.5	16				15	18.7	24				42	42	42	42	
	N/H					12.5	16					18.7	24					42	42	42	
	Micrologic						16						24						42	42	
	2.0 - 5.0 - 6.0 - 7.0																			42	
	A/E/P/H																				
<b>Compact NS630b</b>	250	4	6.3	8	T	T	T	T	T	T	T	T	T	T	T	T	T	T	T	T	
	L/LB		6.3	8	T	T	T		T	T	T	T	T		T	T	T	T	T	T	
	Micrologic		6.3	8	T	T	T		T	T	T	T	T		T	T	T	T	T	T	
	2.0 - 5.0 - 6.0 - 7.0			8	T	T	T			T	T	T	T			T	T	T	T	T	
	A/E/P/H				T	T	T				T	T	T				T	T	T	T	
<b>Compact NS800</b>	320		6.3	8	10	T	T		9.4	T	T	T	T		T	T	T	T	T	T	
	L/LB		6.3	8	10	T	T		9.4	T	T	T	T		T	T	T	T	T	T	
	Micrologic			8	10	T	T			T	T	T	T			T	T	T	T	T	
	2.0 - 5.0 - 6.0 - 7.0				10	T	T				T	T	T				T	T	T	T	
	A/E/P/H					T	T					T	T					T	T	T	
<b>Compact NS1000</b>	400		6.3	8	10	12.5	T		9.4	12	T	T	T		T	T	T	T	T	T	
	L			8	10	12.5	T			12	T	T	T			T	T	T	T	T	
	Micrologic				10	12.5	T				T	T	T				T	T	T	T	
	2.0 - 5.0 - 6.0 - 7.0					12.5	T					T	T					T	T	T	
	A/E/P/H						T						T						T	T	

**T** Total selectivity, up to the breaking capacity of the downstream circuit breaker.

**4** Selectivity limit = 4 kA.

No selectivity.

**Note:** respect the basic rules of selectivity, in terms of overload, short-circuit, ground fault and earth leakage when applicable see page A-2, or check curves with Schneider Electric online "Electrical calculation tools".

# Selectivity table

Upstream: Masterpact MTZ1 06-16 H2 Micrologic X

Downstream: Masterpact MTZ1 06-16

Ue ≤ 440 V AC

A

Upstream		Masterpact MTZ1 06/08/10/12/16 H2																	
Trip unit		Micrologic 2.0X Isd = 10Ir						Micrologic 5.0X - 6.0X - 7.0X Inst : 15 In Standard						Micrologic 5.0X - 6.0X - 7.0X Inst : OFF					
Downstream	Rating (A)	630		800	1000	1250	1600	630		800	1000	1250	1600	630		800	1000	1250	1600
	Setting Ir	400	630	800	1000	1250	1600	400	630	800	1000	1250	1600	400	630	800	1000	1250	1600
<b>Selectivity limit (kA)</b>																			
Masterpact MTZ1 06 H1/H2/H3	250	4	6.3	8	10	12.5	16	9.4	9.4	12	15	18.7	24	42	42	42	42	42	42
	320		6.3	8	10	12.5	16		9.4	12	15	18.7	24		42	42	42	42	42
	400		6.3	8	10	12.5	16		9.4	12	15	18.7	24		42	42	42	42	42
	500			8	10	12.5	16			12	15	18.7	24			42	42	42	42
	630				10	12.5	16				15	18.7	24				42	42	42
Masterpact MTZ1 08 H1/H2/H3	320		6.3	8	10	12.5	16		9.4	12	15	18.7	24		42	42	42	42	42
	400		6.3	8	10	12.5	16		9.4	12	15	18.7	24		42	42	42	42	42
	500			8	10	12.5	16			12	15	18.7	24			42	42	42	42
	630				10	12.5	16				15	18.7	24			42	42	42	42
	800					12.5	16					18.7	24				42	42	42
Masterpact MTZ1 10 H1/H2/H3	400		6.3	8	10	12.5	16		9.4	12	15	18.7	24		42	42	42	42	42
	500			8	10	12.5	16			12	15	18.7	24			42	42	42	42
	630				10	12.5	16				15	18.7	24				42	42	42
	800					12.5	16					18.7	24					42	42
	1000						16						24						42
Masterpact MTZ1 12 H1/H2/H3	500			8	10	12.5	16			12	15	18.7	24			42	42	42	42
	630				10	12.5	16				15	18.7	24				42	42	42
	800					12.5	16					18.7	24					42	42
	1000						16						24						42
	1250																		
Masterpact MTZ1 16 H1/H2/H3	630				10	12.5	16				15	18.7	24				42	42	42
	800					12.5	16					18.7	24					42	42
	960						16						24						42
	1250																		
	1600																		
Masterpact MTZ1 06 L1	250	4	6.3	8	T	T	T	T	T	T	T	T	T	T	T	T	T	T	T
	320		6.3	8	T	T	T		T	T	T	T	T		T	T	T	T	T
	400		6.3	8	T	T	T		T	T	T	T	T		T	T	T	T	T
	500			8	T	T	T			T	T	T	T			T	T	T	T
	630				T	T	T				T	T	T				T	T	T
Masterpact MTZ1 08 L1	320		6.3	8	10	T	T		9.4	T	T	T	T		T	T	T	T	T
	400		6.3	8	10	T	T		9.4	T	T	T	T		T	T	T	T	T
	500			8	10	T	T			T	T	T	T			T	T	T	T
	630				10	T	T				T	T	T				T	T	T
	800					T	T					T	T					T	T
Masterpact MTZ1 10 L1	400		6.3	8	10	12.5	T		9.4	12	T	T	T		T	T	T	T	T
	500			8	10	12.5	T			12	T	T	T			T	T	T	T
	630				10	12.5	T				T	T	T				T	T	T
	800					12.5	T					T	T					T	T
	1000						T						T						T

**T** Total selectivity, up to the breaking capacity of the downstream circuit breaker.

**4** Selectivity limit = 4 kA.

No selectivity.

**Note:** respect the basic rules of selectivity, in terms of overload, short-circuit, ground fault and earth leakage when applicable see page A-2, or check curves with Schneider Electric online "Electrical calculation tools".

# Selectivity table

Upstream: Masterpact MTZ1 06-16 H3 Micrologic X

Downstream: Compact NS630b-1600 Micrologic A/E/P

Ue ≤ 440 V AC



Upstream		Masterpact MTZ1 06/08/10/12/16 H3																			
Trip unit		Micrologic 2.0X I <sub>sd</sub> = 10I <sub>r</sub>						Micrologic 5.0X - 6.0X - 7.0X Inst : 15 In Standard						Micrologic 5.0X - 6.0X - 7.0X Inst : OFF							
Downstream	Rating (A)	630		800		1000		1250		1600		630		800		1000		1250		1600	
	Setting I <sub>r</sub>	400	630	800	1000	1250	1600	400	630	800	1000	1250	1600	400	630	800	1000	1250	1600		
<b>Selectivity limit (kA)</b>																					
<b>Compact NS630b</b>	<b>250</b>	4	6.3	8	10	12.5	16	9.4	9.4	12	15	18.7	24	50	50	50	50	50	50	50	
<b>N/H</b>	<b>320</b>		6.3	8	10	12.5	16		9.4	12	15	18.7	24		50	50	50	50	50	50	
Micrologic	400		6.3	8	10	12.5	16		9.4	12	15	18.7	24		50	50	50	50	50	50	
2.0 - 5.0 - 6.0 - 7.0	500			8	10	12.5	16			12	15	18.7	24			50	50	50	50	50	
A/E/P	630				10	12.5	16				15	18.7	24				50	50	50	50	
<b>Compact NS800</b>	<b>320</b>		6.3	8	10	12.5	16		9.4	12	15	18.7	24		50	50	50	50	50	50	
<b>N/H</b>	<b>400</b>		6.3	8	10	12.5	16		9.4	12	15	18.7	24		50	50	50	50	50	50	
Micrologic	500			8	10	12.5	16			12	15	18.7	24			50	50	50	50	50	
2.0 - 5.0 - 6.0 - 7.0	630				10	12.5	16				15	18.7	24				50	50	50	50	
A/E/P	800					12.5	16					18.7	24					50	50	50	
<b>Compact NS1000</b>	<b>400</b>		6.3	8	10	12.5	16		9.4	12	15	18.7	24		50	50	50	50	50	50	
<b>N/H</b>	<b>500</b>			8	10	12.5	16			12	15	18.7	24			50	50	50	50	50	
Micrologic	630				10	12.5	16				15	18.7	24				50	50	50	50	
2.0 - 5.0 - 6.0 - 7.0	800					12.5	16					18.7	24					50	50	50	
A/E/P	1000						16						24						50	50	
<b>Compact NS1250</b>	<b>500</b>			8	10	12.5	16			12	15	18.7	24			50	50	50	50	50	
<b>N/H</b>	<b>630</b>				10	12.5	16				15	18.7	24				50	50	50	50	
Micrologic	800					12.5	16					18.7	24					50	50	50	
2.0 - 5.0 - 6.0 - 7.0	1000						16						24						50	50	
A/E/P	1250																			50	
<b>Compact NS1600</b>	<b>630</b>				10	12.5	16				15	18.7	24					50	50	50	
<b>N/H</b>	<b>800</b>					12.5	16					18.7	24						50	50	
Micrologic	960						16						24							50	
2.0 - 5.0 - 6.0 - 7.0	1250																				
A/E/P	1600																				
<b>Compact NS630b</b>	<b>250</b>	4	6.3	8	T	T	T	T	T	T	T	T	T	T	T	T	T	T	T	T	
<b>L/LB</b>	<b>320</b>		6.3	8	T	T	T		T	T	T	T	T		T	T	T	T	T	T	
Micrologic	400		6.3	8	T	T	T		T	T	T	T	T		T	T	T	T	T	T	
2.0 - 5.0 - 6.0 - 7.0	500			8	T	T	T			T	T	T	T			T	T	T	T	T	
A/E/P	630				T	T	T				T	T	T				T	T	T	T	
<b>Compact NS800</b>	<b>320</b>		6.3	8	10	T	T		9.4	T	T	T	T		T	T	T	T	T	T	
<b>L/LB</b>	<b>400</b>		6.3	8	10	T	T		9.4	T	T	T	T		T	T	T	T	T	T	
Micrologic	500			8	10	T	T			T	T	T	T			T	T	T	T	T	
2.0 - 5.0 - 6.0 - 7.0	630				10	T	T				T	T	T				T	T	T	T	
A/E/P	800					T	T					T	T					T	T	T	
<b>Compact NS1000</b>	<b>400</b>		6.3	8	10	12.5	T		9.4	12	T	T	T		T	T	T	T	T	T	
<b>L</b>	<b>500</b>			8	10	12.5	T			12	T	T	T			T	T	T	T	T	
Micrologic	630				10	12.5	T				T	T	T				T	T	T	T	
2.0 - 5.0 - 6.0 - 7.0	800					12.5	T					T	T					T	T	T	
A/E/P	1000						T						T						T	T	

**T** Total selectivity, up to the breaking capacity of the downstream circuit breaker.

**4** Selectivity limit = 4 kA.

No selectivity.

**Note:** respect the basic rules of selectivity, in terms of overload, short-circuit, ground fault and earth leakage when applicable see page A-2, or check curves with Schneider Electric online "Electrical calculation tools".

# Selectivity table

Upstream: Masterpact MTZ1 06-16 H3 Micrologic X

Downstream: Masterpact MTZ1 06-16

Ue ≤ 440 V AC

A

Upstream		Masterpact MTZ1 06/08/10/12/16 H3																			
Trip unit		Micrologic 2.0X Isd = 10Ir						Micrologic 5.0X - 6.0X - 7.0X Inst : 15 In Standard						Micrologic 5.0X - 6.0X - 7.0X Inst : OFF							
Downstream	Rating (A)	630		800		1000		1250		1600		630		800		1000		1250		1600	
	Setting Ir	400	630	800	1000	1250	1600	400	630	800	1000	1250	1600	400	630	800	1000	1250	1600		
<b>Selectivity limit (kA)</b>																					
<b>Masterpact MTZ1 06 H1/H2/H3</b>	250	4	6.3	8	10	12.5	16	9.4	9.4	12	15	18.7	24	50	50	50	50	50	50	50	
	320		6.3	8	10	12.5	16		9.4	12	15	18.7	24		50	50	50	50	50	50	
	400		6.3	8	10	12.5	16		9.4	12	15	18.7	24		50	50	50	50	50	50	
	500			8	10	12.5	16			12	15	18.7	24			50	50	50	50	50	
	630				10	12.5	16				15	18.7	24				50	50	50	50	
<b>Masterpact MTZ1 08 H1/H2/H3</b>	320		6.3	8	10	12.5	16		9.4	12	15	18.7	24		50	50	50	50	50	50	
	400		6.3	8	10	12.5	16		9.4	12	15	18.7	24		50	50	50	50	50	50	
	500			8	10	12.5	16			12	15	18.7	24			50	50	50	50	50	
	630				10	12.5	16				15	18.7	24			50	50	50	50	50	
	800					12.5	16					18.7	24				50	50	50	50	
<b>Masterpact MTZ1 10 H1/H2/H3</b>	400		6.3	8	10	12.5	16		9.4	12	15	18.7	24		50	50	50	50	50	50	
	500			8	10	12.5	16			12	15	18.7	24		50	50	50	50	50	50	
	630				10	12.5	16				15	18.7	24			50	50	50	50		
	800					12.5	16					18.7	24				50	50	50		
	1000						16						24					50	50		
<b>Masterpact MTZ1 12 H1/H2/H3</b>	500			8	10	12.5	16			12	15	18.7	24		50	50	50	50	50		
	630				10	12.5	16				15	18.7	24			50	50	50	50		
	800					12.5	16					18.7	24				50	50			
	1000						16						24					50			
	1250																				
<b>Masterpact MTZ1 16 H1/H2/H3</b>	630				10	12.5	16				15	18.7	24			50	50	50			
	800					12.5	16					18.7	24				50	50			
	960						16						24					50			
	1250																				
	1600																				
<b>Masterpact MTZ1 06 L1</b>	250	4	6.3	8	T	T	T	T	T	T	T	T	T	T	T	T	T	T	T	T	
	320		6.3	8	T	T	T		T	T	T	T	T		T	T	T	T	T		
	400		6.3	8	T	T	T		T	T	T	T	T		T	T	T	T	T		
	500			8	T	T	T			T	T	T	T			T	T	T	T		
	630				T	T	T				T	T	T				T	T			
<b>Masterpact MTZ1 08 L1</b>	320		6.3	8	10	T	T		9.4	T	T	T	T		T	T	T	T	T		
	400		6.3	8	10	T	T		9.4	T	T	T	T		T	T	T	T	T		
	500			8	10	T	T			T	T	T	T			T	T	T	T		
	630				10	T	T				T	T	T				T	T			
	800					T	T					T	T					T			
<b>Masterpact MTZ1 10 L1</b>	400		6.3	8	10	12.5	T		9.4	12	T	T	T		T	T	T	T	T		
	500			8	10	12.5	T			12	T	T	T			T	T	T	T		
	630				10	12.5	T				T	T	T				T	T			
	800					12.5	T					T	T					T			
	1000						T						T								

**T** Total selectivity, up to the breaking capacity of the downstream circuit breaker.

**4** Selectivity limit = 4 kA.

No selectivity.

**Note:** respect the basic rules of selectivity, in terms of overload, short-circuit, ground fault and earth leakage when applicable see page A-2, or check curves with Schneider Electric online "Electrical calculation tools".

# Selectivity table

Upstream: Masterpact MTZ1 06-10 L1 Micrologic X

Downstream: iDPN, iC40, iC60, C120, NG125, Compact NSXm, NSX100-630

Ue ≤ 440 V AC



Upstream		Masterpact MTZ1 06/08/10 L1														
Trip unit		Micrologic 2.0X Isd = 10Ir					Micrologic 5.0X - 6.0X - 7.0X Inst : 15 In Standard					Micrologic 5.0X - 6.0X - 7.0X Inst : OFF				
Downstream	Rating (A)	630			800	1000	630			800	1000	630			800	1000
	Setting Ir	250	400	630	800	1000	250	400	630	800	1000	250	400	630	800	1000
Selectivity limit (kA)																
iDPN, iDPNN		T	T	T	T	T	T	T	T	T	T	T	T	T	T	T
iC40, iC40N		T	T	T	T	T	T	T	T	T	T	T	T	T	T	T
iC60		T	T	T	T	T	T	T	T	T	T	T	T	T	T	T
C120N/H		T	T	T	T	T	T	T	T	T	T	T	T	T	T	T
NG125N/H		T	T	T	T	T	T	T	T	T	T	T	T	T	T	T
NG125L		T	T	T	T	T	T	T	T	T	T	T	T	T	T	T
Compact NSXm E/B/F/N/H		T	T	T	T	T	T	T	T	T	T	T	T	T	T	T
Compact NSX100 B/FN/H/S/L/R TM-D		T	T	T	T	T	T	T	T	T	T	T	T	T	T	T
Compact NSX160 B/F TM-D		T	T	T	T	T	T	T	T	T	T	T	T	T	T	T
Compact NSX160 N/H/S/L TM-D		36	36	36	T	T	36	36	36	T	T	36	36	36	T	T
Compact NSX250 B/F/N/H/S/L/R TM-D	≤ 125	20	20	20	T	T	20	20	20	T	T	20	20	20	T	T
	160	20	20	20	T	T	20	20	20	T	T	20	20	20	T	T
	200		20	20	T	T		20	20	T	T		20	20	T	T
	250		20	20	T	T		20	20	T	T		20	20	T	T
Compact NSX100 B/F/N/H/S/L/R Micrologic	40	T	T	T	T	T	T	T	T	T	T	T	T	T	T	T
	100	T	T	T	T	T	T	T	T	T	T	T	T	T	T	T
Compact NSX160 B/F Micrologic	40	T	T	T	T	T	T	T	T	T	T	T	T	T	T	T
	100	T	T	T	T	T	T	T	T	T	T	T	T	T	T	T
	160	T	T	T	T	T	T	T	T	T	T	T	T	T	T	T
Compact NSX160 N/H/S/L Micrologic	40	36	36	36	T	T	36	36	36	T	T	36	36	36	T	T
	100	36	36	36	T	T	36	36	36	T	T	36	36	36	T	T
	160	36	36	36	T	T	36	36	36	T	T	36	36	36	T	T
Compact NSX250 B/F/N/H/S/L/R Micrologic	≤ 100	20	20	20	T	T	20	20	20	T	T	20	20	20	T	T
	160		20	20	T	T		20	20	T	T		20	20	T	T
	250		20	20	T	T		20	20	T	T		20	20	T	T
Compact NSX400 F/N/H/S/L/R Micrologic	160	6.3	6.3	6.3	10	15	6.3	6.3	6.3	10	15	6.3	6.3	6.3	10	15
	200		6.3	6.3	10	15		6.3	6.3	10	15		6.3	6.3	10	15
	250		6.3	6.3	10	15		6.3	6.3	10	15		6.3	6.3	10	15
	320		6.3	6.3	10	15			6.3	10	15			6.3	10	15
	400			6.3	10	15			6.3	10	15			6.3	10	15
Compact NSX630 F/N/H/S/L/R Micrologic	250		6.3	6.3	8	10		6.3	6.3	8	10		6.3	6.3	8	10
	320			6.3	8	10			6.3	8	10			6.3	8	10
	400			6.3	8	10			6.3	8	10			6.3	8	10
	500				8	10				8	10				8	10
	630					10					10					10

**T** Total selectivity, up to the breaking capacity of the downstream circuit breaker.

**4** Selectivity limit = 4 kA.

No selectivity.

**Note:** respect the basic rules of selectivity, in terms of overload, short-circuit, ground fault and earth leakage when applicable see page A-2, or check curves with Schneider Electric online "Electrical calculation tools".

# Selectivity table

Upstream: Masterpact MTZ1 06-10 L1 Micrologic X

Downstream: Compact NS630b-1000, Masterpact MTZ1 06-10

A
 Ue ≤ 440 V AC

Upstream		Masterpact MTZ1 06/08/10 L1															
Trip unit		Micrologic 2.0X I <sub>sd</sub> = 10I <sub>r</sub>						Micrologic 5.0X - 6.0X - 7.0X Inst : 15 in Standard						Micrologic 5.0X - 6.0X - 7.0X Inst : OFF			
Downstream	Rating (A)	630			800	1000	630			800	1000	630			800	1000	
	Setting I <sub>r</sub>	250	400	630	800	1000	250	400	630	800	1000	250	400	630	800	1000	
<b>Selectivity limit (kA)</b>																	
<b>Compact NS630b</b> N/H/L/LB Micrologic 2.0 - 5.0 - 6.0 - 7.0 A/E/P	250		6.3	6.3	8	10		6.3	6.3	8	10		6.3	6.3	8	10	
	320			6.3	8	10			6.3	8	10			6.3	8	10	
	400			6.3	8	10			6.3	8	10			6.3	8	10	
	500				8	10				8	10				8	10	
	630					10					10					10	
<b>Compact NS800</b> N/H/L/LB Micrologic 2.0 - 5.0 - 6.0 - 7.0 A/E/P	320			6.3	8	10			6.3	8	10			6.3	8	10	
	400			6.3	8	10			6.3	8	10			6.3	8	10	
	500				8	10				8	10				8	10	
	630					10					10					10	
	800																
<b>Compact NS1000</b> N/H/L Micrologic 2.0 - 5.0 - 6.0 - 7.0 A/E/P	400					10					10			6.3	10	10	
	500					10					10			10	10		
	630					10					10				10		
	800																
	1000																
<b>Masterpact MTZ1 06</b> H1/H2/H3/L1 Micrologic 2.0 - 5.0 - 6.0 - 7.0 X	250		6.3	6.3	8	10		6.3	6.3	8	10		6.3	6.3	8	10	
	320			6.3	8	10			6.3	8	10			6.3	8	10	
	400			6.3	8	10			6.3	8	10			6.3	8	10	
	500				8	10				8	10				8	10	
	630					10					10					10	
<b>Masterpact MTZ1 08</b> H1/H2/H3/L1 Micrologic 2.0 - 5.0 - 6.0 - 7.0 X	320			6.3	8	10			6.3	8	10			6.3	8	10	
	400			6.3	8	10			6.3	8	10			6.3	8	10	
	500				8	10				8	10				8	10	
	630					10					10					10	
	800																
<b>Masterpact MTZ1 10</b> H1/H2/H3/L1 Micrologic 2.0 - 5.0 - 6.0 - 7.0 X	400					10					10			6.3	10	10	
	500					10					10			10	10		
	630					10					10				10		
	800																
	1000																

 Selectivity limit = 4 kA.

 No selectivity.

**Note:** respect the basic rules of selectivity, in terms of overload, short-circuit, ground fault and earth leakage when applicable see page A-2, or check curves with Schneider Electric online "Electrical calculation tools".



# Selectivity table

Upstream: Masterpact MTZ2 08-20 N1/H1/H2/L1 Micrologic X

Downstream: iDPN, iC40, iC60, C120, NG125, Compact NSXm, NSX100-630

Ue ≤ 440 V AC



Upstream		Masterpact MTZ2 08/10/12/16/20 N1/H1/H2/L1																			
Trip unit		Micrologic 2.0X Isd = 10Ir						Micrologic 5.0X - 6.0X - 7.0X Inst : 15 in Standard						Micrologic 5.0X - 6.0X - 7.0X Inst : OFF							
Downstream	Rating (A)	800		1000		1250		1600		2000		800		1000		1250		1600		2000	
	Setting Ir	320	630	800	1000	1250	1600	2000	320	630	800	1000	1250	1600	2000	320	630	800	1000	1250	1600
Selectivity limit (kA)																					
iDPN, iDPNN		T	T	T	T	T	T	T	T	T	T	T	T	T	T	T	T	T	T	T	T
iC40, iC40N		T	T	T	T	T	T	T	T	T	T	T	T	T	T	T	T	T	T	T	T
iC60		T	T	T	T	T	T	T	T	T	T	T	T	T	T	T	T	T	T	T	T
C120N/H		T	T	T	T	T	T	T	T	T	T	T	T	T	T	T	T	T	T	T	T
NG125N/H		T	T	T	T	T	T	T	T	T	T	T	T	T	T	T	T	T	T	T	T
NG125L		T	T	T	T	T	T	T	T	T	T	T	T	T	T	T	T	T	T	T	T
Compact NSXm E/B/F/N/H		T	T	T	T	T	T	T	T	T	T	T	T	T	T	T	T	T	T	T	T
Compact NSX100 B/F/N/H/S/L/R TM-D		T	T	T	T	T	T	T	T	T	T	T	T	T	T	T	T	T	T	T	T
Compact NSX160 B/F/N/H/S/L TM-D		T	T	T	T	T	T	T	T	T	T	T	T	T	T	T	T	T	T	T	T
Compact NSX250 ≤ 125		T	T	T	T	T	T	T	T	T	T	T	T	T	T	T	T	T	T	T	T
B/F/N/H/S/L/R		160	T	T	T	T	T	T	T	T	T	T	T	T	T	T	T	T	T	T	T
TM-D		200	T	T	T	T	T	T	T	T	T	T	T	T	T	T	T	T	T	T	T
		250		T	T	T	T	T		T	T	T	T	T		T	T	T	T	T	T
Compact NSX100 B/F/N/H/S/L/R		40	T	T	T	T	T	T	T	T	T	T	T	T	T	T	T	T	T	T	T
Micrologic		100	T	T	T	T	T	T	T	T	T	T	T	T	T	T	T	T	T	T	T
Compact NSX160 B/F/N/H/S/L		40	T	T	T	T	T	T	T	T	T	T	T	T	T	T	T	T	T	T	T
Micrologic		100	T	T	T	T	T	T	T	T	T	T	T	T	T	T	T	T	T	T	T
		160	T	T	T	T	T	T	T	T	T	T	T	T	T	T	T	T	T	T	T
Compact NSX250 ≤ 100		100	T	T	T	T	T	T	T	T	T	T	T	T	T	T	T	T	T	T	T
B/F/N/H/S/L/R		160	T	T	T	T	T	T	T	T	T	T	T	T	T	T	T	T	T	T	T
Micrologic		250		T	T	T	T	T		T	T	T	T	T		T	T	T	T	T	T
Compact NSX400 F/N/H/S/L/R		160	T	T	T	T	T	T	T	T	T	T	T	T	T	T	T	T	T	T	T
Micrologic		200	T	T	T	T	T	T	T	T	T	T	T	T	T	T	T	T	T	T	T
		250	T	T	T	T	T	T	T	T	T	T	T	T	T	T	T	T	T	T	T
		320		T	T	T	T	T		T	T	T	T	T		T	T	T	T	T	T
		400		T	T	T	T	T		T	T	T	T	T		T	T	T	T	T	T
Compact NSX630 F/N/H/S/L/R		250	T	T	T	T	T	T	T	T	T	T	T	T	T	T	T	T	T	T	T
Micrologic		320		T	T	T	T	T		T	T	T	T	T		T	T	T	T	T	T
		400		T	T	T	T	T		T	T	T	T	T		T	T	T	T	T	T
		500			T	T	T	T			T	T	T	T			T	T	T	T	T
		630				T	T	T				T	T	T				T	T	T	T

**T** Total selectivity, up to the breaking capacity of the downstream circuit breaker.

□ No selectivity.

**Note:** respect the basic rules of selectivity, in terms of overload, short-circuit, ground fault and earth leakage when applicable see page A-2, or check curves with Schneider Electric online "Electrical calculation tools".

# Selectivity table

Upstream: Masterpact MTZ2 08-20 N1/H1/H2 Micrologic X

Downstream: Compact NS630b-1600 Micrologic A/E/P

Ue ≤ 440 V AC

A

Upstream		Masterpact MTZ2 08/10/12/16/20 N1/H1/H2																			
Trip unit		Micrologic 2.0X Isd = 10Ir						Micrologic 5.0X - 6.0X - 7.0X Inst : 15 In Standard						Micrologic 5.0X - 6.0X - 7.0X Inst : OFF							
Downstream	Rating (A)	800		1000		1250		1600		2000		800		1000		1250		1600		2000	
	Setting Ir	630	800	1000	1250	1600	2000	630	800	1000	1250	1600	2000	630	800	1000	1250	1600	2000		
<b>Selectivity limit (kA)</b>																					
Compact NS630bN/H	250	6.3	8	10	12.5	16	20	12	12	15	18.75	24	30	T	T	T	T	T	T	T	
	320	6.3	8	10	12.5	16	20	12	12	15	18.75	24	30	T	T	T	T	T	T	T	
	Micrologic	6.3	8	10	12.5	16	20	12	12	15	18.75	24	30	T	T	T	T	T	T	T	
	2.0 - 5.0 - 6.0 - 7.0 A/E/P	500	8	10	12.5	16	20	12	15	18.75	24	30		T	T	T	T	T	T	T	
	630		10	12.5	16	20		15	18.75	24	30			T	T	T	T	T	T		
Compact NS800N/H	320	6.3	8	10	12.5	16	20	12	12	15	18.75	24	30	T	T	T	T	T	T	T	
	400	6.3	8	10	12.5	16	20	12	12	15	18.75	24	30	T	T	T	T	T	T	T	
	Micrologic		8	10	12.5	16	20		12	15	18.75	24	30		T	T	T	T	T	T	
	2.0 - 5.0 - 6.0 - 7.0 A/E/P	500		10	12.5	16	20		15	18.75	24	30			T	T	T	T	T	T	
	630			10	12.5	16	20			18.75	24	30				T	T	T	T		
	800				12.5	16	20				18.75	24	30				T	T	T		
Compact NS1000N/H	400	6.3	8	10	12.5	16	20	12	12	15	18.75	24	30	T	T	T	T	T	T	T	
	500		8	10	12.5	16	20		12	15	18.75	24	30		T	T	T	T	T	T	
	Micrologic			10	12.5	16	20			15	18.75	24	30			T	T	T	T	T	
	2.0 - 5.0 - 6.0 - 7.0 A/E/P	630			12.5	16	20				18.75	24	30				T	T	T	T	
	800				16	20					24	30					T	T	T		
	1000					20						30						T	T		
Compact NS1250N/H	500		8	10	12.5	16	20		12	15	18.75	24	30		T	T	T	T	T	T	
	630			10	12.5	16	20			15	18.75	24	30			T	T	T	T	T	
	Micrologic				12.5	16	20				18.75	24	30				T	T	T	T	
	2.0 - 5.0 - 6.0 - 7.0 A/E/P	800				16	20					24	30					T	T	T	
	1000					20						30							T		
Compact NS1600N/H	630			10	12.5	16	20			15	18.75	24	30			T	T	T	T	T	
	800				12.5	16	20				18.75	24	30				T	T	T	T	
	Micrologic				16	20						24	30					T	T	T	
	2.0 - 5.0 - 6.0 - 7.0 A/E/P	960				20							30							T	
	1250					20							30							T	
	1600																			T	
Compact NS630bL/LB	250	6.3	8	T	T	T	T	T	T	T	T	T	T	T	T	T	T	T	T	T	
	320	6.3	8	T	T	T	T	T	T	T	T	T	T	T	T	T	T	T	T	T	
	Micrologic	6.3	8	T	T	T	T	T	T	T	T	T	T	T	T	T	T	T	T	T	
	2.0 - 5.0 - 6.0 - 7.0 A/E/P	400	8	T	T	T	T		T	T	T	T	T	T	T	T	T	T	T	T	
	500	8	T	T	T	T		T	T	T	T	T	T	T	T	T	T	T	T		
	630		T	T	T	T		T	T	T	T	T	T	T	T	T	T	T	T		
Compact NS800 L/LB	320	6.3	8	10	T	T	T	T	T	T	T	T	T	T	T	T	T	T	T	T	
	400	6.3	8	10	T	T	T	T	T	T	T	T	T	T	T	T	T	T	T	T	
	Micrologic		8	10	T	T	T		T	T	T	T	T	T	T	T	T	T	T	T	
	2.0 - 5.0 - 6.0 - 7.0 A/E/P	500		10	T	T	T		T	T	T	T	T	T	T	T	T	T	T	T	
	630			10	T	T	T		T	T	T	T	T	T	T	T	T	T	T		
	800				T	T	T			T	T	T	T	T	T	T	T	T	T		
Compact NS1000L	400	6.3	8	10	12.5	T	T	12	12	T	T	T	T	T	T	T	T	T	T	T	
	500		8	10	12.5	T	T		12	T	T	T	T		T	T	T	T	T	T	
	Micrologic			10	12.5	T	T			T	T	T	T			T	T	T	T	T	
	2.0 - 5.0 - 6.0 - 7.0 A/E/P	630			12.5	T	T				T	T	T				T	T	T	T	
	800				T	T					T	T	T					T	T		
	1000					T	T					T	T						T		

**T** Total selectivity, up to the breaking capacity of the downstream circuit breaker.

**4** Selectivity limit = 4 kA.

No selectivity.

**Note:** respect the basic rules of selectivity, in terms of overload, short-circuit, ground fault and earth leakage when applicable see page A-2, or check curves with Schneider Electric online "Electrical calculation tools".

# Selectivity table

Upstream: Masterpact MTZ2 08-20 N1/H1/H2 Micrologic X

Downstream: Masterpact MTZ1 06-16

Ue ≤ 440 V AC



Upstream		Masterpact MTZ2 08/10/12/16/20 N1/H1/H2																			
Trip unit		Micrologic 2.0X Isd = 10Ir						Micrologic 5.0X - 6.0X - 7.0X Inst : 15 In Standard						Micrologic 5.0X - 6.0X - 7.0X Inst : OFF							
Downstream Rating (A)	Setting Ir	800		1000		1250		1600		2000		800		1000		1250		1600		2000	
		630	800	1000	1250	1600	2000	630	800	1000	1250	1600	2000	630	800	1000	1250	1600	2000		
<b>Selectivity limit (kA)</b>																					
Masterpact MTZ1 06 H1/H2/H3 Micrologic 2.0 - 5.0 - 6.0 - 7.0 X	250	6.3	8	10	12.5	16	20	12	12	15	18.75	24	30	T	T	T	T	T	T	T	
	320	6.3	8	10	12.5	16	20	12	12	15	18.75	24	30	T	T	T	T	T	T	T	
	400	6.3	8	10	12.5	16	20	12	12	15	18.75	24	30	T	T	T	T	T	T	T	
	500		8	10	12.5	16	20		12	15	18.75	24	30		T	T	T	T	T	T	
	630			10	12.5	16	20			15	18.75	24	30			T	T	T	T	T	
Masterpact MTZ1 08 H1/H2/H3 Micrologic 2.0 - 5.0 - 6.0 - 7.0 X	320	6.3	8	10	12.5	16	20	12	12	15	18.75	24	30	T	T	T	T	T	T	T	
	400	6.3	8	10	12.5	16	20	12	12	15	18.75	24	30	T	T	T	T	T	T	T	
	500		8	10	12.5	16	20		12	15	18.75	24	30		T	T	T	T	T	T	
	630			10	12.5	16	20			15	18.75	24	30			T	T	T	T	T	
	800				12.5	16	20				18.75	24	30				T	T	T	T	
Masterpact MTZ1 10 H1/H2/H3 Micrologic 2.0 - 5.0 - 6.0 - 7.0 X	400	6.3	8	10	12.5	16	20	12	12	15	18.75	24	30	T	T	T	T	T	T	T	
	500		8	10	12.5	16	20		12	15	18.75	24	30		T	T	T	T	T	T	
	630			10	12.5	16	20			15	18.75	24	30			T	T	T	T	T	
	800				12.5	16	20				18.75	24	30				T	T	T	T	
	1000					16	20					24	30					T	T	T	
Masterpact MTZ1 12 H1/H2/H3 Micrologic 2.0 - 5.0 - 6.0 - 7.0 X	500		8	10	12.5	16	20		12	15	18.75	24	30		T	T	T	T	T	T	
	630			10	12.5	16	20			15	18.75	24	30			T	T	T	T	T	
	800				12.5	16	20				18.75	24	30				T	T	T	T	
	1000					16	20					24	30					T	T	T	
	1250						20						30							T	T
Masterpact MTZ1 16 H1/H2/H3 Micrologic 2.0 - 5.0 - 6.0 - 7.0 X	630			10	12.5	16	20			15	18.75	24	30			T	T	T	T	T	
	800				12.5	16	20				18.75	24	30				T	T	T	T	
	960					16	20					24	30					T	T	T	
	1250						20						30							T	T
	1600																				T
Masterpact MTZ1 06 L1 Micrologic 2.0 - 5.0 - 6.0 - 7.0 X	250	6.3	8	T	T	T	T	T	T	T	T	T	T	T	T	T	T	T	T	T	
	320	6.3	8	T	T	T	T	T	T	T	T	T	T	T	T	T	T	T	T	T	
	400	6.3	8	T	T	T	T	T	T	T	T	T	T	T	T	T	T	T	T	T	
	500		8	T	T	T	T	T	T	T	T	T	T	T	T	T	T	T	T	T	
	630			T	T	T	T			T	T	T	T	T			T	T	T	T	
Masterpact MTZ1 08 L1 Micrologic 2.0 - 5.0 - 6.0 - 7.0 X	320	6.3	8	10	T	T	T	T	T	T	T	T	T	T	T	T	T	T	T	T	
	400	6.3	8	10	T	T	T	T	T	T	T	T	T	T	T	T	T	T	T	T	
	500		8	10	T	T	T	T	T	T	T	T	T	T	T	T	T	T	T	T	
	630			10	T	T	T	T			T	T	T	T			T	T	T	T	
	800				T	T	T	T				T	T	T				T	T	T	
Masterpact MTZ1 10 L1 Micrologic 2.0 - 5.0 - 6.0 - 7.0 X	400	6.3	8	10	12.5	T	T	12	12	T	T	T	T	T	T	T	T	T	T	T	
	500		8	10	12.5	T	T		12	T	T	T	T	T	T	T	T	T	T	T	
	630			10	12.5	T	T			T	T	T	T	T			T	T	T	T	
	800				12.5	T	T				T	T	T	T				T	T	T	
	1000					T	T						T	T					T	T	

- Total selectivity, up to the breaking capacity of the downstream circuit breaker.
- Selectivity limit = 4 kA.
- No selectivity.

Note: respect the basic rules of selectivity, in terms of overload, short-circuit, ground fault and earth leakage when applicable see page A-2, or check curves with Schneider Electric online "Electrical calculation tools".

# Selectivity table

Upstream: Masterpact MTZ2 08-20 N1/H1 Micrologic X

Downstream: Masterpact MTZ2 08-20

Ue ≤ 440 V AC

A

Upstream		Masterpact MTZ2 08/10/12/16/20 N1/H1																			
Trip unit		Micrologic 2.0X I <sub>sd</sub> = 10I <sub>r</sub>						Micrologic 5.0X - 6.0X - 7.0X Inst : 15 I <sub>n</sub> Standard						Micrologic 5.0X - 6.0X - 7.0X Inst : OFF							
Downstream	Rating (A)	800		1000		1250		1600		2000		800		1000		1250		1600		2000	
	Setting I <sub>r</sub>	630	800	1000	1250	1600	2000	630	800	1000	1250	1600	2000	630	800	1000	1250	1600	2000		
<b>Selectivity limit (kA)</b>																					
<b>Masterpact MTZ2 08 N1/H1/L1</b> Micrologic 2.0 - 5.0 - 6.0 - 7.0 X	320	6.3	8	10	12.5	16	20	12	12	15	18.75	24	30	T	T	T	T	T	T	T	
	400	6.3	8	10	12.5	16	20	12	12	15	18.75	24	30	T	T	T	T	T	T	T	
	500		8	10	12.5	16	20		12	15	18.75	24	30		T	T	T	T	T	T	
	630			10	12.5	16	20			15	18.75	24	30			T	T	T	T	T	
<b>Masterpact MTZ2 10 N1/H1/L1</b> Micrologic 2.0 - 5.0 - 6.0 - 7.0 X	400	6.3	8	10	12.5	16	20	12	12	15	18.75	24	30	T	T	T	T	T	T	T	
	500		8	10	12.5	16	20		12	15	18.75	24	30		T	T	T	T	T	T	
	630			10	12.5	16	20			15	18.75	24	30			T	T	T	T	T	
	800				12.5	16	20				18.75	24	30				T	T	T	T	
<b>Masterpact MTZ2 12 N1/H1/L1</b> Micrologic 2.0 - 5.0 - 6.0 - 7.0 X	500		8	10	12.5	16	20		12	15	18.75	24	30		T	T	T	T	T	T	
	630			10	12.5	16	20			15	18.75	24	30			T	T	T	T	T	
	800				12.5	16	20				18.75	24	30				T	T	T	T	
	1000					16	20					24	30					T	T	T	
<b>Masterpact MTZ2 16 N1/H1/L1</b> Micrologic 2.0 - 5.0 - 6.0 - 7.0 X	630			10	12.5	16	20			15	18.75	24	30			T	T	T	T	T	
	800				12.5	16	20				18.75	24	30				T	T	T	T	
	960					16	20					24	30					T	T	T	
	1250						20						30							T	
<b>Masterpact MTZ2 20 N1/H1/L1</b> Micrologic 2.0 - 5.0 - 6.0 - 7.0 X	800				12.5	16	20				18.75	24	30				T	T	T	T	
	1000					16	20					24	30					T	T	T	
	1250						20						30							T	
	1600																				
<b>Masterpact MTZ2 08 H2</b> Micrologic 2.0 - 5.0 - 6.0 - 7.0 X	320	6.3	8	10	12.5	16	20	12	12	15	18.75	24	30	T	T	T	T	T	T	T	
	400	6.3	8	10	12.5	16	20	12	12	15	18.75	24	30	T	T	T	T	T	T	T	
	500		8	10	12.5	16	20		12	15	18.75	24	30		T	T	T	T	T	T	
	630			10	12.5	16	20			15	18.75	24	30			T	T	T	T	T	
<b>Masterpact MTZ2 10 H2</b> Micrologic 2.0 - 5.0 - 6.0 - 7.0 X	400	6.3	8	10	12.5	16	20	12	12	15	18.75	24	30	T	T	T	T	T	T	T	
	500		8	10	12.5	16	20		12	15	18.75	24	30		T	T	T	T	T	T	
	630			10	12.5	16	20			15	18.75	24	30			T	T	T	T	T	
	800				12.5	16	20				18.75	24	30				T	T	T	T	
<b>Masterpact MTZ2 12 H2</b> Micrologic 2.0 - 5.0 - 6.0 - 7.0 X	500		8	10	12.5	16	20		12	15	18.75	24	30		T	T	T	T	T	T	
	630			10	12.5	16	20			15	18.75	24	30			T	T	T	T	T	
	800				12.5	16	20				18.75	24	30				T	T	T	T	
	1000					16	20					24	30					T	T	T	
<b>Masterpact MTZ2 16 H2</b> Micrologic 2.0 - 5.0 - 6.0 - 7.0 X	630			10	12.5	16	20			15	18.75	24	30			T	T	T	T	T	
	800				12.5	16	20				18.75	24	30				T	T	T	T	
	960					16	20					24	30					T	T	T	
	1250						20						30							T	
<b>Masterpact MTZ2 20 H2</b> Micrologic 2.0 - 5.0 - 6.0 - 7.0 X	800				12.5	16	20				18.75	24	30				T	T	T	T	
	1000					16	20					24	30					T	T	T	
	1250						20						30							T	
	1600																				

- T Total selectivity, up to the breaking capacity of the downstream circuit breaker.
- 4 Selectivity limit = 4 kA.
- No selectivity.

**Note:** respect the basic rules of selectivity, in terms of overload, short-circuit, ground fault and earth leakage when applicable see page A-2, or check curves with Schneider Electric online "Electrical calculation tools".

# Selectivity table

Upstream: Masterpact MTZ2 08-20 H2 Micrologic X

Downstream: Masterpact MTZ2 08-20

U<sub>e</sub> ≤ 440 V AC



<b>Upstream</b>	Masterpact MTZ2 08/10/12/16/20 H2															
<b>Trip unit</b>	Micrologic 2.0X I <sub>sd</sub> = 10I <sub>r</sub>						Micrologic 5.0X - 6.0X - 7.0X Inst : 15 In Standard						Micrologic 5.0X - 6.0X - 7.0X Inst : OFF			

Downstream	Rating (A)	800				1000				1250				1600				2000			
		Setting	I <sub>r</sub>	630	800	1000	1250	1600	2000	630	800	1000	1250	1600	2000	630	800	1000	1250	1600	2000
<b>Selectivity limit (kA)</b>																					
<b>Masterpact MTZ2 08</b>	<b>320</b>	6.3	8	10	12.5	16	20	12	12	15	18.75	24	30	T	T	T	T	T	T		
<b>Micrologic 2.0 - 5.0 - 6.0 - 7.0 X</b>	<b>400</b>	6.3	8	10	12.5	16	20	12	12	15	18.75	24	30	T	T	T	T	T	T		
<b>Micrologic 5.0X - 6.0X - 7.0X</b>	<b>500</b>		8	10	12.5	16	20		12	15	18.75	24	30		T	T	T	T	T		
<b>Masterpact MTZ2 10</b>	<b>400</b>	6.3	8	10	12.5	16	20	12	12	15	18.75	24	30	T	T	T	T	T	T		
<b>Micrologic 2.0 - 5.0 - 6.0 - 7.0 X</b>	<b>500</b>		8	10	12.5	16	20		12	15	18.75	24	30		T	T	T	T	T		
<b>Micrologic 5.0X - 6.0X - 7.0X</b>	<b>630</b>			10	12.5	16	20			15	18.75	24	30			T	T	T	T		
<b>Masterpact MTZ2 12</b>	<b>500</b>		8	10	12.5	16	20		12	15	18.75	24	30		T	T	T	T	T		
<b>Micrologic 2.0 - 5.0 - 6.0 - 7.0 X</b>	<b>630</b>			10	12.5	16	20			15	18.75	24	30			T	T	T	T		
<b>Micrologic 5.0X - 6.0X - 7.0X</b>	<b>800</b>				12.5	16	20				18.75	24	30				T	T	T		
<b>Masterpact MTZ2 16</b>	<b>630</b>			10	12.5	16	20			15	18.75	24	30			T	T	T	T		
<b>Micrologic 2.0 - 5.0 - 6.0 - 7.0 X</b>	<b>800</b>				12.5	16	20				18.75	24	30				T	T	T		
<b>Micrologic 5.0X - 6.0X - 7.0X</b>	<b>960</b>					16	20					24	30					T	T		
<b>Masterpact MTZ2 20</b>	<b>800</b>				12.5	16	20				18.75	24	30				T	T	T		
<b>Micrologic 2.0 - 5.0 - 6.0 - 7.0 X</b>	<b>1000</b>					16	20					24	30					T	T		
<b>Micrologic 5.0X - 6.0X - 7.0X</b>	<b>1250</b>						20						30						T		
<b>Masterpact MTZ2 08 H2</b>	<b>320</b>	6.3	8	10	12.5	16	20	12	12	15	18.75	24	30	82	82	82	82	82	82		
<b>Micrologic 2.0 - 5.0 - 6.0 - 7.0 X</b>	<b>400</b>	6.3	8	10	12.5	16	20	12	12	15	18.75	24	30	82	82	82	82	82	82		
<b>Micrologic 5.0X - 6.0X - 7.0X</b>	<b>500</b>		8	10	12.5	16	20		12	15	18.75	24	30		82	82	82	82	82		
<b>Masterpact MTZ2 10 H2</b>	<b>400</b>	6.3	8	10	12.5	16	20	12	12	15	18.75	24	30	82	82	82	82	82	82		
<b>Micrologic 2.0 - 5.0 - 6.0 - 7.0 X</b>	<b>500</b>		8	10	12.5	16	20		12	15	18.75	24	30		82	82	82	82	82		
<b>Micrologic 5.0X - 6.0X - 7.0X</b>	<b>630</b>			10	12.5	16	20			15	18.75	24	30			82	82	82	82		
<b>Masterpact MTZ2 12 H2</b>	<b>500</b>		8	10	12.5	16	20		12	15	18.75	24	30		82	82	82	82	82		
<b>Micrologic 2.0 - 5.0 - 6.0 - 7.0 X</b>	<b>630</b>			10	12.5	16	20			15	18.75	24	30			82	82	82	82		
<b>Micrologic 5.0X - 6.0X - 7.0X</b>	<b>800</b>				12.5	16	20				18.75	24	30				82	82	82		
<b>Masterpact MTZ2 16 H2</b>	<b>630</b>			10	12.5	16	20			15	18.75	24	30			82	82	82	82		
<b>Micrologic 2.0 - 5.0 - 6.0 - 7.0 X</b>	<b>800</b>				12.5	16	20				18.75	24	30			82	82	82	82		
<b>Micrologic 5.0X - 6.0X - 7.0X</b>	<b>960</b>					16	20					24	30				82	82	82		
<b>Masterpact MTZ2 20 H2</b>	<b>800</b>				12.5	16	20				18.75	24	30				82	82	82		
<b>Micrologic 2.0 - 5.0 - 6.0 - 7.0 X</b>	<b>1000</b>					16	20					24	30				82	82	82		
<b>Micrologic 5.0X - 6.0X - 7.0X</b>	<b>1250</b>						20						30					82	82		
<b>Micrologic 5.0X - 6.0X - 7.0X</b>	<b>1600</b>																		82		

**T** Total selectivity, up to the breaking capacity of the downstream circuit breaker.

**4** Selectivity limit = 4 kA.

□ No selectivity.

**Note:** respect the basic rules of selectivity, in terms of overload, short-circuit, ground fault and earth leakage when applicable see page A-2, or check curves with Schneider Electric online "Electrical calculation tools".

# Selectivity table

Upstream: Masterpact MTZ2 08-20 L1 Micrologic X

Downstream: Masterpact MTZ1 06 - 16 Micrologic X

Ue ≤ 440 V AC

A

Upstream		Masterpact MTZ2 08/10/12/16/20 L1																			
Trip unit		Micrologic 2.0X Isd = 10Ir						Micrologic 5.0X - 6.0X - 7.0X Inst : 15 In Standard						Micrologic 5.0X - 6.0X - 7.0X Inst : OFF							
Downstream	Rating (A)	800		1000		1250		1600		2000		800		1000		1250		1600		2000	
	Setting Ir	630	800	1000	1250	1600	2000	630	800	1000	1250	1600	2000	630	800	1000	1250	1600	2000		
<b>Selectivity limit (kA)</b>																					
Masterpact MTZ1 06 H1/H2/H3 Micrologic X	250	6.3	8	10	12.5	16	20	12	12	15	18.75	24	30	37	37	37	37	37	37	37	
	320	6.3	8	10	12.5	16	20	12	12	15	18.75	24	30	37	37	37	37	37	37	37	
	400	6.3	8	10	12.5	16	20	12	12	15	18.75	24	30	37	37	37	37	37	37	37	
	500		8	10	12.5	16	20		12	15	18.75	24	30		37	37	37	37	37	37	
	630			10	12.5	16	20			15	18.75	24	30			37	37	37	37	37	
Masterpact MTZ1 08 H1/H2/H3 Micrologic X	320	6.3	8	10	12.5	16	20	12	12	15	18.75	24	30	37	37	37	37	37	37	37	
	400	6.3	8	10	12.5	16	20	12	12	15	18.75	24	30	37	37	37	37	37	37	37	
	500		8	10	12.5	16	20		12	15	18.75	24	30		37	37	37	37	37	37	
	630			10	12.5	16	20			15	18.75	24	30			37	37	37	37	37	
	800				12.5	16	20				18.75	24	30				37	37	37	37	
Masterpact MTZ1 10 H1/H2/H3 Micrologic X	400	6.3	8	10	12.5	16	20	12	12	15	18.75	24	30	37	37	37	37	37	37	37	
	500		8	10	12.5	16	20		12	15	18.75	24	30		37	37	37	37	37		
	630			10	12.5	16	20			15	18.75	24	30			37	37	37	37		
	800				12.5	16	20				18.75	24	30				37	37	37		
	1000					16	20					24	30					37	37		
Masterpact MTZ1 12 H1/H2/H3 Micrologic X	500		8	10	12.5	16	20		12	15	18.75	24	30		37	37	37	37	37		
	630			10	12.5	16	20			15	18.75	24	30			37	37	37	37		
	800				12.5	16	20				18.75	24	30				37	37	37		
	1000					16	20					24	30					37	37		
	1250						20						30						37		
Masterpact MTZ1 16 H1/H2/H3 Micrologic X	630			10	12.5	16	20			15	18.75	24	30			37	37	37	37		
	800				12.5	16	20				18.75	24	30				37	37	37		
	960					16	20					24	30					37	37		
	1250						20						30						37		
	1600																				
Masterpact MTZ1 06 L1 Micrologic X	250	6.3	8	10	T	T	T	T	T	T	T	T	T	T	T	T	T	T	T		
	320	6.3	8	10	T	T	T	T	T	T	T	T	T	T	T	T	T	T	T		
	400	6.3	8	10	T	T	T	T	T	T	T	T	T	T	T	T	T	T	T		
	500		8	10	T	T	T		T	T	T	T	T		T	T	T	T	T		
	630			10	T	T	T			T	T	T	T			T	T	T	T		
Masterpact MTZ1 08 L1 Micrologic X	320	6.3	8	10	12.5	T	T	12	12	T	T	T	T	T	T	T	T	T	T		
	400	6.3	8	10	12.5	T	T	12	12	T	T	T	T	T	T	T	T	T	T		
	500		8	10	12.5	T	T		12	T	T	T	T		T	T	T	T	T		
	630			10	12.5	T	T			T	T	T	T			T	T	T	T		
	800				12.5	T	T				T	T	T				T	T	T		
Masterpact MTZ1 10 L1 Micrologic X	400	6.3	8	10	12.5	T	T	12	12	T	T	T	T	T	T	T	T	T	T		
	500		8	10	12.5	T	T		12	T	T	T	T		T	T	T	T	T		
	630			10	12.5	T	T			T	T	T	T			T	T	T	T		
	800				12.5	T	T				T	T	T				T	T	T		
	1000					T	T					T	T					T	T		

**T** Total selectivity, up to the breaking capacity of the downstream circuit breaker.

**4** Selectivity limit = 4 kA.

No selectivity.

**Note:** respect the basic rules of selectivity, in terms of overload, short-circuit, ground fault and earth leakage when applicable see page A-2, or check curves with Schneider Electric online "Electrical calculation tools".

# Selectivity table

Upstream: Masterpact MTZ2 08-20 L1 Micrologic X

Downstream: Compact NS630b-1600 Micrologic A/E/P

Ue ≤ 440 V AC



Upstream		Masterpact MTZ2 08/10/12/16/20 L1																			
Trip unit		Micrologic 2.0X Isd = 10Ir						Micrologic 5.0X - 6.0X - 7.0X Inst : 15 In Standard						Micrologic 5.0X - 6.0X - 7.0X Inst : OFF							
Downstream Rating (A)	Setting Ir	800		1000		1250		1600		2000		800		1000		1250		1600		2000	
		630	800	1000	1250	1600	2000	630	800	1000	1250	1600	2000	630	800	1000	1250	1600	2000		
<b>Selectivity limit (kA)</b>																					
<b>Compact NS630bN/H</b>	<b>250</b>	6.3	8	10	12.5	16	20	12	12	15	18.75	24	30	37	37	37	37	37	37	37	37
	<b>320</b>	6.3	8	10	12.5	16	20	12	12	15	18.75	24	30	37	37	37	37	37	37	37	37
	<b>400</b>	6.3	8	10	12.5	16	20	12	12	15	18.75	24	30	37	37	37	37	37	37	37	37
	<b>500</b>		8	10	12.5	16	20		12	15	18.75	24	30		37	37	37	37	37	37	37
	<b>630</b>			10	12.5	16	20			15	18.75	24	30			37	37	37	37	37	37
<b>Compact NS800N/H</b>	<b>320</b>	6.3	8	10	12.5	16	20	12	12	15	18.75	24	30	37	37	37	37	37	37	37	37
	<b>400</b>	6.3	8	10	12.5	16	20	12	12	15	18.75	24	30	37	37	37	37	37	37	37	37
	<b>500</b>		8	10	12.5	16	20		12	15	18.75	24	30		37	37	37	37	37	37	37
	<b>630</b>			10	12.5	16	20			15	18.75	24	30			37	37	37	37	37	37
	<b>800</b>				12.5	16	20				18.75	24	30				37	37	37	37	37
<b>Compact NS1000N/H</b>	<b>400</b>	6.3	8	10	12.5	16	20	12	12	15	18.75	24	30	37	37	37	37	37	37	37	37
	<b>500</b>		8	10	12.5	16	20		12	15	18.75	24	30		37	37	37	37	37	37	37
	<b>630</b>			10	12.5	16	20			15	18.75	24	30			37	37	37	37	37	37
	<b>800</b>				12.5	16	20				18.75	24	30				37	37	37	37	37
	<b>1000</b>					16	20					24	30					37	37	37	37
<b>Compact NS1250N/H</b>	<b>500</b>		8	10	12.5	16	20		12	15	18.75	24	30		37	37	37	37	37	37	37
	<b>630</b>			10	12.5	16	20			15	18.75	24	30			37	37	37	37	37	37
	<b>800</b>				12.5	16	20				18.75	24	30				37	37	37	37	37
	<b>1000</b>					16	20					24	30					37	37	37	37
	<b>1250</b>						20						30						37	37	37
<b>Compact NS1600N/H</b>	<b>630</b>			10	12.5	16	20			15	18.75	24	30			37	37	37	37	37	37
	<b>800</b>				12.5	16	20				18.75	24	30				37	37	37	37	37
	<b>960</b>					16	20					24	30					37	37	37	37
	<b>1250</b>						20						30						37	37	37
	<b>1600</b>																			37	37
<b>Compact NS630bL/LB</b>	<b>250</b>	6.3	8	10	T	T	T	T	T	T	T	T	T	T	T	T	T	T	T	T	T
	<b>320</b>	6.3	8	10	T	T	T	T	T	T	T	T	T	T	T	T	T	T	T	T	T
	<b>400</b>	6.3	8	10	T	T	T	T	T	T	T	T	T	T	T	T	T	T	T	T	T
	<b>500</b>		8	10	T	T	T		T	T	T	T	T		T	T	T	T	T	T	T
	<b>630</b>			10	T	T	T			T	T	T	T			T	T	T	T	T	T
<b>Compact NS800L/LB</b>	<b>320</b>	6.3	8	10	12.5	T	T	12	12	T	T	T	T	T	T	T	T	T	T	T	T
	<b>400</b>	6.3	8	10	12.5	T	T	12	12	T	T	T	T	T	T	T	T	T	T	T	T
	<b>500</b>		8	10	12.5	T	T		12	T	T	T	T		T	T	T	T	T	T	T
	<b>630</b>			10	12.5	T	T			T	T	T	T			T	T	T	T	T	T
	<b>800</b>				12.5	T	T				T	T	T				T	T	T	T	T
<b>Compact NS1000L</b>	<b>400</b>	6.3	8	10	12.5	T	T	12	12	T	T	T	T	T	T	T	T	T	T	T	T
	<b>500</b>		8	10	12.5	T	T		12	T	T	T	T		T	T	T	T	T	T	T
	<b>630</b>			10	12.5	T	T			T	T	T	T			T	T	T	T	T	T
	<b>800</b>				12.5	T	T				T	T	T				T	T	T	T	T
	<b>1000</b>					T	T					T	T					T	T	T	T

- T Total selectivity, up to the breaking capacity of the downstream circuit breaker.
- 4 Selectivity limit = 4 kA.
- No selectivity.

**Note:** respect the basic rules of selectivity, in terms of overload, short-circuit, ground fault and earth leakage when applicable see page A-2, or check curves with Schneider Electric online "Electrical calculation tools".

# Selectivity table

Upstream: Masterpact MTZ2 25-40 H1/H2, MTZ3 40-63 H1 Micrologic X  
 Downstream: iDPN, iC40, iC60, C120, NG125, Compact NSXm, NSX100-630, NS630b-3200

Ue ≤ 440 V AC

A

Upstream	Masterpact MTZ2 25/32/40 H1/H2	Masterpact MTZ3 40/50/63 H1	Masterpact MTZ2 25/32/40 H1/H2	Masterpact MTZ3 40/50/63 H1	Masterpact MTZ2 25/32/40 H1/H2	Masterpact MTZ3 40/50/63 H1
Trip unit	Micrologic 2.0X I <sub>sd</sub> = 10I <sub>r</sub>		Micrologic 5.0X - 6.0X - 7.0X Inst : 15 in Standard		Micrologic 5.0X - 6.0X - 7.0X Inst : OFF	

Downstream	Rating (A)	2500	3200	4000	4000	5000	6300	2500	3200	4000	4000	5000	6300	2500	3200	4000	4000	5000	6300
<b>Selectivity limit (kA)</b>																			
iDPN, iDPNN		T	T	T	T	T	T	T	T	T	T	T	T	T	T	T	T	T	T
iC40, iC40N		T	T	T	T	T	T	T	T	T	T	T	T	T	T	T	T	T	T
iC60		T	T	T	T	T	T	T	T	T	T	T	T	T	T	T	T	T	T
C120N/H		T	T	T	T	T	T	T	T	T	T	T	T	T	T	T	T	T	T
NG125N/H/L		T	T	T	T	T	T	T	T	T	T	T	T	T	T	T	T	T	T
Compact NSXm E/B/F/N/H		T	T	T	T	T	T	T	T	T	T	T	T	T	T	T	T	T	T
Compact NSX B/F/H/N/S/L/R TM-D	NSX100	T	T	T	T	T	T	T	T	T	T	T	T	T	T	T	T	T	T
	NSX250	T	T	T	T	T	T	T	T	T	T	T	T	T	T	T	T	T	T
Compact NSX160 B/F/H/N/S/L TM-D		T	T	T	T	T	T	T	T	T	T	T	T	T	T	T	T	T	T
Compact NSX B/F/H/N/S/L/R Micrologic	NSX100	T	T	T	T	T	T	T	T	T	T	T	T	T	T	T	T	T	T
	NSX250	T	T	T	T	T	T	T	T	T	T	T	T	T	T	T	T	T	T
F/H/N/S/L/R Micrologic		NSX400	T	T	T	T	T	T	T	T	T	T	T	T	T	T	T	T	T
NSX630		T	T	T	T	T	T	T	T	T	T	T	T	T	T	T	T	T	T
Compact NSX160 B/F/H/N/S/L Micrologic		T	T	T	T	T	T	T	T	T	T	T	T	T	T	T	T	T	T
Compact NS N Micrologic	NS630b	25	32	40	40	T	T	37.5	48	T	T	T	T	T	T	T	T	T	T
	NS800	25	32	40	40	T	T	37.5	48	T	T	T	T	T	T	T	T	T	T
	NS1000	25	32	40	40	T	T	37.5	48	T	T	T	T	T	T	T	T	T	T
	NS1250	25	32	40	40	T	T	37.5	48	T	T	T	T	T	T	T	T	T	T
	NS1600	25	32	40	40	T	T	37.5	48	T	T	T	T	T	T	T	T	T	T
Compact NS H Micrologic	NS630b	25	32	40	40	50	63	37.5	48	60	60	T	T	T	T	T	T	T	T
	NS800	25	32	40	40	50	63	37.5	48	60	60	T	T	T	T	T	T	T	T
	NS1000	25	32	40	40	50	63	37.5	48	60	60	T	T	T	T	T	T	T	T
	NS1250	25	32	40	40	50	63	37.5	48	60	60	T	T	T	T	T	T	T	T
	NS1600	25	32	40	40	50	63	37.5	48	60	60	T	T	T	T	T	T	T	T
Compact NS N Micrologic	NS1600b	25	32	40	40	50	63	37.5	48	60	60	T	T	T	T	T	T	T	T
	NS2000	25	32	40	40	50	63	37.5	48	60	60	T	T	T	T	T	T	T	T
	NS2500	25 <sup>[1]</sup>	32	40	40	50	63	37.5 <sup>[1]</sup>	48	60	60	T	T	T <sup>[1]</sup>	T	T	T	T	T
	NS3200		32 <sup>[1]</sup>	40	40	50	63		48 <sup>[1]</sup>	60	60	T	T	T <sup>[1]</sup>	T <sup>[1]</sup>	T	T	T	T
Compact NS H Micrologic	NS1600b	25	32	40	40	50	63	37.5	48	60	60	75	T	T	T	T	T	T	T
	NS2000	25	32	40	40	50	63	37.5	48	60	60	75	T	T	T	T	T	T	T
	NS2500	25 <sup>[1]</sup>	32	40	40	50	63	37.5 <sup>[1]</sup>	48	60	60	75	T	T <sup>[1]</sup>	T	T	T	T	T
	NS3200		32 <sup>[1]</sup>	40	40	50	63		48 <sup>[1]</sup>	60	60	75	T		T <sup>[1]</sup>	T	T	T	T
Compact NS L Micrologic	NS630b	T	T	T	T	T	T	T	T	T	T	T	T	T	T	T	T	T	T
	NS800	T	T	T	T	T	T	T	T	T	T	T	T	T	T	T	T	T	T
	NS1000	T	T	T	T	T	T	T	T	T	T	T	T	T	T	T	T	T	T
Compact NS LB Micrologic	NS630b	T	T	T	T	T	T	T	T	T	T	T	T	T	T	T	T	T	T
	NS800	T	T	T	T	T	T	T	T	T	T	T	T	T	T	T	T	T	T

- T** Total selectivity, up to the breaking capacity of the downstream circuit breaker.
- 4** Selectivity limit = 4 kA.
- No selectivity.

[1] With I<sub>r</sub> upstream > 1.3 I<sub>r</sub> downstream.

Note: respect the basic rules of selectivity, in terms of overload, short-circuit, ground fault and earth leakage when applicable see page A-2, or check curves with Schneider Electric online "Electrical calculation tools".



# Selectivity table

Upstream: Masterpact MTZ2 25-40 H1 Micrologic X

Downstream: Masterpact MTZ1 06-16, Masterpact MTZ2 08-20

Ue ≤ 440 V AC



Upstream	Masterpact MTZ2 25/32/40 H1								
Trip unit	Micrologic 2.0X Isd = 10Ir			Micrologic 5.0X - 6.0X - 7.0X Inst : 15 In Standard			Micrologic 5.0X - 6.0X - 7.0X Inst : OFF		

Downstream	Rating (kA)	2500	3200	4000	2500	3200	4000	2500	3200	4000
<b>Selectivity limit (A)</b>										
<b>Masterpact MTZ1 H1</b> Micrologic 2.0 - 5.0 - 6.0 - 7.0 X	MTZ1 06	25	32	40	37.5	T	T	T	T	T
	MTZ1 08	25	32	40	37.5	T	T	T	T	T
	MTZ1 10	25	32	40	37.5	T	T	T	T	T
	MTZ1 12	25	32	40	37.5	T	T	T	T	T
<b>Masterpact MTZ1 H2</b> Micrologic 2.0 - 5.0 - 6.0 - 7.0 X	MTZ1 06	25	32	40	37.5	48	T	T	T	T
	MTZ1 08	25	32	40	37.5	48	T	T	T	T
	MTZ1 10	25	32	40	37.5	48	T	T	T	T
	MTZ1 12	25	32	40	37.5	48	T	T	T	T
<b>Masterpact MTZ1 H3</b> Micrologic 2.0 - 5.0 - 6.0 - 7.0 X	MTZ1 06	25	32	40	37.5	48	60	T	T	T
	MTZ1 08	25	32	40	37.5	48	60	T	T	T
	MTZ1 10	25	32	40	37.5	48	60	T	T	T
	MTZ1 12	25	32	40	37.5	48	60	T	T	T
<b>Masterpact MTZ2 N1</b> Micrologic 2.0 - 5.0 - 6.0 - 7.0 X	MTZ2 08	25	32	40	37.5	T	T	T	T	T
	MTZ2 10	25	32	40	37.5	T	T	T	T	T
	MTZ2 12	25	32	40	37.5	T	T	T	T	T
	MTZ2 16	25	32	40	37.5	T	T	T	T	T
<b>Masterpact MTZ2 H1</b> Micrologic 2.0 - 5.0 - 6.0 - 7.0 X	MTZ2 08	25	32	40	37.5	48	60	T	T	T
	MTZ2 10	25	32	40	37.5	48	60	T	T	T
	MTZ2 12	25	32	40	37.5	48	60	T	T	T
	MTZ2 16	25	32	40	37.5	48	60	T	T	T
	MTZ2 20	25	32	40	37.5	48	60	T	T	T
	MTZ2 25	25 <sup>[1]</sup>	32	40	37.5 <sup>[1]</sup>	48	60	T <sup>[1]</sup>	T	T
<b>Masterpact MTZ2 H2</b> Micrologic 2.0 - 5.0 - 6.0 - 7.0 X	MTZ2 08	25	32	40	37.5	48	60	T	T	T
	MTZ2 10	25	32	40	37.5	48	60	T	T	T
	MTZ2 12	25	32	40	37.5	48	60	T	T	T
	MTZ2 16	25	32	40	37.5	48	60	T	T	T
	MTZ2 20	25	32	40	37.5	48	60	T	T	T
	MTZ2 25	25 <sup>[1]</sup>	32	40	37.5 <sup>[1]</sup>	48	60	T <sup>[1]</sup>	T	T
<b>Masterpact MTZ2 H3</b> Micrologic 2.0 - 5.0 - 6.0 - 7.0 X	MTZ2 20	25	32	40	37.5	48	60	T	T	T
	MTZ2 25	25 <sup>[1]</sup>	32	40	37.5 <sup>[1]</sup>	48	60	T <sup>[1]</sup>	T	T
	MTZ2 32		32 <sup>[1]</sup>	40		48 <sup>[1]</sup>	60		T <sup>[1]</sup>	T
<b>Masterpact MTZ1 L1</b> Micrologic 2.0 - 5.0 - 6.0 - 7.0 X	MTZ1 06	T	T	T	T	T	T	T	T	T
	MTZ1 08	T	T	T	T	T	T	T	T	T
	MTZ1 10	T	T	T	T	T	T	T	T	T
<b>Masterpact MTZ2 L1</b> Micrologic 2.0 - 5.0 - 6.0 - 7.0 X	MTZ2 08	25	32	40	37.5	48	60	T	T	T
	MTZ2 10	25	32	40	37.5	48	60	T	T	T
	MTZ2 12	25	32	40	37.5	48	60	T	T	T
	MTZ2 16	25	32	40	37.5	48	60	T	T	T

**T** Total selectivity, up to the breaking capacity of the downstream circuit breaker.

**4** Selectivity limit = 4 kA.

No selectivity.

[1] With Ir upstream > 1.3 Ir downstream.

**Note:** respect the basic rules of selectivity, in terms of overload, short-circuit, ground fault and earth leakage when applicable see page A-2, or check curves with Schneider Electric online "Electrical calculation tools".

# Selectivity table

Upstream: Masterpact MTZ2 20/25/32/40 H2, MTZ3 40/50/63 H1 Micrologic X

Downstream: Masterpact MTZ1 06-16, MTZ2 08-40, MTZ3 40/50

Ue ≤ 440 V AC

A

Upstream	Masterpact MTZ2 20/25/32/40 H2	Masterpact MTZ3 40/50/63 H1	Masterpact MTZ2 20/25/32/40 H2	Masterpact MTZ3 40/50/63 H1	Masterpact MTZ2 20/25/32/40 H2	Masterpact MTZ3 40/50/63 H1
Trip unit	Micrologic 2.0X Isd = 10Ir		Micrologic 5.0X - 6.0X - 7.0X Inst : 15 In Standard		Micrologic 5.0X - 6.0X - 7.0X Inst : OFF	

Downstream	Rating (A)	2500	3200	4000	4000	5000	6300	2500	3200	4000	4000	5000	6300	2500	3200	4000	4000	5000	6300
<b>Selectivity limit (kA)</b>																			
Masterpact MTZ1 H1 Micrologic 2.0 - 5.0 - 6.0 - 7.0 X	MTZ1 06	25	32	40	40	T	T	37.5	T	T	T	T	T	T	T	T	T	T	T
	MTZ1 08	25	32	40	40	T	T	37.5	T	T	T	T	T	T	T	T	T	T	T
	MTZ1 10	25	32	40	40	T	T	37.5	T	T	T	T	T	T	T	T	T	T	T
	MTZ1 12	25	32	40	40	T	T	37.5	T	T	T	T	T	T	T	T	T	T	T
Masterpact MTZ1 H2 Micrologic 2.0 - 5.0 - 6.0 - 7.0 X	MTZ1 06	25	32	40	40	T	T	37.5	48	T	T	T	T	T	T	T	T	T	T
	MTZ1 08	25	32	40	40	T	T	37.5	48	T	T	T	T	T	T	T	T	T	T
	MTZ1 10	25	32	40	40	T	T	37.5	48	T	T	T	T	T	T	T	T	T	T
	MTZ1 12	25	32	40	40	T	T	37.5	48	T	T	T	T	T	T	T	T	T	T
Masterpact MTZ1 H3 Micrologic 2.0 - 5.0 - 6.0 - 7.0 X	MTZ1 06	25	32	40	40	50	63	37.5	48	60	60	T	T	T	T	T	T	T	T
	MTZ1 08	25	32	40	40	50	63	37.5	48	60	60	T	T	T	T	T	T	T	T
	MTZ1 10	25	32	40	40	50	63	37.5	48	60	60	T	T	T	T	T	T	T	T
	MTZ1 12	25	32	40	40	50	63	37.5	48	60	60	T	T	T	T	T	T	T	T
Masterpact MTZ2 N1 Micrologic 2.0 - 5.0 - 6.0 - 7.0 X	MTZ2 08	25	32	40	40	T	T	37.5	T	T	T	T	T	T	T	T	T	T	T
	MTZ2 10	25	32	40	40	T	T	37.5	T	T	T	T	T	T	T	T	T	T	T
	MTZ2 12	25	32	40	40	T	T	37.5	T	T	T	T	T	T	T	T	T	T	T
	MTZ2 16	25	32	40	40	T	T	37.5	T	T	T	T	T	T	T	T	T	T	T
Masterpact MTZ2 H1 Micrologic 2.0 - 5.0 - 6.0 - 7.0 X	MTZ2 08	25	32	40	40	50	63	37.5	48	60	60	T	T	T	T	T	T	T	T
	MTZ2 10	25	32	40	40	50	63	37.5	48	60	60	T	T	T	T	T	T	T	T
	MTZ2 12	25	32	40	40	50	63	37.5	48	60	60	T	T	T	T	T	T	T	T
	MTZ2 16	25	32	40	40	50	63	37.5	48	60	60	T	T	T	T	T	T	T	T
	MTZ2 20	25	32	40	40	50	63	37.5	48	60	60	T	T	T	T	T	T	T	T
	MTZ2 25	25 <sup>[1]</sup>	32	40	40	50	63	37.5 <sup>[1]</sup>	48	60	60	T	T	T <sup>[1]</sup>	T	T	T	T	T
Masterpact MTZ2 H2 Micrologic 2.0 - 5.0 - 6.0 - 7.0 X	MTZ2 30		32 <sup>[1]</sup>	40	40	50	63		48 <sup>[1]</sup>	60	60	T	T		T <sup>[1]</sup>	T	T	T	T
	MTZ2 40			40 <sup>[1]</sup>	40 <sup>[1]</sup>	50	63			60 <sup>[1]</sup>	60	T	T			T <sup>[1]</sup>	T <sup>[1]</sup>	T <sup>[1]</sup>	T
	MTZ2 08	25	32	40	40	50	63	37.5	48	60	60	75	94	82	82	82	82	T	T
	MTZ2 10	25	32	40	40	50	63	37.5	48	60	60	75	94	82	82	82	82	T	T
Masterpact MTZ3 H1	MTZ3 40			40 <sup>[1]</sup>	40 <sup>[1]</sup>	50	63			60 <sup>[1]</sup>	60 <sup>[1]</sup>	75	94			T <sup>[1]</sup>	T <sup>[1]</sup>	T	T
	MTZ3 50					50 <sup>[1]</sup>	63					75 <sup>[1]</sup>	94					T <sup>[1]</sup>	T
	MTZ2 20	25	32	40	40	50	63	37.5	48	60	60	75	94	82	82	82	82	T	T
	MTZ2 25	25 <sup>[1]</sup>	32	40	40	50	63	37.5 <sup>[1]</sup>	48	60	60	75	94	82 <sup>[1]</sup>	82	82	82	T	T
Masterpact MTZ2 L1 Micrologic 2.0 - 5.0 - 6.0 - 7.0 X	MTZ2 32		32 <sup>[1]</sup>	40	40	50	63		48 <sup>[1]</sup>	60	60	75	94			82 <sup>[1]</sup>	82	T	T
	MTZ2 40			40 <sup>[1]</sup>	40 <sup>[1]</sup>	50	63			60 <sup>[1]</sup>		75	94				82 <sup>[1]</sup>	T <sup>[1]</sup>	T
	MTZ3 40					40 <sup>[1]</sup>	50			60 <sup>[1]</sup>	60 <sup>[1]</sup>	75	94			T <sup>[1]</sup>	T <sup>[1]</sup>	T	T
	MTZ3 50					50 <sup>[1]</sup>	63					75 <sup>[1]</sup>	94					T <sup>[1]</sup>	T
Masterpact MTZ2 L1 Micrologic 2.0 - 5.0 - 6.0 - 7.0 X	MTZ2 08	25	32	40	40	50	63	37.5	48	60	60	75	94	T	T	T	T	T	T
	MTZ2 10	25	32	40	40	50	63	37.5	48	60	60	75	94	T	T	T	T	T	T
	MTZ2 12	25	32	40	40	50	63	37.5	48	60	60	75	94	T	T	T	T	T	T
	MTZ2 16	25	32	40	40	50	63	37.5	48	60	60	75	94	T	T	T	T	T	T
Masterpact MTZ2 L1 Micrologic 2.0 - 5.0 - 6.0 - 7.0 X	MTZ2 20	25	32	40	40	50	63	37.5	48	60	60	75	94	T	T	T	T	T	T
	MTZ2 25	25	32	40	40	50	63	37.5	48	60	60	75	94	T	T	T	T	T	T

**T** Total selectivity, up to the breaking capacity of the downstream circuit breaker.

**4** Selectivity limit = 4 kA.

No selectivity.

[1] With Ir upstream > 1.3 Ir downstream.

Note: respect the basic rules of selectivity, in terms of overload, short-circuit, ground fault and earth leakage when applicable see page A-2, or check curves with Schneider Electric online "Electrical calculation tools".

# Selectivity table

Upstream: Masterpact MTZ2 20/25/32/40 H3, MTZ3 40/50/63 H2 Micrologic X  
 Downstream: iDPN, iC60, iC40, C120, NG125, Compact NSXm, NSX100-630, NS630b-3200

Ue ≤ 440 V AC



Upstream	Masterpact MTZ2 20/25/32/40 H3	Masterpact MTZ3 40/50/63 H2	Masterpact MTZ2 20/25/32/40 H3	Masterpact MTZ3 40/50/63 H2	Masterpact MTZ2 20/25/32/40 H3	Masterpact MTZ3 40/50/63 H2
Trip unit	Micrologic 2.0X I <sub>sd</sub> = 10I <sub>r</sub>		Micrologic 5.0X - 6.0X - 7.0X Inst : 15 In Standard		Micrologic 5.0X - 6.0X - 7.0X Inst : OFF	

Downstream Rating (A)	2000	2500	3200	4000	4000	5000	6300	2000	2500	3200	4000	4000	5000	6300	2000	2500	3200	4000	4000	5000	6300	
<b>Selectivity limit (kA)</b>																						
iDPN, iDPNN	T	T	T	T	T	T	T	T	T	T	T	T	T	T	T	T	T	T	T	T	T	
iC40, iC40N	T	T	T	T	T	T	T	T	T	T	T	T	T	T	T	T	T	T	T	T	T	
iC60	T	T	T	T	T	T	T	T	T	T	T	T	T	T	T	T	T	T	T	T	T	
C120N/H	T	T	T	T	T	T	T	T	T	T	T	T	T	T	T	T	T	T	T	T	T	
NG125N/H/L	T	T	T	T	T	T	T	T	T	T	T	T	T	T	T	T	T	T	T	T	T	
Compact NSXm E/B/F/N/H	T	T	T	T	T	T	T	T	T	T	T	T	T	T	T	T	T	T	T	T	T	
Compact B/F/H/N/S/L/R TM-D	NSX100	T	T	T	T	T	T	T	T	T	T	T	T	T	T	T	T	T	T	T	T	
	NSX250	T	T	T	T	T	T	T	T	T	T	T	T	T	T	T	T	T	T	T	T	
Compact NSX160 B/F/H/N/S/L TM-D	T	T	T	T	T	T	T	T	T	T	T	T	T	T	T	T	T	T	T	T	T	
Compact B/F/H/N/S/L/R Micrologic	NSX100	T	T	T	T	T	T	T	T	T	T	T	T	T	T	T	T	T	T	T	T	
	NSX250	T	T	T	T	T	T	T	T	T	T	T	T	T	T	T	T	T	T	T	T	
Compact NSX160 B/F/H/N/S/L Micrologic	T	T	T	T	T	T	T	T	T	T	T	T	T	T	T	T	T	T	T	T	T	
Compact F/H/N/S/L/R	NSX400	T	T	T	T	T	T	T	T	T	T	T	T	T	T	T	T	T	T	T	T	
	NSX630	T	T	T	T	T	T	T	T	T	T	T	T	T	T	T	T	T	T	T	T	
Compact N Micrologic	NS630b	20	25	32	40	40	T	T	30	37.5	48	T	T	T	T	T	T	T	T	T	T	
	NS800	20	25	32	40	40	T	T	30	37.5	48	T	T	T	T	T	T	T	T	T	T	
	NS1000	20	25	32	40	40	T	T	30	37.5	48	T	T	T	T	T	T	T	T	T	T	
	NS1250	20	25	32	40	40	T	T	30	37.5	48	T	T	T	T	T	T	T	T	T	T	
	NS1600	20	25	32	40	40	T	T	30	37.5	48	T	T	T	T	T	T	T	T	T	T	
Compact H Micrologic	NS630b	20	25	32	40	40	50	63	30	37.5	48	60	60	T	T	65	65	65	65	T	T	T
	NS800	20	25	32	40	40	50	63	30	37.5	48	60	60	T	T	65	65	65	65	T	T	T
	NS1000	20	25	32	40	40	50	63	30	37.5	48	60	60	T	T	65	65	65	65	T	T	T
	NS1250	20	25	32	40	40	50	63	30	37.5	48	60	60	T	T	65	65	65	65	T	T	T
	NS1600	20	25	32	40	40	50	63	30	37.5	48	60	60	T	T	65	65	65	65	T	T	T
Compact N Micrologic	NS1600b	20	25	32	40	40	50	63	30	37.5	48	60	60	T	T	65	65	65	65	T	T	T
	NS2000	20 <sup>[1]</sup>	25	32	40	40	50	63	30 <sup>[1]</sup>	37.5	48	60	60	T	T	65 <sup>[1]</sup>	65	65	65	T	T	T
	NS2500		25 <sup>[1]</sup>	32	40	40	50	63		37.5 <sup>[1]</sup>	48	60	60	T	T		65 <sup>[1]</sup>	65	65	T	T	T
	NS3200			32 <sup>[1]</sup>	40	40	50	63			48 <sup>[1]</sup>	60	60	T	T		65 <sup>[1]</sup>	65 <sup>[1]</sup>	65	T	T	T
Compact H Micrologic	NS1600b	20	25	32	40	40	50	63	30	37.5	48	60	60	75	T	65	65	65	65	T	T	T
	NS2000	20 <sup>[1]</sup>	25	32	40	40	50	63	30 <sup>[1]</sup>	37.5	48	60	60	75	T	65 <sup>[1]</sup>	65	65	65	T	T	T
	NS2500		25 <sup>[1]</sup>	32	40	40	50	63		37.5 <sup>[1]</sup>	48	60	60	75	T		65 <sup>[1]</sup>	65	65	T	T	T
	NS3200			32 <sup>[1]</sup>	40	40	50	63			48 <sup>[1]</sup>	60	60	75	T		65 <sup>[1]</sup>	65 <sup>[1]</sup>	65	T	T	T
Compact L Micrologic	NS630b	T	T	T	T	T	T	T	T	T	T	T	T	T	T	T	T	T	T	T	T	
	NS800	T	T	T	T	T	T	T	T	T	T	T	T	T	T	T	T	T	T	T	T	
	NS1000	T	T	T	T	T	T	T	T	T	T	T	T	T	T	T	T	T	T	T	T	
Compact LB Micrologic	NS630b	T	T	T	T	T	T	T	T	T	T	T	T	T	T	T	T	T	T	T	T	
	NS800	T	T	T	T	T	T	T	T	T	T	T	T	T	T	T	T	T	T	T	T	

- T Total selectivity, up to the breaking capacity of the downstream circuit breaker.
- 4 Selectivity limit = 4 kA.
- No selectivity.

[1] With I<sub>r</sub> upstream > 1.3 I<sub>r</sub> downstream.

Note: respect the basic rules of selectivity, in terms of overload, short-circuit, ground fault and earth leakage when applicable see page A-2, or check curves with Schneider Electric online "Electrical calculation tools".

# Selectivity table

Upstream: Masterpact MTZ2 20/25/32/40 H3, MTZ3 40/50/63 H2 Micrologic X

Downstream: Masterpact MTZ1 06-16, MTZ2 08-40 and MTZ3 40/50

$U_e \leq 440 \text{ V AC}$

A

Upstream	Masterpact MTZ2 20/25/32/40 H3	Masterpact MTZ3 40/50/63 H2	Masterpact MTZ2 20/25/32/40 H3	Masterpact MTZ3 40/50/63 H2	Masterpact MTZ2 20/25/32/40 H3	Masterpact MTZ3 40/50/63 H2
Trip unit	Micrologic 2.0X I <sub>sd</sub> = 10Ir		Micrologic 5.0X - 6.0X - 7.0X Inst : 15 In Standard		Micrologic 5.0X - 6.0X - 7.0X Inst : OFF	

Downstream	Rating (A)	2000	2500	3200	4000	4000	5000	6300	2000	2500	3200	4000	4000	5000	6300	2000	2500	3200	4000	4000	5000	6300
<b>Selectivity limit (kA)</b>																						
<b>Masterpact MTZ1 H1</b>	<b>MTZ1 06</b>	20	25	32	40	40	T	T	30	37.5	T	T	T	T	T	T	T	T	T	T	T	T
<b>Micrologic 2.0 - 5.0 - 6.0 - 7.0 X</b>	<b>MTZ1 10</b>	20	25	32	40	40	T	T	30	37.5	T	T	T	T	T	T	T	T	T	T	T	T
	<b>MTZ1 12</b>	20	25	32	40	40	T	T	30	37.5	T	T	T	T	T	T	T	T	T	T	T	T
	<b>MTZ1 16</b>	20	25	32	40	40	T	T	30	37.5	T	T	T	T	T	T	T	T	T	T	T	T
<b>Masterpact MTZ1 H2</b>	<b>MTZ1 06</b>	20	25	32	40	40	T	T	30	37.5	48	T	T	T	T	T	T	T	T	T	T	T
<b>Micrologic 2.0 - 5.0 - 6.0 - 7.0 X</b>	<b>MTZ1 08</b>	20	25	32	40	40	T	T	30	37.5	48	T	T	T	T	T	T	T	T	T	T	T
	<b>MTZ1 10</b>	20	25	32	40	40	T	T	30	37.5	48	T	T	T	T	T	T	T	T	T	T	T
	<b>MTZ1 12</b>	20	25	32	40	40	T	T	30	37.5	48	T	T	T	T	T	T	T	T	T	T	T
	<b>MTZ1 16</b>	20	25	32	40	40	T	T	30	37.5	48	T	T	T	T	T	T	T	T	T	T	T
<b>Masterpact MTZ1 H3</b>	<b>MTZ1 06</b>	20	25	32	40	40	50	63	30	37.5	48	60	60	T	T	T	T	T	T	T	T	T
<b>Micrologic 2.0 - 5.0 - 6.0 - 7.0 X</b>	<b>MTZ1 08</b>	20	25	32	40	40	50	63	30	37.5	48	60	60	T	T	T	T	T	T	T	T	T
	<b>MTZ1 10</b>	20	25	32	40	40	50	63	30	37.5	48	60	60	T	T	T	T	T	T	T	T	T
	<b>MTZ1 12</b>	20	25	32	40	40	50	63	30	37.5	48	60	60	T	T	T	T	T	T	T	T	T
	<b>MTZ1 16</b>	20	25	32	40	40	50	63	30	37.5	48	60	60	T	T	T	T	T	T	T	T	T
<b>Masterpact MTZ2 N1</b>	<b>MTZ2 08</b>	20	25	32	40	40	T	T	30	37.5	T	T	T	T	T	T	T	T	T	T	T	T
<b>Micrologic 2.0 - 5.0 - 6.0 - 7.0 X</b>	<b>MTZ2 10</b>	20	25	32	40	40	T	T	30	37.5	T	T	T	T	T	T	T	T	T	T	T	T
	<b>MTZ2 12</b>	20	25	32	40	40	T	T	30	37.5	T	T	T	T	T	T	T	T	T	T	T	T
	<b>MTZ2 16</b>	20	25	32	40	40	T	T	30	37.5	T	T	T	T	T	T	T	T	T	T	T	T
<b>Masterpact MTZ2 H1</b>	<b>MTZ2 08</b>	20	25	32	40	40	50	63	30	37.5	48	60	60	T	T	T	T	T	T	T	T	T
<b>Micrologic 2.0 - 5.0 - 6.0 - 7.0 X</b>	<b>MTZ2 10</b>	20	25	32	40	40	50	63	30	37.5	48	60	60	T	T	T	T	T	T	T	T	T
	<b>MTZ2 12</b>	20	25	32	40	40	50	63	30	37.5	48	60	60	T	T	T	T	T	T	T	T	T
	<b>MTZ2 16</b>	20	25	32	40	40	50	63	30	37.5	48	60	60	T	T	T	T	T	T	T	T	T
	<b>MTZ2 20</b>	20 <sup>[1]</sup>	25	32	40	40	50	63	30 <sup>[1]</sup>	37.5	48	60	60	T	T	T	T	T	T	T	T	T
	<b>MTZ2 25</b>		25 <sup>[1]</sup>	32	40	40	50	63		37.5 <sup>[1]</sup>	48	60	60	T	T		T <sup>[1]</sup>	T	T	T	T	T
	<b>MTZ2 32</b>			32 <sup>[1]</sup>	40	40	50	63			48 <sup>[1]</sup>	60	60	T	T			T <sup>[1]</sup>	T	T	T	T
	<b>MTZ2 40</b>				40 <sup>[1]</sup>	40 <sup>[1]</sup>	50	63				60 <sup>[1]</sup>	60	T	T				T <sup>[1]</sup>	T	T	T
<b>Masterpact MTZ2 H2</b>	<b>MTZ2 08</b>	20	25	32	40	40	50	63	30	37.5	48	60	60	75	94	65	65	65	65	T	T	T
<b>Micrologic 2.0 - 5.0 - 6.0 - 7.0 X</b>	<b>MTZ2 10</b>	20	25	32	40	40	50	63	30	37.5	48	60	60	75	94	65	65	65	65	T	T	T
	<b>MTZ2 12</b>	20	25	32	40	40	50	63	30	37.5	48	60	60	75	94	65	65	65	65	T	T	T
	<b>MTZ2 16</b>	20	25	32	40	40	50	63	30	37.5	48	60	60	75	94	65	65	65	65	T	T	T
	<b>MTZ2 20</b>	20 <sup>[1]</sup>	25	32	40	40	50	63	30 <sup>[1]</sup>	37.5	48	60	60	75	94	65 <sup>[1]</sup>	65	65	65	T	T	T
	<b>MTZ2 25</b>		25 <sup>[1]</sup>	32	40	40	50	63		37.5 <sup>[1]</sup>	48	60	60	75	94		65 <sup>[1]</sup>	65	65	T	T	T
	<b>MTZ2 32</b>			32 <sup>[1]</sup>	40	40	50	63			48 <sup>[1]</sup>	60	60	75	94			65 <sup>[1]</sup>	65	T	T	T
	<b>MTZ2 40</b>				40 <sup>[1]</sup>	40 <sup>[1]</sup>	50	63				60 <sup>[1]</sup>	60	75	94				65 <sup>[1]</sup>	T <sup>[1]</sup>	T	T
<b>Masterpact MTZ3 H1</b>	<b>MTZ3 40</b>				40 <sup>[1]</sup>	40 <sup>[1]</sup>	50	63				60 <sup>[1]</sup>	75	94	94					65 <sup>[1]</sup>	T <sup>[1]</sup>	T
	<b>MTZ3 50</b>					50 <sup>[1]</sup>	63						75 <sup>[1]</sup>	94	94						T <sup>[1]</sup>	T
<b>Masterpact MTZ2 H3</b>	<b>MTZ2 20</b>	20 <sup>[1]</sup>	25	32	40	40	50	63	30 <sup>[1]</sup>	37.5	48	60	60	75	94	65 <sup>[1]</sup>	65	65	65	120	120	120
<b>Micrologic 2.0 - 5.0 - 6.0 - 7.0 X</b>	<b>MTZ2 25</b>		25 <sup>[1]</sup>	32	40	40	50	63		37.5 <sup>[1]</sup>	48	60	60	75	94		65 <sup>[1]</sup>	65	65	120	120	120
	<b>MTZ2 32</b>			32 <sup>[1]</sup>	40	40	50	63			48 <sup>[1]</sup>	60	60	75	94			65 <sup>[1]</sup>	65	120	120	120
	<b>MTZ2 40</b>				40 <sup>[1]</sup>	40 <sup>[1]</sup>	50	63				60 <sup>[1]</sup>	60	75	94				65 <sup>[1]</sup>	120 <sup>[1]</sup>	120	120
<b>Masterpact MTZ3 H2</b>	<b>MTZ3 40</b>				40 <sup>[1]</sup>	40 <sup>[1]</sup>	50	63				60 <sup>[1]</sup>	75	75	94				65 <sup>[1]</sup>	120 <sup>[1]</sup>	120	120
	<b>MTZ3 50</b>					50 <sup>[1]</sup>	63						75 <sup>[1]</sup>	94	94					120 <sup>[1]</sup>	120	120
<b>Masterpact MTZ1 L1</b>	<b>MTZ1 06</b>	T	T	T	T	T	T	T	T	T	T	T	T	T	T	T	T	T	T	T	T	T
<b>Micrologic 2.0 - 5.0 - 6.0 - 7.0 X</b>	<b>MTZ1 08</b>	T	T	T	T	T	T	T	T	T	T	T	T	T	T	T	T	T	T	T	T	T
	<b>MTZ1 10</b>	T	T	T	T	T	T	T	T	T	T	T	T	T	T	T	T	T	T	T	T	T
<b>Masterpact MTZ2 L1</b>	<b>MTZ2 08</b>	20	25	32	40	40	50	63	30	37.5	48	60	60	75	94	100	100	100	100	T	T	T
<b>Micrologic 2.0 - 5.0 - 6.0 - 7.0 X</b>	<b>MTZ2 10</b>	20	25	32	40	40	50	63	30	37.5	48	60	60	75	94	100	100	100	100	T	T	T
	<b>MTZ2 12</b>	20	25	32	40	40	50	63	30	37.5	48	60	60	75	94	100	100	100	100	T	T	T
	<b>MTZ2 16</b>	20	25	32	40	40	50	63	30	37.5	48	60	60	75	94	100	100	100	100	T	T	T
	<b>MTZ2 20</b>	20	25	32	40	40	50	63		37.5	48	60	60	75	94		100	100	100	T	T	T

T Total selectivity, up to the breaking capacity of the downstream circuit breaker.

4 Selectivity limit = 4 kA.

No selectivity.

[1] With I<sub>r</sub> upstream > 1.3 I<sub>r</sub> downstream.

Note: respect the basic rules of selectivity, in terms of overload, short-circuit, ground fault and earth leakage when applicable see page A-2, or check curves with Schneider Electric online "Electrical calculation tools".

# Selectivity tables for direct current application

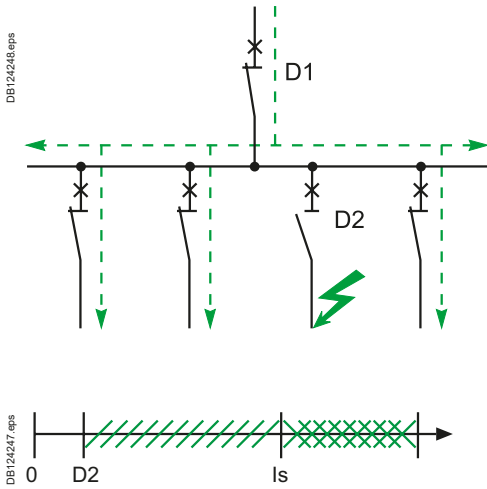

## Continuity of service

Selectivity is a key element that must be taken into account right from the design stage of a low-voltage installation to allow continuity of service of the electrical power.

Selectivity involves coordination between two circuit breakers connected in series, so that in the event of a fault, only the circuit breaker positioned immediately upstream of the fault trips. A selectivity current  $I_s$  is defined as:

- $I_{\text{fault}} < I_s$ : only D2 removes the fault, selectivity ensured,
- $I_{\text{fault}} > I_s$ : both circuit breakers may trip, selectivity not ensured.

Selectivity may be partial or total, up to the breaking capacity of the downstream circuit breaker.

- **Total**: up to the breaking capacity of the downstream device.
- **Partial**: indication of the selectivity limit current  $I_s$ . Selectivity is ensured below this value; above this value, the upstream device participates in the breaking process.
- **None**: no selectivity ensured, the upstream and downstream circuit breakers will trip.

## How to use the tables:

In the following pages are provided selectivity tables for the following system:

- 24-48 60 Vdc
- 110-125 Vdc
- 220-250 Vdc

With time constant from 1.5 to 25 ms

Suitability of circuit breakers according to voltage and earthing system shall be checked before using these tables. Selection of devices in DC can be challenging due to the diversity of voltage levels and earthing system. See product catalog or guides for DC application.

In this document we will consider the following cases:

IT	TN		
<p>Isolated from earth + and - conductors protected and disconnected</p> <p>DB425316 eps</p> <p>Case 1</p>	<p>- (or +) earthed '+ and - conductors protected and disconnected</p> <p>DB425317 eps</p> <p>Case 2</p>	<p>Midpoint earthed (not distributed) + and - conductors protected and disconnected</p> <p>DB425317 eps</p> <p>Case 3</p>	<p>- (or +) earthed '+ (or -) conductors protected and disconnected</p> <p>DB425318 eps</p> <p>Case 4</p>

For one given voltage the selectivity table is applicable for Case 1, Case 2, Case 3, Case 4 with this voltage between + and - for all types of fault. (In IT, Case 1, circuit breaker will not trip during first fault to earth)

For one given voltage selectivity limits in the table can also apply to system with higher voltage (up to 2 times) for all type of fault in Case 3 and for + to - fault only (Fault "B") in Case 1 if the same circuit breakers with same number of poles can be used at this higher voltage.

# Selectivity table

Upstream: iC60 curve B

Downstream: iC60 curves B, C, D, C60H-DC curve C



Ue: 24-48-60 V DC<sup>[3]</sup>

Time constant: 1.5 ms - 25 ms

Upstream	iC60N/H/L, 1P or 2P <sup>[1]</sup>										
	Curve B										
In (A)	3	4	6	10	16	20	25	32	40	50	63

Downstream													
Circuit breaker	Curve	Rating (A)	Selectivity limit (A) <sup>[2]</sup>										
iC60N/H/L 1P or 2P <sup>[1]</sup>	B	≤ 1		T	T	T	T	T	T	T	T	T	
		2				T	T	T	T	T	T	T	
		3				150	1200	T	T	T	T	T	
		4						500	900	T	T	T	
		6							300	700	1000	1800	4000
		10								400	500	800	1000
		≥ 16											
	C	≤ 1		T	T	T	T	T	T	T	T	T	
		2				T	T	T	T	T	T	T	
		3				150	1200	T	T	T	T	T	
		4						400	900	T	T	T	
		6							300	700	1000	1800	3000
		10								300	500	700	800
		≥ 16											
	D	≤ 1			T	T	T	T	T	T	T	T	
		2				1600	T	T	T	T	T	T	
		3					900	11000	T	T	T	T	
		4							700	T	T	T	
		6								500	800	1800	3000
		10									400	600	800
		≥ 16											
C60H-DC 1P or 2P <sup>[1]</sup>	C	≤ 1		T	T	T	T	T	T	T	T		
		2				T	T	T	T	T	T		
		3				150	1200	T	T	T	T		
		4						400	900	T	T		
		6							300	700	1000	1800	3000
		10								300	500	700	800
		≥ 16											

- T : Total selectivity.
- 700 : Selectivity limit = 700 A
- : No selectivity.

[1] Type of circuit breaker depend on earthing system and circuit breaker ranges (see Distribution guide direct current CA908061).

[2] According to the voltage and number of pole used, the breaking capacity can be changed. Selectivity limit is the minimum of the value indicated in the table and the breaking capacity of downstream circuit breaker.

[3] This table is applicable for Case 1, Case 2, Case 3, Case 4 defined in introduction with this voltage between + and - Selectivity limits in this table for Case 3 and Case 4 can also apply to system with higher voltage (up to 2 times) for the same circuit breaker (same number of poles used).

Compliance of circuit breakers according to voltage and earthing system shall be checked before using this table.

# Selectivity table

Upstream: iC60 curve C

Downstream: iC60 curves B, C, D, C60H-DC curve C

Ue: 24-48-60 V DC<sup>[3]</sup>

Time constant: 1.5 ms - 25 ms



Upstream	iC60N/H/L, 1P or 2P <sup>[1]</sup>											
	Curve C											
In (A)	3	4	6	10	16	20	25	32	40	50	63	

Downstream													
Circuit breaker	Curve	Rating (A)	Selectivity limit (A) <sup>[2]</sup>										
iC60N/H/L 1P or 2P <sup>[1]</sup>	B	≤ 1	T	T	T	T	T	T	T	T	T	T	T
		2			700	T	T	T	T	T	T	T	T
		3				900	T	T	T	T	T	T	T
		4					900	8000	T	T	T	T	T
		6						900	1800	3200	T	T	T
		10							700	800	1500	2000	
		16									1000	1200	
		≥ 20											
	C	≤ 1	T	T	T	T	T	T	T	T	T	T	T
		2			500	T	T	T	T	T	T	T	T
		3				900	T	T	T	T	T	T	T
		4					900	6700	T	T	T	T	T
		6						700	1400	3200	T	T	T
		10							700	800	1500	2000	
		16									1000	1200	
		≥ 20											
	D	≤ 1	T	T	T	T	T	T	T	T	T	T	T
		2			350	T	T	T	T	T	T	T	T
		3				700	T	T	T	T	T	T	T
		4					700	4000	T	T	T	T	T
		6						700	1400	3200	T	T	T
10								500	800	1500	1800		
16										1000	1200		
≥ 20													
C60H-DC 1P or 2P <sup>[1]</sup>	C	≤ 1	T	T	T	T	T	T	T	T	T	T	T
		2			500	T	T	T	T	T	T	T	T
		3				900	T	T	T	T	T	T	T
		4					900	6700	T	T	T	T	T
		6						700	1400	3200	T	T	T
		10							700	800	1500	2000	
		16									1000	1200	
		≥ 20											

- T : Total selectivity.
- 700 : Selectivity limit = 700 A
- : No selectivity.

[1] Type of circuit breaker depend on earthing system and circuit breaker ranges (see Distribution guide direct current CA908061).

[2] According to the voltage and number of pole used, the breaking capacity can be changed. Selectivity limit is the minimum of the value indicated in the table and the breaking capacity of downstream circuit breaker.

[3] This table is applicable for Case 1, Case 2, Case 3, Case 4 defined in introduction with this voltage between + and - Selectivity limits in this table for Case 3 and Case 4 can also apply to system with higher voltage (up to 2 times) for the same circuit breaker (same number of poles used).

Compliance of circuit breakers according to voltage and earthing system shall be checked before using this table.

# Selectivity table

Upstream: iC60 curve D

Downstream: iC60 curves B, C, D, C60H-DC curve C



Ue: 24-48-60 V DC <sup>[3]</sup>

Time constant: 1.5 ms - 25 ms

Upstream	iC60N/H/L, 1P or 2P <sup>[1]</sup>										
	Curve D										
In (A)	3	4	6	10	16	20	25	32	40	50	63

Downstream													
Circuit breaker	Curve	Rating (A)	Selectivity limit (A) <sup>[2]</sup>										
iC60N/H/L 1P or 2P <sup>[1]</sup>	B	≤ 1	T		T	T	T	T	T	T	T	T	T
		2		1500	T	T	T	T	T	T	T	T	T
		3			400	T	T	T	T	T	T	T	T
		4				700	T	T	T	T	T	T	T
		6					700	1000	2500	T	T	T	T
		10							700	1400	1600	3600	9000
		16								900	1000	1900	2700
		≥ 20											
	C	≤ 1	T	T	T	T	T	T	T	T	T	T	T
		2		1000	T	T	T	T	T	T	T	T	T
		3			350	T	T	T	T	T	T	T	T
		4				700	T	T	T	T	T	T	T
		6					700	1000	2000	T	T	T	T
		10							700	1400	1600	3600	9000
		16								900	1000	1500	2100
		≥ 20											
	D	≤ 1	T	T	T	T	T	T	T	T	T	T	T
		2		700	T	T	T	T	T	T	T	T	T
		3			350	T	T	T	T	T	T	T	T
		4				700	T	T	T	T	T	T	T
		6					700	1000	2000	T	T	T	T
10								700	1400	1600	3600	7400	
16									900	1000	1500	2100	
≥ 20													
C60H-DC 1P or 2P <sup>[1]</sup>	C	≤ 1	T	T	T	T	T	T	T	T	T	T	
		2		1000	T	T	T	T	T	T	T	T	
		3			350	T	T	T	T	T	T	T	
		4				700	T	T	T	T	T	T	
		6					700	1000	2000	T	T	T	
		10							700	1400	1600	3600	9000
		16								900	1000	1500	2100
		≥ 20											

- T : Total selectivity.
- 700 : Selectivity limit = 700 A
- : No selectivity.

[1] Type of circuit breaker depend on earthing system and circuit breaker ranges (see Distribution guide direct current CA908061).  
 [2] According to the voltage and number of pole used, the breaking capacity can be changed. Selectivity limit is the minimum of the value indicated in the table and the breaking capacity of downstream circuit breaker.  
 [3] This table is applicable for Case 1, Case 2, Case 3, Case 4 defined in introduction with this voltage between + and - Selectivity limits in this table for Case 3 and Case 4 can also apply to system with higher voltage (up to 2 times) for the same circuit breaker (same number of poles used).

Compliance of circuit breakers according to voltage and earthing system shall be checked before using this table.



# Selectivity table

Upstream: C60H-DC curve C

Downstream: iC60 curves B, C, D, C60H-DC curve C

Ue: 24-48-60 V DC [3]

Time constant: 1.5 ms - 25 ms



Upstream	C60H-DC, 1P or 2P [1]										
	Curve C										
In (A)	3	4	6	10	16	20	25	32	40	50	63

Downstream													
Circuit breaker	Curve	Rating (A)	Selectivity limit (A) [2]										
iC60N/H/L 1P or 2P [1]	B	≤ 1		T	T	T	T	T	T	T	T	T	
		2			150	T	T	T	T	T	T	T	
		3				300	1200	T	T	T	T	T	
		4					500	800	1500	T	T	T	
		6						370	450	900	1600	3600	7300
		10								400	800	1200	1800
		≥ 16											
	C	≤ 1		T	T	T	T	T	T	T	T	T	
		2			150	T	T	T	T	T	T	T	
		3				300	1200	T	T	T	T	T	
		4					400	600	1500	T	T	T	
		6						300	450	900	1600	3600	6000
		10								400	800	1200	1450
		≥ 16											
	D	≤ 1		T	T	T	T	T	T	T	T	T	
		2			150	T	T	T	T	T	T	T	
		3				200	900	T	T	T	T	T	
		4					400	600	1500	T	T	T	
		6						300	450	900	1600	3600	6000
		10								400	700	1200	1450
		≥ 16											
	C60H-DC 1P or 2P [1]	C	≤ 1		T	T	T	T	T	T	T	T	
			2			150	T	T	T	T	T	T	
			3				300	1200	T	T	T	T	
4							500	800	1500	T	T		
6								370	450	900	1600	3600	7300
10										400	800	1200	1800
≥ 16													

: Total selectivity.

: Selectivity limit = 700 A

: No selectivity.

[1] Type of circuit breaker depend on earthing system and circuit breaker ranges (see Distribution guide direct current CA908061).

[2] According to the voltage and number of pole used, the breaking capacity can be changed. Selectivity limit is the minimum of the value indicated in the table and the breaking capacity of downstream circuit breaker.

[3] This table is applicable for Case 1, Case 2, Case 3, Case 4 defined in introduction with this voltage between + and - Selectivity limits in this table for Case 3 and Case 4 can also apply to system with higher voltage (up to 2 times) for the same circuit breaker (same number of poles used).

Compliance of circuit breakers according to voltage and earthing system shall be checked before using this table.

# Selectivity table

Upstream: C120, NG125 curve B

Downstream: iC60 curves B, C, D, C60H-DC curve C



Ue: 24-48-60 V DC <sup>[3]</sup>

Time constant: 1.5 ms - 25 ms

Upstream	C120N/H/L, NG125N/H/L, 1P or 2P <sup>[1]</sup>										
	Curve B										
In (A)	10	16	20	25	32	40	50	63	80	100	125

Downstream												
Circuit breaker	Curve	Rating (A)	Selectivity limit (A) <sup>[2]</sup>									
iC60N/H/L 1P or 2P <sup>[1]</sup>	B	≤ 2	T	T	T	T	T	T	T	T	T	T
		3	150	T	T	T	T	T	T	T	T	T
		4		300	500	1000	1250	T	T	T	T	T
		6			300	500	600	1800	2000	5500	T	T
		10						700	700	1900	5000	9500
		16									2000	3500
		20										2000
		≥ 25										
	C	≤ 2	T	T	T	T	T	T	T	T	T	T
		3	120	T	T	T	T	T	T	T	T	
		4		250	900	1100	1300	T	T	T	T	
		6				500	500	1400	2000	4500	T	
		10						500	600	1500	5000	
		16									1800	
		20										
		≥ 25										
	D	≤ 1	T	T	T	T	T	T	T	T	T	
		2	5000	T	T	T	T	T	T	T		
		3		600	T	T	T	T	T	T		
		4			500	800	1000	T	T	T		
		6				300	300	1100	1600	3500		
		10						400	400	1200		
		16							250	400		
		≥ 25										
	C60H-DC 1P or 2P <sup>[1]</sup>	C	≤ 2	T	T	T	T	T	T	T	T	
			3	120	T	T	T	T	T	T		
			4		250	900	1100	1300	T	T		
6						500	500	1400	2000			
10								500	600			
16												
20												
≥ 25												

- T : Total selectivity.
- 700 : Selectivity limit = 700 A
- : No selectivity.

[1] Type of circuit breaker depend on earthing system and circuit breaker ranges (see Distribution guide direct current CA908061).

[2] According to the voltage and number of pole used, the breaking capacity can be changed. Selectivity limit is the minimum of the value indicated in the table and the breaking capacity of downstream circuit breaker.

[3] This table is applicable for Case 1, Case 2, Case 3, Case 4 defined in introduction with this voltage between + and - Selectivity limits in this table for Case 3 and Case 4 can also apply to system with higher voltage (up to 2 times) for the same circuit breaker (same number of poles used).

Compliance of circuit breakers according to voltage and earthing system shall be checked before using this table.

# Selectivity table

Upstream: C120, NG125 curve C

Downstream: iC60 curves B, C, D, C60H-DC curve C

Ue: 24-48-60 V DC [3]

Time constant: 1.5 ms - 25 ms



Upstream	C120N/H/L, NG125N/H/L, 1P or 2P [1]											
	Curve C											
In (A)	10	16	20	25	32	40	50	63	80	100	125	

Downstream													
Circuit breaker	Curve	Rating (A)	Selectivity limit (A) [2]										
iC60N/H/L 1P or 2P [1]	B	≤ 2	T	T	T	T	T	T	T	T	T	T	T
		3	5000	T	T	T	T	T	T	T	T	T	T
		4		1500	2000	T	T	T	T	T	T	T	T
		6			400	1500	3000	T	T	T	T	T	T
		10						1800	3000	8000	T	T	T
		16						1000	1400	2500	15000	T	T
		20									6500	11500	T
		25									4500	8500	15000
		32										5000	8000
		≥ 40											
	C	≤ 2	T	T	T	T	T	T	T	T	T	T	T
		3	5000	T	T	T	T	T	T	T	T	T	T
		4		1000	1400	T	T	T	T	T	T	T	T
		6			400	1000	2400	T	T	T	T	T	T
		10					800	1500	3000	8500	T	T	T
		16						800	1400	3000	15000	T	T
		20								1700	6500	11000	T
		25									4500	8500	12000
		32									3000	5000	7000
		≥ 40											
	D	≤ 2	T	T	T	T	T	T	T	T	T	T	T
		3	4000	T	T	T	T	T	T	T	T	T	T
		4		500	1000	T	T	T	T	T	T	T	T
		6				800	1900	T	T	T	T	T	T
		10					600	1200	2500	7000	T	T	T
		16						500	1000	2500	12000	T	T
		20								1400	5500	9000	T
		25									3500	7500	11000
		32										3500	6000
		≥ 40											
C60H-DC 1P or 2P [1]	C	≤ 2	T	T	T	T	T	T	T	T	T	T	
		3	5000	T	T	T	T	T	T	T	T	T	
		4		1000	1400	T	T	T	T	T	T	T	
		6			400	1000	2400	T	T	T	T	T	
		10					800	1500	3000	8500	T	T	T
		16						800	1400	3000	15000	T	T
		20								1700	6500	11000	T
		25									4500	8500	12000
		32									3000	5000	7000
		≥ 40											

T : Total selectivity.

500 : Selectivity limit = 700 A

  : No selectivity.

[1] Type of circuit breaker depend on earthing system and circuit breaker ranges (see Distribution guide direct current CA908061).

[2] According to the voltage and number of pole used, the breaking capacity can be changed. Selectivity limit is the minimum of the value indicated in the table and the breaking capacity of downstream circuit breaker.

[3] This table is applicable for Case 1, Case 2, Case 3, Case 4 defined in introduction with this voltage between + and - Selectivity limits in this table for Case 3 and Case 4 can also apply to system with higher voltage (up to 2 times) for the same circuit breaker (same number of poles used).

Compliance of circuit breakers according to voltage and earthing system shall be checked before using this table.

# Selectivity table

Upstream: C120, NG125 curve D

Downstream: iC60 curves B, C, D, C60H-DC curve C



Ue: 24-48-60 V DC <sup>[3]</sup>

Time constant: 1.5 ms - 25 ms

Upstream	C120N/H/L, NG125N/H/L, 1P or 2P <sup>[1]</sup>										
	Curve D										
In (A)	10	16	20	25	32	40	50	63	80	100	125

Downstream													
Circuit breaker	Curve	Rating (A)	Selectivity limit (A) <sup>[2]</sup>										
iC60N/H/L 1P or 2P <sup>[1]</sup>	B	≤ 3	T	T	T	T	T	T	T	T	T	T	
		4	5000	T	T	T	T	T	T	T	T	T	
		6		1000	2000	T	T	T	T	T	T	T	
		10			1000	9000	1400	3500	5000	T	T	T	
		16						1500	2500	6000	T	T	
		20							2000	3500	T	T	
		25									15000	T	T
		32									9000	T	T
		40									7000	10000	T
		50											10000
		63											5000
		C	≤ 3	T	T	T	T	T	T	T	T	T	T
	4		5000	T	T	T	T	T	T	T	T	T	
	6			1000	2000	T	T	T	T	T	T	T	
	10				1000	9000	1400	3000	4000	15000	T	T	
	16							1500	2000	6000	T	T	
	20									3000	T	T	
	25										12000	T	T
	32										8000	T	T
	40										5000	9000	T
	50												9000
	63												4000
	D		≤ 3	T	T	T	T	T	T	T	T	T	T
		4	5000	T	T	T	T	T	T	T	T	T	
		6		1000	2000	T	T	T	T	T	T	T	
		10			1000	9000	1400	3000	4000	12000	T	T	
		16						1200	2000	5000	T	T	
		20									T	T	
		25									10000	T	T
		32									6000	12000	T
40											5000	10000	
50												5000	
63													
C60H-DC 1P or 2P <sup>[1]</sup>		C	≤ 3	T	T	T	T	T	T	T	T	T	
	4		5000	T	T	T	T	T	T	T	T	T	
	6			1000	2000	T	T	T	T	T	T	T	
	10				1000	9000	1400	3000	4000	15000	T	T	
	16							1500	2000	6000	T	T	
	20									3000	T	T	
	25										12000	T	T
	32										8000	T	T
	40										5000	9000	T
	50												9000
	63												4000

- T : Total selectivity.
- 5000 : Selectivity limit = 700 A
- : No selectivity.

<sup>[1]</sup> Type of circuit breaker depend on earthing system and circuit breaker ranges (see Distribution guide direct current CA908061).  
<sup>[2]</sup> According to the voltage and number of pole used, the breaking capacity can be changed.  
 Selectivity limit is the minimum of the value indicated in the table and the breaking capacity of downstream circuit breaker.  
<sup>[3]</sup> This table is applicable for Case 1, Case 2, Case 3, Case 4 defined in introduction with this voltage between + and -  
 Selectivity limits in this table for Case 3 and Case 4 can also apply to system with higher voltage (up to 2 times) for the same circuit breaker (same number of poles used).

Compliance of circuit breakers according to voltage and earthing system shall be checked before using this table.

# Selectivity table

Upstream: Compact NSX100/160/250 DC TM-D, TM-DC

Downstream: iC60, C120, NG125. C60H-DC

Ue: 24-48-60 V DC [3]

Time constant: 1.5 ms - 25 ms



Upstream	NSX100DC								NSX160DC				NSX250 DC				
	1P1D 2P2D F/N/M/S 3P3D F/S [1]																
	Trip unit	TMD, TM-DC								TMD, TM-DC				TM-DC			
	Rating	16	25	32	40	50	63	80	100	100	125	160	160	200	250		
Im		fixed	fixed	fixed	fixed	fixed	fixed	fixed	fixed	fixed	fixed	fixed	Mini	Maxi	Mini	Maxi	
	260	400	550	700	700	700	800	800	800	800	1250	1250	1250	1000	2000	1250	2500

Downstream	Rating	Selectivity limit (kA) [2]															
<b>iC60 N/H</b> B-C-D curves	0.5	T	T	T	T	T	T	T	T	T	T	T	T	T	T	T	T
	1	T	T	T	T	T	T	T	T	T	T	T	T	T	T	T	T
<b>iC60 L</b> B-C-D curves	2	10	T	T	T	T	T	T	T	T	T	T	T	T	T	T	T
	3	5	10	T	T	T	T	T	T	T	T	T	T	T	T	T	T
<b>1P1D or 2P2D</b> [1]	4	0.26	5	10	T	T	T	T	T	T	T	T	T	T	T	T	T
	5		0.4	5	10	T	T	T	T	T	T	T	T	T	T	T	T
	6			0.55	5	10	T	T	T	T	T	T	T	T	T	T	T
	10				0.7	5	T	T	T	T	T	T	T	T	T	T	T
	13					0.7	T	T	T	T	T	T	T	T	T	T	T
	15-16						5	T	T	T	T	T	T	T	T	T	T
	20						0.7	10	10	10	T	T	T	T	T	T	T
	25							5	10	10	T	T	T	T	T	T	T
	32							0.8	10	10	T	T	T	10	T	T	T
	40								5	5	10	T	T	5	T	T	T
50								0.8	0.8	10	10	10		T	10	T	
63										5	5	5		T	5	T	
<b>C60H-DC</b> C curves	0.5	T	T	T	T	T	T	T	T	T	T	T	T	T	T	T	T
	1	T	T	T	T	T	T	T	T	T	T	T	T	T	T	T	T
<b>1P1D or 2P2D</b> [1]	2	10	T	T	T	T	T	T	T	T	T	T	T	T	T	T	T
	3	5	10	T	T	T	T	T	T	T	T	T	T	T	T	T	T
	4	0.26	5	10	T	T	T	T	T	T	T	T	T	T	T	T	T
	5		0.4	5	10	T	T	T	T	T	T	T	T	T	T	T	T
	6			0.55	5	10	T	T	T	T	T	T	T	T	T	T	T
	10				0.7	5	T	T	T	T	T	T	T	T	T	T	T
	13					0.7	T	T	T	T	T	T	T	T	T	T	T
	15-16						5	T	T	T	T	T	T	T	T	T	T
	20						0.7	10	10	10	T	T	T	T	T	T	T
	25							5	10	10	T	T	T	T	T	T	T
30-32							0.8	10	10	T	T	T	10	T	T	T	
40								5	5	10	T	T	5	T	T	T	
50								0.8	0.8	10	10	10		T	10	T	
63										5	5	5		T	5	T	
<b>C120 N/H</b> B-C-D curves	63									1.25	5	5		5	T	T	
	80													5		T	
<b>1P1D or 2P2D</b> [1]	100													5		T	
	125															T	
	10		0.4	0.5	0.7	0.7	0.7	5	5	5	10	10	10	T	T	T	T
	16			0.5	0.7	0.7	0.7	0.8	5	5	10	10	10	10	T	T	T
	20				0.7	0.7	0.7	0.8	0.8	0.8	10	10	10	5	T	T	T
	25					0.7	0.7	0.8	0.8	0.8	10	10	10	5	T	T	T
	32						0.7	0.8	0.8	0.8	10	10	10	1	T	T	T
	40							0.8	0.8	0.8	5	10	10	1	T	T	T
	50								0.8	0.8	5	10	10	1	T	T	T
	63										1.25	5	5	1	10	T	T
80										1.25	5	5		5	T	T	
100 (N)														5		T	
125 (N)																T	

[1] Type of circuit breaker depend on earthing system and circuit breaker ranges (see Distribution guide direct current CA908061).

[2] According to the voltage and number of pole used, the breaking capacity can be changed.

Selectivity limit is the minimum of the value indicated in the table and the breaking capacity of downstream circuit breaker.

[3] This table is applicable for Case 1, Case 2, Case 3, Case 4 defined in introduction with this voltage between + and -

Selectivity limits in this table for Case 3 and Case 4 can also apply to system with higher voltage (up to 2 times) for the same circuit breaker (same number of poles used).

Compliance of circuit breakers according to voltage and earthing system shall be checked before using this table.

# Selectivity table

Upstream: Compact NSX100/160/250 DC with parallel connection of poles

Downstream: iC60, C60H-DC, C120, NG125

Ue: 24-48-60 V DC <sup>[3]</sup>

Time constant: 1.5 ms - 25 ms

A

Upstream	NSX 100DC F			NSX 160DC F		NSX 250 DC F			NSX 100DC F			NSX 160DC F		NSX 250DC F		
	2P2D					3P3D 2P used			4P4D							
	Parallel connection for + or -					Parallel connection for + or -			2 poles with parallel connection for + and - <sup>[2]</sup>							
	Trip unit	TM-D, TM-DC					TM-DC			TM-D, TM-DC			TM-DC			
Rating	50	63	80	125	160	200	160	200	50	63	80	125	160	200		
Equivalent rated current	125	158	200	313	400	500			115	145	184	288	368	460		
Im	fixed	fixed	fixed	fixed	fixed	Mini	Maxi	fixed	fixed	fixed	fixed	fixed	fixed	Mini	Maxi	
	1400	1400	1600	2500	2500	2000	4000	1400	1400	1600	2500	2500	2500	2000	4000	

Downstream	Rating	Selectivity limit (kA) <sup>[2]</sup>														
iC60 N / H B-C-D Curves	0.5	T	T	T	T	T	T	T	T	T	T	T	T	T	T	T
	1	T	T	T	T	T	T	T	T	T	T	T	T	T	T	T
iC60 L B-C-D-curves	2	T	T	T	T	T	T	T	T	T	T	T	T	T	T	T
	3	T	T	T	T	T	T	T	T	T	T	T	T	T	T	T
1P1D or 2P2D <sup>[1]</sup>	4	T	T	T	T	T	T	T	T	T	T	T	T	T	T	T
	5	T	T	T	T	T	T	T	T	T	T	T	T	T	T	T
	6	T	T	T	T	T	T	T	T	T	T	T	T	T	T	T
	10	T	T	T	T	T	T	T	T	T	T	T	T	T	T	T
	13	T	T	T	T	T	T	T	T	T	T	T	T	T	T	T
	15-16	T	T	T	T	T	T	T	T	T	T	T	T	T	T	T
	20	10	T	T	T	T	T	T		T	T	T	T	T	T	T
	25	5	T	T	T	T	T	T	5	T	T	T	T	T	T	T
	32	0.8	T	T	T	T	T	T	0.8	T	T	T	T	T	T	T
	40		10	T	T	T	T	T		10	T	T	T	T	T	T
	50		10	10	T	T	10	T		10	10	T	T	10	T	
63		5	5	T	T	5	T		5	5	T	T	5	T		
C60H-DC C Curves	0.5	T	T	T	T	T	T	T	T	T	T	T	T	T	T	T
	1	T	T	T	T	T	T	T	T	T	T	T	T	T	T	T
	2	T	T	T	T	T	T	T	T	T	T	T	T	T	T	T
	3	T	T	T	T	T	T	T	T	T	T	T	T	T	T	T
	4	T	T	T	T	T	T	T	T	T	T	T	T	T	T	T
	5	T	T	T	T	T	T	T	T	T	T	T	T	T	T	T
	6	T	T	T	T	T	T	T	T	T	T	T	T	T	T	T
	10	T	T	T	T	T	T	T	T	T	T	T	T	T	T	T
	13	T	T	T	T	T	T	T	T	T	T	T	T	T	T	T
	15-16	T	T	T	T	T	T	T	T	T	T	T	T	T	T	T
	20	10	T	T	T	T	T	T	10	T	T	T	T	T	T	T
25	5	T	T	T	T	T	T	5	T	T	T	T	T	T	T	
30-32	0.8	T	T	T	T	T	T	0.8	T	T	T	T	T	T	T	
40		10	T	T	T	T	T		10	T	T	T	T	T	T	
50		10	10	T	T	10	T		10	10	T	T	10	T		
63		5	5	T	T	5	T		5	5	T	T	5	T		
C120 N/H B-C-D Curves	63		1.25	5	T	T	T		1.25	5	T	T	T	T	T	
	80				T	T	T				T	T	T	T	T	
	100				T	T	T				T	T	T	T	T	
	125				T	T	T				T	T	T	T	T	
NG125 N/H/L B-C-D Curves	10	5	10	10	T	T	T	5	10	10	T	T	T	T	T	
	16	0.8	10	10	T	T	T	0.8	10	10	T	T	T	T	T	
	20	0.8	10	10	T	T	T	0.8	10	10	T	T	T	T	T	
	25	0.8	10	10	T	T	T	0.8	10	10	T	T	T	T	T	
	32	0.8	5	10	T	T	T	0.8	5	10	T	T	T	T	T	
	40		5	10	T	T	T		5	10	T	T	T	T	T	
	50		1.25	5	T	T	T		1.25	5	T	T	T	T	T	
	63		1.25	5	T	T	T		1.25	5	T	T	T	T	T	
	80				T	T	T				T	T	T	T	T	
	100 (N)				T	T	T				T	T	T	T	T	
	125 (N)				T	T	T				T	T	T	T	T	

[1] Type of circuit breaker (1P1D, 2P2D) depend on earthing system and circuit breaker ranges.  
 For voltage up to 60Vdc one single pole of iC60 C120 NG125 NSX range is enough to break the current.  
 For ranges with 3P or 4P breakers only (NSX250 for example), one or two poles only are used of a 3P circuit breaker.

[2] According to the voltage and nb of pole used, the breaking capacity can be changed.  
 Selectivity limit is the minimum of the value indicated in the table and the breaking capacity of downstream circuit breaker.

[3] This table is applicable for Case 1, Case 2, Case 3, Case 4 defined in introduction with this voltage between + and -.  
 Selectivity limits in this table for case 1 and Case 3 can also apply to system with higher voltage (up to 2 times) for the same circuit breaker (same number of poles used).

Compliance of circuit breakers according to voltage and earthing system shall be checked before using this table.

# Selectivity table

Upstream: Compact NSX100/160/250 DC TM-G

Downstream: iC60, C60H-DC, C120, NG125

U<sub>e</sub>: 24-48-60 V DC <sup>[3]</sup>

Time constant: 1.5 ms - 25 ms

A

Upstream	NSX100DC						NSX160DC			NSX250 DC			
	3P3D (1 or 2 P used) F/S <sup>[1]</sup>												
	Trip unit	TM-G						TM-G			TM-G		
	Rating	16	25	40	63	80	100	100	125	160	160	200	250
I <sub>m</sub>	80	100	100	150	250	400	400	530	530	530	530	625	

Downstream	In	Selectivity limit (kA) <sup>[2]</sup>												
iC60 N/H/L B-C-D Curves	0.5	10	10	10	T	T	T	T	T	T	T	T	T	
	1	5	5	5	T	T	T	T	T	T	T	T	T	
	2	0.08	0.1	0.1	10	T	T	T	T	T	T	T	T	
	3			0.1	5	10	T	T	T	T	T	T	T	
	4				0.15	5	10	10	T	T	T	T	T	
	1P1D or 2P2D <sup>[1]</sup>	5					0.25	5	5	T	T	T	T	T
		6						0.4	0.4	T	T	T	T	T
		10								10	10	10	10	T
		13								5	5	5	5	10
		15-16								5	5	5	5	5
		20								0.5	0.5	0.5	0.5	5
		25												0.6
		32												
		40												
50														
63														
C60H-DC C Curves	0.5	10	10	10	T	T	T	T	T	T	T	T	T	
	1	5	5	5	T	T	T	T	T	T	T	T	T	
	2	0.08	0.1	0.1	10	T	T	T	T	T	T	T	T	
	1P1D or 2P2D <sup>[1]</sup>	3			0.1	5	10	T	T	T	T	T	T	T
		4				0.15	5	10	10	T	T	T	T	T
		5					0.25	5	5	T	T	T	T	T
		6						0.4	0.4	T	T	T	T	T
		10								10	10	10	10	T
		13								5	5	5	5	10
		15-16								5	5	5	5	5
		20								5	5	5	5	5
		25								0.5	0.5	0.5	0.5	5
		30-32												0.6
	40													
50														
63														
NG125 N/H/L B-C-D Curves	10					0.25	0.4	0.4	0.5	0.5	0.5	0.5	0.6	
	16						0.4	0.5	0.5	0.5	0.5	0.5	0.6	
	20								0.5	0.5	0.5	0.5	0.6	
	1P1D or 2P2D <sup>[1]</sup>	25												0.6
		32												
40														

**[1]** Type of circuit breaker (1P1D, 2P2D) depend on earthing system and circuit breaker ranges.

For voltage up to 60Vdc one single pole of iC60 C120 NG125 NSX range is enough to break the current.

For ranges with 3P or 4P breakers only (NSX250 for example), one or two poles only are used of a 3P circuit breaker.

**[2]** According to the voltage and nb of pole used, the breaking capacity can be changed.

Selectivity limit is the minimum of the value indicated in the table and the breaking capacity of downstream circuit breaker.

**[3]** This table is applicable for Case 1, Case 2, Case 3, Case 4 defined in introduction with this voltage between + and -.

Selectivity limits in this table for case 1 and Case 3 can also apply to system with higher voltage (up to 2 times) for the same circuit breaker (same number of poles used).

Compliance of circuit breakers according to voltage and earthing system shall be checked before using this table.

# Selectivity table

Upstream: Compact NSX100/160/250 DC TM-D, TM-DC

Downstream: Compact NSX100/160 DC TM-D, TM-DC, TM-G

Ue: 24-48-60 V DC <sup>[3]</sup>

Time constant: 1.5 ms - 25 ms

A

Upstream	NSX100 DC								NSX160 DC				NSX250 DC				
	1P1D 2P2D F/N/M/S (3P3D F/S) <sup>[1]</sup>																
	Trip unit	TM-D								TM-D, TM-DC				TM-DC			
	Rating	16	25	32	40	50	63	80	100	100	125	160	160	200	250		
Im	fixed	fixed	fixed	fixed	fixed	fixed	fixed	fixed	fixed	fixed	fixed	fixed	Mini	Maxi	Mini	Maxi	
	260	400	550	700	700	700	640	800	800	1250	1250	1250	1000	2000	1250	2500	

Downstream	Rating	Im	Selectivity limit (kA) <sup>[2]</sup>															
<b>NSX100DC</b>	16	260			0.5	0.7	0.7	0.7	0.7	0.8	0.8	1.25	1.25	1.25	1	2	1.25	5
<b>TM-D</b>	25	400				0.7	0.7	0.7	0.7	0.8	0.8	1.25	1.25	1.25	1	2	1.25	5
<b>(TM-DC)</b>	32	400						0.7	0.7	0.8	0.8	1.25	1.25	1.25	1	2	1.25	5
<b>1P1D or 2P2PD (3P3D)</b>	40	700							0.7	0.8	0.8	1.25	1.25	1.25	1	2	1.25	5
	50	700							0.7	0.8	0.8	1.25	1.25	1.25	1	2	1.25	2.5
<sup>[1]</sup>	63	700								0.8	0.8	1.25	1.25	1.25	1	2	1.25	2.5
	80	800										1.25	1.25	1.25	1	2	1.25	2.5
	100	1000										1.25	1.25	1.25	1	2	1.25	2.5
<b>NSX100DC</b>	16	80			0.5	0.7	0.7	0.7	0.7	0.8	0.8	1.25	1.25	1.25	1	2	1.25	10
<b>TM-G</b>	25	100				0.7	0.7	0.7	0.7	0.8	0.8	1.25	1.25	1.25	1	2	1.25	5
<b>3P3D</b>	40	100							0.7	0.8	0.8	1.25	1.25	1.25	1	2	1.25	5
<sup>[1]</sup>	63	150							0.7	0.8	0.8	1.25	1.25	1.25	1	2	1.25	5
	80	250								0.8		1.25	1.25	1.25	1	2	1.25	2.5
	100	400										1.25	1.25	1.25	1	2	1.25	2.5
<b>NSX160DC</b>	100	1000										1.25	1.25	1.25	1	2	1.25	2.5
<b>1P1D or 2P2D</b>	125	1200															1.25	2.5
<b>3P2D <sup>[1]</sup></b>	160	1250																
<b>NSX160DC</b>	125	530															1.25	2.5
<b>TM-G 3P3D <sup>[1]</sup></b>	160	530																

[1] Type of circuit breaker (1P1D, 2P2D) depend on earthing system and circuit breaker ranges.

For voltage up to 60Vdc one single pole of iC60 C120 NG125 NSX range is enough to break the current.

For ranges with 3P or 4P breakers only (NSX250 for example), one or two poles only are used of a 3P circuit breaker.

[2] According to the voltage and nb of pole used, the breaking capacity can be changed.

Selectivity limit is the minimum of the value indicated in the table and the breaking capacity of downstream circuit breaker.

[3] This table is applicable for Case 1, Case 2, Case 3, Case 4 defined in introduction with this voltage between + and -.

Selectivity limits in this table for case 1 and Case 3 can also apply to system with higher voltage (up to 2 times) for the same circuit breaker (same number of poles used).

Compliance of circuit breakers according to voltage and earthing system shall be checked before using this table.



# Selectivity table

Upstream: Compact NSX400/630/1200 DC TM-DC

Downstream: iC60, C60H-DC, C120, NG125

Ue: 24-48-60 V DC [3]

Time constant: 1.5 ms - 25 ms



Upstream	NSX400DC F/S						NSX630DC F/S				NSX1200DC N							
	3P3D (1 or 2 P Used) [1]										2P2D							
	TM-DC						TM-DC				TM-DC							
	Trip unit	250		320		400		500		600		630		800		1000		1200
Rating	min	max	min	max	min	max	min	max	min	max	min	max	min	max	min	max	min	max
Im	625	1250	800	1600	1000	2000	1250	2500	1500	3000	1575	3150	2000	4000	2500	5000	3000	6000

Downstream Rating	Selectivity limit (kA) [2]																	
<b>iC60 N/H/L</b>	0.5	T	T	T	T	T	T	T	T	T	T	T	T	T	T	T	T	T
<b>B-C-D Curves</b>	1	T	T	T	T	T	T	T	T	T	T	T	T	T	T	T	T	T
	2	T	T	T	T	T	T	T	T	T	T	T	T	T	T	T	T	T
	3	T	T	T	T	T	T	T	T	T	T	T	T	T	T	T	T	T
	4	T	T	T	T	T	T	T	T	T	T	T	T	T	T	T	T	T
<b>1P1D or 2P2D</b>	5	T	T	T	T	T	T	T	T	T	T	T	T	T	T	T	T	T
[1]	6	T	T	T	T	T	T	T	T	T	T	T	T	T	T	T	T	T
	10	10	T	10	T	T	T	T	T	T	T	T	T	T	T	T	T	T
	13	5	T	10	T	T	T	T	T	T	T	T	T	T	T	T	T	T
	15-16	0.6	T	5	T	10	T	T	T	T	T	T	T	T	T	T	T	T
	20		10	5	T	5	T	T	T	T	T	T	T	T	T	T	T	T
	25		5	0.8	10	5	T	T	T	T	T	T	T	T	T	T	T	T
	32		1.25	0.8	10	1	10	T	T	T	T	T	T	T	T	T	T	T
	40				10		10	T	T	T	T	T	T	T	T	T	T	T
	50				5		5	T	T	T	T	T	T	T	T	T	T	T
	63				5		2	T	T	T	T	T	T	T	T	T	T	T
<b>C60H-DC</b>	0.5	T	T	T	T	T	T	T	T	T	T	T	T	T	T	T	T	T
<b>C Curves</b>	1	T	T	T	T	T	T	T	T	T	T	T	T	T	T	T	T	T
	2	T	T	T	T	T	T	T	T	T	T	T	T	T	T	T	T	T
<b>1P1D or 2P2D</b>	3	T	T	T	T	T	T	T	T	T	T	T	T	T	T	T	T	T
[1]	4	T	T	T	T	T	T	T	T	T	T	T	T	T	T	T	T	T
	5	T	T	T	T	T	T	T	T	T	T	T	T	T	T	T	T	T
	6	T	T	T	T	T	T	T	T	T	T	T	T	T	T	T	T	T
	10	10	T	10	T	T	T	T	T	T	T	T	T	T	T	T	T	T
	13	5	T	10	T	T	T	T	T	T	T	T	T	T	T	T	T	T
	15-16	0.6	T	5	T	10	T	T	T	T	T	T	T	T	T	T	T	T
	20		10	5	T	5	T	T	T	T	T	T	T	T	T	T	T	T
	25		5	0.8	10	5	T	T	T	T	T	T	T	T	T	T	T	T
	30-32		1.25	0.8	10	1	10	T	T	T	T	T	T	T	T	T	T	T
	40				10		10	T	T	T	T	T	T	T	T	T	T	T
	50				5		5	T	T	T	T	T	T	T	T	T	T	T
	63				5		2	T	T	T	T	T	T	T	T	T	T	T
<b>C120 N/H</b>	63							T	1.5	T	1.5	T	5	T	T	T	T	T
	80							T		T		T	2	T	T	T	T	T
<b>1P1D or 2P2D</b>	100 (N)							T		T		T		T	T	T	T	T
[1]	125 (N)							5		T		T		5	T	T	T	T
<b>NG125 N/H/L</b>	10	0.625	5	5	10	5	10	T	T	T	T	T	T	T	T	T	T	T
<b>B-C-D Curves</b>	16		1.25	0.8	10	5	10	T	T	T	T	T	T	T	T	T	T	T
	20				5	1	10	T	T	T	T	T	T	T	T	T	T	T
<b>1P1D or 2P2D</b>	25				5	1	5	10	T	T	T	T	T	T	T	T	T	T
[1]	32				1.6	1	5	5	T	10	T	10	T	T	T	T	T	T
	40						2	5	T	5	T	5	T	T	T	T	T	T
	50							1.25	T	5	T	5	T	10	T	T	T	T
	63								T	1.5	T	1.5	T	5	T	T	T	T
	80								T		T		T	2	T	T	T	T
	100 (N)								T		T		T		T	T	T	T
	125 (N)								5		T		T		5	T	T	T

[1] Type of circuit breaker (1P1D, 2P2D) depend on earthing system and circuit breaker ranges.

For voltage up to 60Vdc one single pole of iC60 C120 NG125 NSX range is enough to break the current.

For ranges with 3P or 4P breakers only (NSX250 for example), one or two poles only are used of a 3P circuit breaker.

[2] According to the voltage and nb of pole used, the breaking capacity can be changed.

Selectivity limit is the minimum of the value indicated in the table and the breaking capacity of downstream circuit breaker.

[3] This table is applicable for Case 1, Case 2, Case 3, Case 4 defined in introduction with this voltage between + and -.

Selectivity limits in this table for case 1 and Case 3 can also apply to system with higher voltage (up to 2 times) for the same circuit breaker (same number of poles used).

Compliance of circuit breakers according to voltage and earthing system shall be checked before using this table.

# Selectivity table

Upstream: Compact NSX400/630/1200 DC TM-DC

Downstream: Compact NSX100/160/250 DC TM-D, TM-DC, TM-G

U<sub>e</sub>: 24-48-60 V DC <sup>[3]</sup>

Time constant: 1.5 ms - 25 ms

A

Upstream	NSX400DC F/S						NSX630DC F/S				NSX1200DC N										
	3P3D (1 or 2 P Used) <sup>[1]</sup>																				
	Trip unit		TM-DC						TM-DC				TM-DC								
	Rating		250		320		400		500		600		630		800		1000		1200		
Im		min	max	min	max	min	max	min	max	min	max	min	max	min	max	min	max	min	max		
		625	1250	800	1600	1000	2000	1250	2500	1500	3000	1575	3150	2000	4000	2500	5000	3000	6000		
Downstream	Rating	Im	Selectivity limit (kA) <sup>[2]</sup>																		
NSX100DC	16	260	0.63	1.25	0.8	1.6	1	2	1.25	2.5	1.5	3	1.5	3.1	2	4	2.5	5	3	T	
	TM-D	25	400		1.25	0.8	1.6	1	2	1.25	2.5	1.5	3	1.5	3.1	2	4	2.5	5	3	10
		(TM-DC)	32	400			1.6	1	2	1.25	2.5	1.5	3	1.5	3.1	2	4	2.5	5	3	6
	1P1D or 2P2PD (3P3D)	40	700			1.6	1	2	1.25	2.5	1.5	3	1.5	3.1	2	4	2.5	5	3	6	
		50	700			1.6	1	2	1.25	2.5	1.5	3	1.5	3.1	2	4	2.5	5	3	6	
	<sup>[1]</sup>	63	700			1.6	1	2	1.25	2.5	1.5	3	1.5	3.1	2	4	2.5	5	3	6	
		80	800				1	2		2.5		3	1.5	3.1	2	4	2.5	5	3	6	
	100	1000					2		2.5		3		3.1	2	4	2.5	5	3	6		
NSX100DC	16	80	0.63	1.25	0.8	1.6	1	2	1.25	2.5	1.5	3	1.5	3.1	2	4	2.5	5	3	T	
	TM-G	25	100	0.63	1.25	0.8	1.6	1	2	1.25	2.5	1.5	3	1.5	3.1	2	4	2.5	5	3	10
		3P3P	40	100	0.63	1.25	0.8	1.6	1	2	1.25	2.5	1.5	3	1.5	3.1	2	4	2.5	5	3
	<sup>[1]</sup>	63	150	0.63	1.25	0.8	1.6	1	2	1.25	2.5	1.5	3	1.5	3.1	2	4	2.5	5	3	6
		80	250	0.63	1.25	0.8	1.6	1	2		2.5		3	1.5	3.1	2	4	2.5	5	3	6
	100	400			0.8	1.6	1	2		2.5		3	1.5	3.1	2	4	2.5	5	3	6	
NSX160DC	100	1000						2		2.5		3	1.5	3.1	2	4	2.5	5	3	6	
	TM-DC	125	1200							2.5		3		3.1		4	2.5	5	3	6	
		1P1D or 2P2PD	160	1250							2.5		3		3.1		4	2.5	5	3	6
NSX160DC	125	530							2.5	1.5	3	1.5	3.1	2	4	2.5	5	3	6		
	TM-G 3P3D	160	530						2.5	1.5	3	1.5	3.1	2	4	2.5	5	3	6		
NSX250DC	200	1000							2.5	1.5	3	1.5	3.1	2	4	2.5	5	3	6		
	TM-DC		2000								3		3.1		4	2.5	5	3	6		
		3P3D <sup>[1]</sup>	250	1250										3.1		4	2.5	5	3	6	
		2500											3.1		4		5	3	6		
NSX250DC	200	530							1.25	2.5	1.5	3	1.5	3.1	2	4	2.5	5	3	6	
	TM-G 3P3D	250	625						1.25	2.5	1.5	3	1.5	3.1	2	4	2.5	5	3	6	

[1] Type of circuit breaker (1P1D, 2P2D) depend on earthing system and circuit breaker ranges.

For voltage up to 60Vdc one single pole of iC60 C120 NG125 NSX range is enough to break the current.

For ranges with 3P or 4P breakers only (NSX250 for example), one or two poles only are used of a 3P circuit breaker.

[2] According to the voltage and nb of pole used, the breaking capacity can be changed.

Selectivity limit is the minimum of the value indicated in the table and the breaking capacity of downstream circuit breaker.

[3] This table is applicable for Case 1, Case 2, Case 3, Case 4 defined in introduction with this voltage between + and -.

Selectivity limits in this table for case 1 and Case 3 can also apply to system with higher voltage (up to 2 times) for the same circuit breaker (same number of poles used).

Compliance of circuit breakers according to voltage and earthing system shall be checked before using this table.

# Selectivity table

Upstream: Masterpact NW DC

Downstream: iC60, C60H-DC, C120, NG125. Compact NSX100/160/250

Ue: 24-48-60 V DC <sup>[3]</sup>

Time constant: 1.5 ms - 25 ms



Upstream	NW10DC -C N/H					NW10DC -C N/H					NW10DC -C N/H				
						NW20DC -C N/H					NW20DC -C N/H				
											NW40DC-C N/H				
	2P2D														
	Trip unit														
Micrologic 1.0 DC															
Range 1250/2500A					Range 2500/5400A					Range 5000/11000A					
Type	A	B	C	D	E	A	B	C	D	E	A	B	C	D	E
Setting	1250	1500	1600	2000	2500	2500	3300	4000	5000	5400	5000	8000	10000	11000	11000

Downstream	Rating	Im	Selectivity limit (kA) <sup>[2]</sup>													
iC60 N / H	0.5-63		T	T	T	T	T	T	T	T	T	T	T	T	T	T
C60H-DC	0.5-63		T	T	T	T	T	T	T	T	T	T	T	T	T	T
C120 N/H	63		T	T	T	T	T	T	T	T	T	T	T	T	T	T
	80	1.25	T	T	T	T	T	T	T	T	T	T	T	T	T	T
	100	1.25	1.5	T	T	T	T	T	T	T	T	T	T	T	T	T
	125	1.25	1.5	1.6	T	T	T	T	T	T	T	T	T	T	T	T
NG125 N/H/L B-C-D Curves	10-50		T	T	T	T	T	T	T	T	T	T	T	T	T	T
	63		T	T	T	T	T	T	T	T	T	T	T	T	T	T
	80	1.25	T	T	T	T	T	T	T	T	T	T	T	T	T	T
	100 (N)	1.25	1.5	T	T	T	T	T	T	T	T	T	T	T	T	T
	125 (N)	1.25	1.5	1.6	T	T	T	T	T	T	T	T	T	T	T	T
NSX100DC N/H TM-D	16	260	1.25	1.5	1.6	10	T	T	T	T	T	T	T	T	T	T
	25	400	1.25	1.5	1.6	5	10	10	T	T	T	T	T	T	T	T
	32	400	1.25	1.5	1.6	2	5	5	T	T	T	T	T	T	T	T
	40	700		1.5	1.6	2	2.5	2.5	10	T	T	T	T	T	T	T
	50	700		1.5	1.6	2	2.5	2.5	5	T	T	T	T	T	T	T
	63	700		1.5	1.6	2	2.5	2.5	3.3	T	T	T	T	T	T	T
TM-DC	80	800		1.5	1.6	2	2.5	2.5	3.3	4	T	T	T	T	T	T
	100	1000				2	2.5	2.5	3.3	4	5	T	T	T	T	T
	NSX100DC TM-G	16	80	1.25	1.5	1.6	10	T	T	T	T	T	T	T	T	T
	25	100	1.25	1.5	1.6	5	10	10	T	T	T	T	T	T	T	T
	40	100		1.5	1.6	2	2.5	2.5	10	T	T	T	T	T	T	T
	63	150		1.5	1.6	2	2.5	2.5	3.3	T	T	T	T	T	T	T
	80	250		1.5	1.6	2	2.5	2.5	3.3	4	T	T	T	T	T	T
	100	400				2	2.5	2.5	3.3	4	5	T	T	T	T	T
NSX160DC TM-DC	100	1000				2	2.5	2.5	5	T	T	T	T	T	T	T
	125	1200					2.5	2.5	3.3	10	T	T	T	T	T	T
	160	1250					2.5	2.5	3.3	5	10	T	T	T	T	T
NSX160DC TM-G	125	530	1.25	1.5	1.6	2	2.5	2.5	3.3	10	T	T	T	T	T	T
	160	530	1.25	1.5	1.6	2	2.5	2.5	3.3	5	10	T	T	T	T	T
NSX250DC TM-DC	200	1000				2	2.5	2.5	5	T	T	T	T	T	T	T
		2000								5	T	T	T	T	T	T
	250	1250					2.5	2.5	3.3	5	10	T	T	T	T	T
		2500								2.5	3.3	4	5	T	T	T
NSX250DC TM-G	200	530	1.25	1.5	1.6	2	2.5	2.5	5	T	T	T	T	T	T	T
	250	625		1.5	1.6	2	2.5	2.5	3.3	5	10	T	T	T	T	T

[1] Type of circuit breaker (1P1D, 2P2D) depend on earthing system and circuit breaker ranges.  
 For voltage up to 60Vdc one single pole of iC60 C120 NG125 NSX range is enough to break the current.  
 For ranges with 3P or 4P breakers only (NSX250 for example), one or two poles only are used of a 3P circuit breaker.

[2] According to the voltage and nb of pole used, the breaking capacity can be changed.  
 Selectivity limit is the minimum of the value indicated in the table and the breaking capacity of downstream circuit breaker.

[3] This table is applicable for Case 1, Case 2, Case 3, Case 4 defined in introduction with this voltage between + and -.  
 Selectivity limits in this table for case 1 and Case 3 can also apply to system with higher voltage (up to 2 times) for the same circuit breaker (same number of poles used).

Compliance of circuit breakers according to voltage and earthing system shall be checked before using this table.

# Selectivity table

Upstream: Masterpact NW DC

Downstream: Compact NSX400/630/1200 DC, Masterpact NW DC



Ue: 24-48-60 V DC <sup>[3]</sup>

Time constant: 1.5 ms - 25 ms

Upstream	NW10DC -C N/H					NW10DC -C N/H					NW10DC -C N/H				
						NW20DC -C N/H					NW20DC -C N/H				
											NW40DC-C N/H				
	2P2D														
	Trip unit														
Micrologic 1.0 DC															
Range 1250/2500A					Range 2500/5400A					Range 5000/11000A					
A	B	C	D	E	A	B	C	D	E	A	B	C	D	E	
Setting	1250	1500	1600	2000	2500	2500	3300	4000	5000	5400	5000	8000	10000	11000	11000

Downstream	Rating	Im	Selectivity limit (kA) <sup>[2]</sup>															
NSX400DC	250	635	1.25	1.5	1.6	2	2.5	2.5	3.3	4	5	5.4	5	T	T	T	T	
	TM-DC	1250					2.5	2.5	3.3	4	5	5.4	5	T	T	T	T	
	3P3D <sup>[1]</sup>	320	800			1.6	2	2.5	2.5	3.3	4	5	5.4	5	T	T	T	T
		400	1000				2	2.5	2.5	3.3	4	5	5.4	5	10	T	T	T
NSX630DC	500	1250						2.5	3.3	4	5	5.4	5	T	T	T	T	
	TM-DC	2500									5	5.4	5	10	T	T	T	
	3P3D <sup>[1]</sup>	600	1500							3.3	4	5	5.4	5	10	T	T	T
			3000												10	T	T	T
NSX1200DC	630	1575							3.3	4	5	5.4	5	8	10	11	11	
	TM-DC	3150												8	10	11	11	
	3P3D <sup>[1]</sup>	800	2000								4	5	5.4	5	8	10	11	11
			4000												8	10	11	11
		1000	2500											5	8	10	11	11
			5000													10	11	11
	1200	3000												8	10	11	11	
	6000														11	11	11	
NW DC-C	1000	1250							3.3	4	5	5.4	5	8	10	11	11	
		2500									5	5.4	5	8	10	11	11	
	1000/2000	2500									5	5.4	5	8	10	11	11	
		5400													10	11	11	
	1000/2000/4000	5000													10	11	11	
	11000																	

[1] Type of circuit breaker (1P1D, 2P2D) depend on earthing system and circuit breaker ranges.

For voltage up to 60Vdc one single pole of iC60 C120 NG125 NSX range is enough to break the current.

For ranges with 3P or 4P breakers only (NSX250 for example), one or two poles only are used of a 3P circuit breaker.

[2] According to the voltage and nb of pole used, the breaking capacity can be changed.

Selectivity limit is the minimum of the value indicated in the table and the breaking capacity of downstream circuit breaker.

[3] This table is applicable for Case 1, Case 2, Case 3, Case 4 defined in introduction with this voltage between + and -.

Selectivity limits in this table for case 1 and Case 3 can also apply to system with higher voltage (up to 2 times) for the same circuit breaker (same number of poles used).

Compliance of circuit breakers according to voltage and earthing system shall be checked before using this table.

# Selectivity table

Upstream: C60H-DC curve C

Downstream: C60H-DC curve C

Ue: 110, 125 V DC [3]

Time constant: 1.5 ms - 25 ms



Upstream	C60H-DC, 1P or 2P [1]												
	Curve C												
In (A)	1	2	3	4	6	10	16	20	25	32	40	50	63

Downstream															
Circuit breaker	Curve	Rating (A)	Selectivity limit (A) [2]												
C60H-DC 1P or 2P [1]	C	0.5	T	T	T	T	T	T	T	T	T	T	T	T	T
		1					250	T	T	T	T	T	T	T	T
		2						250	900	1800	11000	T	T	T	T
		3							300	500	700	1800	5000	T	T
		4										900	1300	3000	6000
		6												1200	1800
		≥ 10													

T : Total selectivity.

500 : Selectivity limit = 500 A

: No selectivity.

[1] Type of circuit breaker (1P1D, 2P2D) depend on earthing system and circuit breaker ranges.

For voltage up to 60Vdc one single pole of iC60 C120 NG125 NSX range is enough to break the current.

For ranges with 3P or 4P breakers only (NSX250 for example), one or two poles only are used of a 3P circuit breaker.

[2] According to the voltage and nb of pole used, the breaking capacity can be changed.

Selectivity limit is the minimum of the value indicated in the table and the breaking capacity of downstream circuit breaker.

[3] This table is applicable for Case 1, Case 2, Case 3, Case 4 defined in introduction with this voltage between + and -.

Selectivity limits in this table for case 1 and Case 3 can also apply to system with higher voltage (up to 2 times) for the same circuit breaker (same number of poles used).

Compliance of circuit breakers according to voltage and earthing system shall be checked before using this table.

# Selectivity table

Upstream: C120, NG125 curves B, C, D

Downstream: C60H-DC curve C



U<sub>e</sub>: 110, 125 V DC <sup>[3]</sup>

Time constant: 1.5 ms - 25 ms

Upstream		C120N/H/L, NG125N/H/L, 1P or 2P <sup>[1]</sup>										
		Curve B										
In (A)		10	16	20	25	32	40	50	63	80	100	125

Downstream													
Circuit breaker	Curve	Rating (A)	Selectivity limit (A) <sup>[2]</sup>										
C60H-DC 1P or 2P <sup>[1]</sup>	C	0.5	500	T	T	T	T	T	T	T	T	T	T
		1		450	T	T	T	T	T	T	T	T	T
		2			500	800	2500	T	T	T	T	T	T
		3						2400	4000	5000	T	T	T
		4						800	1000	1500	5000	3000	7000
		6									1800	1500	2500
		10											
		16											
		≥ 20											

Upstream		C120N/H/L, NG125N/H/L, 1P or 2P <sup>[1]</sup>										
		Curve C										
In (A)		10	16	20	25	32	40	50	63	80	100	125

Downstream													
Circuit breaker	Curve	Rating (A)	Selectivity limit (A) <sup>[2]</sup>										
C60H-DC 1P or 2P <sup>[1]</sup>	C	0.5	T	T	T	T	T	T	T	T	T	T	T
		1	1000	T	T	T	T	T	T	T	T	T	T
		2		5000	T	T	T	T	T	T	T	T	T
		3			1800	T	T	T	T	T	T	T	T
		4				1300	5500	12000	T	T	T	T	T
		6					2400	3000	6000	7000	12000	T	T
		10								3500	5500	8500	T
		16										5500	9000
		20											6000
		≥ 32											5000

Upstream		C120N/H/L, NG125N/H/L, 1P or 2P <sup>[1]</sup>										
		Curve D										
In (A)		10	16	20	25	32	40	50	63	80	100	125

Downstream													
Circuit breaker	Curve	Rating (A)	Selectivity limit (A) <sup>[2]</sup>										
C60H-DC 1P or 2P <sup>[1]</sup>	C	≤ 1	T	T	T	T	T	T	T	T	T	T	T
		2	2500	6000	T	T	T	T	T	T	T	T	T
		3	700	1500	7000	T	T	T	T	T	T	T	T
		4			1800	10000	12000	T	T	T	T	T	T
		6				2500	3000	4000	6000	7000	T	T	T
		10									2000	3000	T
		16										9000	T
		20									5000	T	T
		25											T
		32										10000	T
		≥ 50										5000	12000

- T : Total selectivity.
- 500 : Selectivity limit = 500 A
- : No selectivity.

<sup>[1]</sup> Type of circuit breaker depend on earthing system and circuit breaker ranges (see Distribution guide direct current CA908061).

<sup>[2]</sup> According to the voltage and number of pole used, the breaking capacity can be changed. Selectivity limit is the minimum of the value indicated in the table and the breaking capacity of downstream circuit breaker.

<sup>[3]</sup> This table is applicable for Case 1, Case 2, Case 3, Case 4 defined in introduction with this voltage between + and - Selectivity limits in this table for Case 3 and Case 4 can also apply to system with higher voltage (up to 2 times) for the same circuit breaker (same number of poles used).

Compliance of circuit breakers according to voltage and earthing system shall be checked before using this table.

# Selectivity table

Upstream: Compact NSX100/160/250 DC TM-DC

Downstream: iC60, C60H-DC, C120, NG125

Ue: 110, 125 V DC <sup>[3]</sup>

Time constant: 1.5 ms - 25 ms



Upstream	NSX100DC								NSX160DC			NSX250 DC				
	1P1D 2P2D F/N/M/S 3P3D F/S <sup>[1]</sup>											3P3D (1 or 2 P used) F/S <sup>[1]</sup>				
	Trip unit	TMD, TM-DC								TMD, TM-DC			TM-DC			
	Rating	16	25	32	40	50	63	80	100	100	125	160	160	200	250	
Im	fixed	fixed	fixed	fixed	fixed	fixed	fixed	fixed	fixed	fixed	fixed	fixed	Mini	Maxi	Mini	Maxi
	260	400	550	700	700	800	800	800	800	1250	1250	1250	1000	2000	1250	2500

Downstream	Rating	Selectivity limit (kA) <sup>[2]</sup>															
iC60 N/H/L B-C-D Curves	0.5	T	T	T	T	T	T	T	T	T	T	T	T	T	T	T	
	1	T	T	T	T	T	T	T	T	T	T	T	T	T	T	T	
	2	10	T	T	T	T	T	T	T	T	T	T	T	T	T	T	
	3	5	10	T	T	T	T	T	T	T	T	T	T	T	T	T	
	4	0.26	5	T	T	T	T	T	T	T	T	T	T	T	T	T	
	5		0.4	10	10	T	T	T	T	T	T	T	T	T	T	T	
	6			5	5	10	T	T	T	T	T	T	T	T	T	T	
	10			0.55	0.7	5	T	T	T	T	T	T	T	T	T	T	
	13					0.7	T	T	T	T	T	T	T	T	T	T	
	15-16						5	T	T	T	T	T	T	T	T	T	
	20						0.7	10	10	10	T	T	T	T	T	T	
	25							5	10	10	T	T	T	T	T	T	
	32							0.8	10	10	T	T	T	10	T	T	
	40								5	5	10	T	T	5	T	T	
50								0.8	0.8	10	10	10		T	10		
63										5	10	5		T	5		
C60H-DC C Curves	0.5	5	T	T	T	T	T	T	T	T	T	T	T	T	T	T	
	1	5	10	T	T	T	T	T	T	T	T	T	T	T	T	T	
	2	0.26	5	10	T	T	T	T	T	T	T	T	T	T	T	T	
	3		0.4	5	10	T	T	T	T	T	T	T	T	T	T	T	
	4			0.5	5	10	T	T	T	T	T	T	T	T	T	T	
	5				0.7	5	T	T	T	T	T	T	T	T	T	T	
	6					5	10	T	T	T	T	T	T	T	T	T	
	10					0.7	5	10	T	T	T	T	T	T	T	T	
	13						0.7	5	10	10	T	T	T	T	T	T	
	15-16							0.8	10	10	T	T	T	10	T	T	
	20								5	5	T	T	T	5	T	T	
	25								0.8	0.8	10	T	T	0.8	T	T	
	30-32										5	10	10		T	10	
	40											5	5		T	5	
50														10	10		
63														5	5		
C120 N/H B-C-D Curves	63										1.25	1.25		5	10	T	
	80													2		T	
	100													2		T	
	125															T	
NG125 N/H/L B-C-D Curves	10		0.4	0.5	0.7	0.7	0.7	0.8	0.8	0.8	10	10	10	5	T	T	T
	16			0.5	0.7	0.7	0.7	0.8	0.8	0.8	10	10	10	1	T	T	T
	20				0.7	0.7	0.7	0.8	0.8	0.8	10	10	10	1	T	T	T
	25						0.7	0.8	0.8	0.8	5	10	10	1	T	T	T
	32							0.8	0.8	0.8	1.25	5	5	1	T	T	T
	40								0.8	0.8	1.25	1.25	1.25	1	10	T	T
	50										1.25	1.25	1.25	1	5	T	T
	63											1.25	1.25		5	10	T
	80														2		T
	100 (N)														2		T
	125 (N)																T

[1] Type of circuit breaker (1P1D, 2P2D) depend on earthing system and circuit breaker ranges.

For voltage up to 60Vdc one single pole of iC60 C120 NG125 NSX range is enough to break the current.

For ranges with 3P or 4P breakers only (NSX250 for example), one or two poles only are used of a 3P circuit breaker.

[2] According to the voltage and nb of pole used, the breaking capacity can be changed.

Selectivity limit is the minimum of the value indicated in the table and the breaking capacity of downstream circuit breaker.

[3] This table is applicable for Case 1, Case 2, Case 3, Case 4 defined in introduction with this voltage between + and -.

Selectivity limits in this table for case 1 and Case 3 can also apply to system with higher voltage (up to 2 times) for the same circuit breaker (same number of poles used).

Compliance of circuit breakers according to voltage and earthing system shall be checked before using this table.

# Selectivity table

Upstream: Compact NSX100/160/250 DC with parallel connection of poles

Downstream: iC60, C60H-DC, C120, NG125

Ue: 110, 125 V DC <sup>[3]</sup>

Time constant: 1.5 ms - 25 ms

A

Upstream	NSX 100DC F				NSX 160DC F		NSX 250 DC F			NSX 100DC F				NSX 160DC F		NSX 250 DC F	
	2P2D						3P3D 2P used			4P4D							
	Parallel connection for + or -						Parallel connection for + or -			2 poles with parallel connection for + and - [2]							
	Trip unit	TM-D, TM-DC						TM-DC			TM-D, TM-DC				TM-DC		
Rating	50	63	80	125	160	200	160	200	50	63	80	125	160	200			
Equivalent rated current	125	158	200	313	400	500			115	145	184	288	368	460			
Im	fixed	fixed	fixed	fixed	fixed	Mini	Maxi	fixed	fixed	fixed	fixed	fixed	Mini	Maxi			
	1400	1400	1600	2500	2500	2000	4000	1400	1400	1600	2500	2500	2000	4000			

Downstream	Rating	Selectivity limit (kA) <sup>[2]</sup>														
iC60 N/H/L B-C-D Curves	0.5	T	T	T	T	T	T	T	T	T	T	T	T	T	T	
	1	T	T	T	T	T	T	T	T	T	T	T	T	T	T	
	2	T	T	T	T	T	T	T	T	T	T	T	T	T	T	
	3	T	T	T	T	T	T	T	T	T	T	T	T	T	T	
	4	T	T	T	T	T	T	T	T	T	T	T	T	T	T	
	5	T	T	T	T	T	T	T	T	T	T	T	T	T	T	
	6	T	T	T	T	T	T	T	T	T	T	T	T	T	T	
	10	T	T	T	T	T	T	T	T	T	T	T	T	T	T	
	2x (1P1D or 2P2D) <sup>[1]</sup> (2 Poles in serie)	13	T	T	T	T	T	T	T	T	T	T	T	T	T	T
		15-16	T	T	T	T	T	T	T	v	T	T	T	T	T	T
		20	10	T	T	T	T	T	T	10	T	T	T	T	T	T
		25	5	T	T	T	T	T	T	5	T	T	T	T	T	T
		32	0.8	T	T	T	T	T	T	0.8	T	T	T	T	T	T
		40		10	T	T	T	T	T		10	T	T	T	T	T
50			10	10	T	T	10	T		10	10	T	T	10	T	
63			5	10	T	T	5	T		5	10	T	T	5	T	
C60H-DC C Curves	0.5	T	T	T	T	T	T	T	T	T	T	T	T	T	T	
	1	T	T	T	T	T	T	T	T	T	T	T	T	T	T	
	2	T	T	T	T	T	T	T	T	T	T	T	T	T	T	
	3	T	T	T	T	T	T	T	T	T	T	T	T	T	T	
	4	T	T	T	T	T	T	T	T	T	T	T	T	T	T	
	5	T	T	T	T	T	T	T	T	T	T	T	T	T	T	
	6	T	T	T	T	T	T	T	T	T	T	T	T	T	T	
	10	10	T	T	T	T	T	T	10	T	T	T	T	T	T	
	13	5	T	T	T	T	T	T	5	T	T	T	T	T	T	
	15-16	0.8	T	T	T	T	T	T	0.8	T	T	T	T	T	T	
	20		T	T	T	T	T	T		T	T	T	T	T	T	
	25		10	T	T	T	T	T		10	T	T	T	T	T	
	30-32		5	10	T	T	10	T		5	10	T	T	10	T	
	40			5	T	T	5	T			5	T	T	5	T	
50				10	T		T				10	T		T		
63				5	T		T				5	T		T		
C120 N/H B-C-D Curves	63			1.25	T	T	10	T			1.25	T	T	10	T	
	80				T	T		T				T	T		T	
	100				T	T		T				T	T		T	
	125				T	T		T				T	T		T	
NG125 N/H/L B-C-D Curves	10	0.8	10	10	T	T	T	0.8	10	10	T	T	T	T	T	
	16	0.8	10	10	T	T	T	0.8	10	10	T	T	T	T	T	
	20	0.8	10	10	T	T	T	0.8	10	10	T	T	T	T	T	
	25	0.8	5	10	T	T	T	0.8	5	10	T	T	T	T	T	
	32	0.8	1.25	5	T	T	T	0.8	1.25	5	T	T	T	T	T	
	40		1.25	1.25	T	T	T		1.25	1.25	T	T	T	T	T	
	50		1.25	1.25	T	T	T		1.25	1.25	T	T	T	T	T	
	63			1.25	T	T	10	T		1.25	T	T	10	T	T	
	80				T	T		T			T	T		T	T	
	100 (N)				T	T		T			T	T		T	T	
	125 (N)				T	T		T			T	T		T	T	

[1] Type of circuit breaker (1P1D, 2P2D) depend on earthing system and circuit breaker ranges.  
 For voltage up to 60Vdc one single pole of iC60 C120 NG125 NSX range is enough to break the current.  
 For ranges with 3P or 4P breakers only (NSX250 for example), one or two poles only are used of a 3P circuit breaker.

[2] According to the voltage and nb of pole used, the breaking capacity can changed.  
 Selectivity limit is the minimum of the value indicated in the table and the breaking capacity of downstream circuit breaker.

[3] This table is applicable for Case 1, Case 2, Case 3, Case 4 defined in introduction with this voltage between + and -.  
 Selectivity limits in this table for case 1 and Case 3 can also apply to system with higher voltage (up to 2 times) for the same circuit breaker (same number of poles used).

Compliance of circuit breakers according to voltage and earthing system shall be checked before using this table.



# Selectivity table

Upstream: Compact NSX100/160/250DC TM-G

Downstream: iC60, C60H-DC, NG125

Ue: 110, 125 V DC <sup>[3]</sup>

Time constant: 1.5 ms - 25 ms



Upstream	NSX100DC						NSX160DC			NSX250 DC			
	3P3D (1 or 2 P used) F/S <sup>[1]</sup>												
	Trip unit	TM-G						TM-G			TM-G		
	Rating	16	25	40	63	80	100	100	125	160	160	200	250
Im	80	100	100	150	250	400	400	530	530	530	530	625	

Downstream	In	Selectivity limit (kA) <sup>[2]</sup>												
<b>iC60 N/H/L</b> B-C-D Curves	0.5	10	10	10	T	T	T	T	T	T	T	T	T	
	1	5	5	5	T	T	T	T	T	T	T	T	T	
	2	0.08	0.1	0.1	10	T	T	T	T	T	T	T	T	
	3			0.1	5	10	T	T	T	T	T	T	T	
	4				0.15	5	10	10	T	T	T	T	T	
	<b>2x(1P1D or 2P2D)</b> <sup>[1]</sup>	5					0.25	5	5	T	T	T	T	T
		6						0.4	0.4	T	T	T	T	T
	<b>(2 Poles in serie)</b>	10								10	10	10	10	T
		13								5	5	5	5	10
		15-16								5	5	5	5	5
20									5	5	5	5	5	
25									0.5	0.5	0.5	0.5	5	
32													0.6	
40														
50														
63														
<b>C60H-DC</b> C Curves	0.5	5	5	5	10	T	T	T	T	T	T	T	T	
	1	0.08	0.1	0.1	5	10	T	T	T	T	T	T	T	
	2		0.1	0.1	0.15	5	10	10	T	T	T	T	T	
	3			0.1	0.15	0.25	5	5	T	T	T	T	T	
	4				0.15	0.25	0.4	0.4	T	T	T	T	T	
	5					0.25	0.4	0.4	T	T	T	T	T	
	6						0.4	0.4	10	10	10	10	T	
	10								10	10	10	10	10	
	13								5	5	5	5	10	
	15-16								0.5	0.5	0.5	0.5	5	
20								0.5	0.5	0.5	0.5	0.6		
25									0.5	0.5	0.5	0.6		
30-32												0.6		
40														
50														
63														
<b>NG125 N/H/L</b> B-C-D Curves	10					0.25	0.4	0.4	0.5	0.5	0.5	0.5	0.6	
	16						0.4	0.5	0.5	0.5	0.5	0.5	0.6	
	20								0.5	0.5	0.5	0.5	0.6	
	25												0.6	
	32													
40														

[1] Type of circuit breaker (1P1D, 2P2D) depend on earthing system and circuit breaker ranges.

For voltage up to 60Vdc one single pole of iC60 C120 NG125 NSX range is enough to break the current.

For ranges with 3P or 4P breakers only (NSX250 for example), one or two poles only are used of a 3P circuit breaker.

[2] According to the voltage and nb of pole used, the breaking capacity can be changed.

Selectivity limit is the minimum of the value indicated in the table and the breaking capacity of downstream circuit breaker.

[3] This table is applicable for Case 1, Case 2, Case 3, Case 4 defined in introduction with this voltage between + and -.

Selectivity limits in this table for case 1 and Case 3 can also apply to system with higher voltage (up to 2 times) for the same circuit breaker (same number of poles used).

Compliance of circuit breakers according to voltage and earthing system shall be checked before using this table.

# Selectivity table

Upstream: Compact NSX100/160/250 DC TM-D, TM-DC

Downstream: Compact NSX100/160 DC TM-D, TM-DC, TM-G



Ue: 110, 125 V DC <sup>[3]</sup>

Time constant: 1.5 ms - 25 ms

Upstream	NSX100 DC								NSX160 DC				NSX250 DC				
	1P1D 2P2D F/N/M/S (3P3D F/S) <sup>[1]</sup>												3P3D (1 or 2 P Used) F/S <sup>[1]</sup>				
	Trip unit	TM-D							TM-D, TM-DC				TM-DC				
	Rating	16	25	32	40	50	63	80	100	80	100	125	160	160	200	250	
	fixed	fixed	fixed	fixed	fixed	fixed	fixed	fixed	fixed	fixed	fixed	fixed	fixed	Mini	Maxi	Mini	Maxi
Im	260	400	550	700	700	700	640	800	640	800	1250	1250	1250	1000	2000	1250	2500

Downstream Rating	Im	Selectivity limit (kA) <sup>[2]</sup>																			
<b>NSX100DC</b>	16	260			0.5	0.7	0.7	0.7	0.7	0.8	0.7	0.8	1.25	1.25	1.25	1	2	1.25	5		
	<b>TM-D</b>	25	400				0.7	0.7	0.7	0.7	0.8	0.7	0.8	1.25	1.25	1.25	1	2	1.25	5	
	<b>(TM-DC)</b>	32	400						0.7	0.7	0.8	0.7	0.8	1.25	1.25	1.25	1	2	1.25	5	
	<b>1P1D or 2P2PD (3P3D) <sup>[1]</sup></b>	40	700							0.7	0.8	0.7	0.8	1.25	1.25	1.25	1	2	1.25	2.5	
		50	700								0.7	0.8	0.7	0.8	1.25	1.25	1.25	1	2	1.25	2.5
		63	700									0.8	0.8	1.25	1.25	1.25	1	2	1.25	2.5	
	80	800											1.25	1.25	1.25	1	2	1.25	2.5		
	100	1000											1.25	1.25	1.25	1	2	1.25	2.5		
<b>NSX100DC</b>	16	80			0.5	0.7	0.7	0.7	0.7	0.8	0.7	0.8	1.25	1.25	1.25	1	2	1.25	10		
	<b>TM-G</b>	25	100				0.7	0.7	0.7	0.7	0.8	0.7	0.8	1.25	1.25	1.25	1	2	1.25	5	
	<b>3P3D <sup>[1]</sup></b>	40	100							0.7	0.8	0.7	0.8	1.25	1.25	1.25	1	2	1.25	5	
		63	150								0.7	0.8		0.8	1.25	1.25	1.25	1	2	1.25	5
		80	250									0.8			1.25	1.25	1.25	1	2	1.25	2.5
		100	400												1.25	1.25	1.25	1	2	1.25	2.5
<b>NSX160DC</b>	100	1000											1.25	1.25	1.25	1	2	1.25	2.5		
<b>1P1D or 2P2D</b>	125	1200																	1.25	2.5	
<b>3P2D <sup>[1]</sup></b>	160	1250																			
<b>NSX160DC</b>	125	530																	1.25	2.5	
<b>TM-G 3P3D <sup>[1]</sup></b>	160	530																			

[1] Type of circuit breaker (1P1D, 2P2D) depend on earthing system and circuit breaker ranges.

For voltage up to 60Vdc one single pole of iC60 C120 NG125 NSX range is enough to break the current.

For ranges with 3P or 4P breakers only (NSX250 for example), one or two poles only are used of a 3P circuit breaker.

[2] According to the voltage and nb of pole used, the breaking capacity can be changed.

Selectivity limit is the minimum of the value indicated in the table and the breaking capacity of downstream circuit breaker.

[3] This table is applicable for Case 1, Case 2, Case 3, Case 4 defined in introduction with this voltage between + and -.

Selectivity limits in this table for Case 1 and Case 3 can also apply to system with higher voltage (up to 2 times) for the same circuit breaker (same number of poles used).

Compliance of circuit breakers according to voltage and earthing system shall be checked before using this table.

# Selectivity table

Upstream: Compact NSX400/630/1200 DC TM-DC

Downstream: iC60, C60H-DC, C120, NG125

Ue: 110, 125 V DC <sup>[3]</sup>

Time constant: 1.5 ms - 25 ms



Upstream	NSX400DC F/S						NSX630DC F/S				NSX1200DC N								
	3P3D (1 or 2 P Used) <sup>[1]</sup>												2P2D						
	TM-DC						TM-DC				TM-DC								
	250		320		400		500		600		630		800		1000		1200		
Rating		min	max	min	max	min	max	min	max	min	max	min	max	min	max	min	max		
Im		625	1250	800	1600	1000	2000	1250	2500	1500	3000	1575	3150	2000	4000	2500	5000	3000	6000

Downstream	Rating	Selectivity limit (kA) <sup>[2]</sup>																	
iC60 N/H/L B-C-D Curves	0.5	T	T	T	T	T	T	T	T	T	T	T	T	T	T	T	T	T	T
	1	T	T	T	T	T	T	T	T	T	T	T	T	T	T	T	T	T	T
	2	T	T	T	T	T	T	T	T	T	T	T	T	T	T	T	T	T	T
	3	T	T	T	T	T	T	T	T	T	T	T	T	T	T	T	T	T	T
	4	T	T	T	T	T	T	T	T	T	T	T	T	T	T	T	T	T	T
	2x (1P1D or 2P2D) <sup>[1]</sup> (2 Poles in serie)	5	T	T	T	T	T	T	T	T	T	T	T	T	T	T	T	T	T
		6	T	T	T	T	T	T	T	T	T	T	T	T	T	T	T	T	T
		10	10	T	10	T	T	T	T	T	T	T	T	T	T	T	T	T	T
		13	5	T	10	T	T	T	T	T	T	T	T	T	T	T	T	T	T
		15-16	0.6	T	5	T	10	T	T	T	T	T	T	T	T	T	T	T	T
		20		10	5	T	5	T	T	T	T	T	T	T	T	T	T	T	T
		25		5	0.8	10	5	T	T	T	T	T	T	T	T	T	T	T	T
		32		1.25	0.8	10	1	10	T	T	T	T	T	T	T	T	T	T	T
40				10		10	T	T	T	T	T	T	T	T	T	T	T		
50				5		5	T	T	T	T	T	T	T	T	T	T	T		
63				5		2	T	T	T	T	T	T	T	T	T	T	T		
C60H-DC C curve 1P1D or 2P2D <sup>[1]</sup>	0.5	T	T	T	T	T	T	T	T	T	T	T	T	T	T	T	T	T	
	1	T	T	T	T	T	T	T	T	T	T	T	T	T	T	T	T	T	
	2	T	T	T	T	T	T	T	T	T	T	T	T	T	T	T	T	T	
	3	T	T	T	T	T	T	T	T	T	T	T	T	T	T	T	T	T	
	4	15	T	T	T	T	T	T	T	T	T	T	T	T	T	T	T	T	
	5	10	T	T	T	T	T	T	T	T	T	T	T	T	T	T	T	T	
	6	5	T	15	T	15	T	T	T	T	T	T	T	T	T	T	T	T	
	10	0.6	T	10	T	10	T	T	T	T	T	T	T	T	T	T	T	T	
	13		15	5	T	5	T	T	T	T	T	T	T	T	T	T	T	T	
	15-16		5	0.8	15	5	15	T	T	T	T	T	T	T	T	T	T	T	
	20		1.25		10	5	10	T	T	T	T	T	T	T	T	T	T	T	
	25				10	1	10	T	T	T	T	T	T	T	T	T	T	T	
	30-32				5	1	10	T	T	T	T	T	T	T	T	T	T	T	
40				5	1	5	T	T	T	T	T	T	T	T	T	T	T		
50				5	1	5	10	T	T	T	T	T	T	T	T	T	T		
63				5	1	5	10	T	T	T	T	T	T	T	T	T	T		
C120 N/H B-C-D Curves 1P1D or 2P2D <sup>[1]</sup>	63							T		T		T		T	2.5	T	T	T	
	80							5		T		T		T		T	T	T	
	100 (N)							5		10		10		10		T	T	T	
	125 (N)							5		5		5		5		T	T	T	
NG125 N/H/L B-C-D Curves 1P1D or 2P2D <sup>[1]</sup>	10	0.625	1.25	0.8	1.6	1	5	T	10	T	10	T	T	T	T	T	T	T	
	16				1.6	1	2	5	T	5	T	5	T	T	T	T	T	T	
	20						2	1.25	T	1.5	T	1.5	T	T	T	T	T	T	
	25								T	T		T	10	T	T	T	T	T	
	32								T	T		T	5	T	10	T	T	T	
	40								T	T		T	2	T	5	T	T	T	
	50								T	T		T	2	T	2.5	T	T	T	
	63								T	T		T		T	2.5	T	T	T	
	80								5	T		T		T		T	T	T	
	100 (N)								5		10		10		10		T	T	T
	125 (N)								5		5		5		5		T	T	T

**[1]** Type of circuit breaker (1P1D, 2P2D) depend on earthing system and circuit breaker ranges.  
 For voltage up to 60Vdc one single pole of iC60 C120 NG125 NSX range is enough to break the current.  
 For ranges with 3P or 4P breakers only (NSX250 for example), one or two poles only are used of a 3P circuit breaker.

**[2]** According to the voltage and nb of pole used, the breaking capacity can be changed.  
 Selectivity limit is the minimum of the value indicated in the table and the breaking capacity of downstream circuit breaker.

**[3]** This table is applicable for Case 1, Case 2, Case 3, Case 4 defined in introduction with this voltage between + and -.  
 Selectivity limits in this table for case 1 and Case 3 can also apply to system with higher voltage (up to 2 times) for the same circuit breaker (same number of poles used).

Compliance of circuit breakers according to voltage and earthing system shall be checked before using this table.

# Selectivity table

Upstream: Compact NSX400/630/1200 DC TM-DC

Downstream: Compact NSX100/160/250 DC, TM-D, TM-DC, TM-G



U<sub>e</sub>: 110, 125 V DC <sup>[3]</sup>

Time constant: 1.5 ms - 25 ms

Upstream	Trip unit	NSX400DC F/S						NSX630DC F/S				NSX1200DC N							
		TM-DC						TM-DC				TM-DC							
		250		320		400		500		600		630		800		1000		1200	
		min	max	min	max	min	max	min	max	min	max	min	max	min	max	min	max	min	max
	Im	625	1250	800	1600	1000	2000	1250	2500	1500	3000	1575	3150	2000	4000	2500	5000	3000	6000

Downstream Rating			Selectivity limit (kA) <sup>[2]</sup>																			
NSX100DC	16	260	0.63	1.25	0.8	1.6	1	2	1.25	2.5	1.5	3	1.5	3.1	2	4	2.5	5	3	T		
	TM-D (TM-DC)	25	400	0.63	1.25	0.8	1.6	1	2	1.25	2.5	1.5	3	1.5	3.1	2	4	2.5	5	3	10	
		32	400		1.25	0.8	1.6	1	2	1.25	2.5	1.5	3	1.5	3.1	2	4	2.5	5	3	6	
		1P1D or 2P2PD		40	700		0.8	1.6	1	2	1.25	2.5	1.5	3	1.5	3.1	2	4	2.5	5	3	6
		(3P3D)		50	700			1.6	1	2	1.25	2.5	1.5	3	1.5	3.1	2	4	2.5	5	3	6
<sup>[1]</sup>	63		700				1	2	1.25	2.5	1.5	3	1.5	3.1	2	4	2.5	5	3	6		
	80		800					2		2.5		3	1.5	3.1	2	4	2.5	5	3	6		
	100		1000					2		2.5		3		3.1	2	4	2.5	5	3	6		
	16		80	0.63	1.25	0.8	1.6	1	2	1.25	2.5	1.5	3	1.5	3.1	2	4	2.5	5	3	T	
NSX100DC	25	100	0.63	1.25	0.8	1.6	1	2	1.25	2.5	1.5	3	1.5	3.1	2	4	2.5	5	3	10		
	TM-G	40	100		0.8	1.6	1	2	1.25	2.5	1.5	3	1.5	3.1	2	4	2.5	5	3	6		
		3P3P		40	100			1	2	1.25	2.5	1.5	3	1.5	3.1	2	4	2.5	5	3	6	
		<sup>[1]</sup>		63	150				1	2	1.25	2.5	1.5	3	1.5	3.1	2	4	2.5	5	3	6
		80		250					2		2.5		3	1.5	3.1	2	4	2.5	5	3	6	
100		400					2		2.5		3	1.5	3.1	2	4	2.5	5	3	6			
NSX160DC	100	1000						2		2.5		3	1.5	3.1	2	4	2.5	5	3	6		
	TM-DC	125	1200							2.5		3		3.1		4	2.5	4	3	6		
		1P1D or 2P2PD		160	1250						2.5		3		3.1		4	2.5	4	3	6	
NSX160DC	125	530							2.5	1.5	3	1.5	3.1	2	4	2.5	4	3	6			
	TM-G 3P3D		160	530						2.5	1.5	3	1.5	3.1	2	4	2.5	4	3	6		
NSX250DC	200	1000							2.5	1.5	3	1.5	3.1	2	4	2.5	4	3	6			
	TM-DC		2000								3		3.1		4	2.5	4	3	6			
		3P3D <sup>[1]</sup>		250	1250									3.1		4	2.5	4	3	6		
					2500									3.1		4	4	4	3	6		
NSX250DC	200	530						1.25	2.5	1.5	3	1.5	3.1	2	4	2.5	4	3	6			
TM-G 3P3D	250	625						1.25	2.5	1.5	3	1.5	3.1	2	4	2.5	4	3	6			

[1] Type of circuit breaker (1P1D, 2P2D) depend on earthing system and circuit breaker ranges.

For voltage up to 60Vdc one single pole of iC60 C120 NG125 NSX range is enough to break the current.

For ranges with 3P or 4P breakers only (NSX250 for example), one or two poles only are used of a 3P circuit breaker.

[2] According to the voltage and nb of pole used, the breaking capacity can be changed.

Selectivity limit is the minimum of the value indicated in the table and the breaking capacity of downstream circuit breaker.

[3] This table is applicable for Case 1, Case 2, Case 3, Case 4 defined in introduction with this voltage between + and -.

Selectivity limits in this table for case 1 and Case 3 can also apply to system with higher voltage (up to 2 times) for the same circuit breaker (same number of poles used).

Compliance of circuit breakers according to voltage and earthing system shall be checked before using this table.

# Selectivity table

Upstream: Masterpact NW DC

Downstream: iC60, C60H-DC, C120, NG125. Compact NSX100/160/250

U<sub>e</sub>: 110, 125 V DC <sup>[3]</sup>

Time constant: 1.5 ms - 25 ms



Upstream	NW10DC -C N/H					NW10DC -C N/H					NW10DC -C N/H				
						NW20DC -C N/H					NW20DC -C N/H				
						NW40DC-C N/H									
	2P2D														
	Trip unit	Micrologic 1.0 DC													
	Range 1250/2500A					Range 2500/5400A					Range 5000/11000A				
Type	A	B	C	D	E	A	B	C	D	E	A	B	C	D	E
Setting	1250	1500	1600	2000	2500	2500	3300	4000	5000	5400	5kA	8kA	10kA	11kA	11kA

Downstream	Rating	Im	Selectivity limit (kA) <sup>[2]</sup>													
iC60 N/H/L 2x (1P1D or 2P2D) <sup>[1]</sup>	0.5-63		T	T	T	T	T	T	T	T	T	T	T	T	T	T
C60H-DC <sup>[1]</sup>	0.5-63		T	T	T	T	T	T	T	T	T	T	T	T	T	T
C120 N/H	63		T	T	T	T	T	T	T	T	T	T	T	T	T	T
1P1D or 2P2D <sup>[1]</sup>	80		1.25	T	T	T	T	T	T	T	T	T	T	T	T	T
	100		1.25	1.5	T	T	T	T	T	T	T	T	T	T	T	T
	125		1.25	1.5	1.6	T	T	T	T	T	T	T	T	T	T	T
NG125 N/H/L B-C-D Curves	10-50		T	T	T	T	T	T	T	T	T	T	T	T	T	T
	63		T	T	T	T	T	T	T	T	T	T	T	T	T	T
	80		1.25	T	T	T	T	T	T	T	T	T	T	T	T	T
	1P1D or 2P2D <sup>[1]</sup>	100 (N)		1.25	1.5	T	T	T	T	T	T	T	T	T	T	T
125 (N)			1.25	1.5	1.6	T	T	T	T	T	T	T	T	T	T	T
NSX100DC N/H TM-D	16	260	1.25	1.5	1.6	10	T	T	T	T	T	T	T	T	T	T
	25	400	1.25	1.5	1.6	5	10	10	T	T	T	T	T	T	T	T
	32	400	1.25	1.5	1.6	2	5	5	T	T	T	T	T	T	T	T
	40	700		1.5	1.6	2	2.5	2.5	10	T	T	T	T	T	T	T
	50	700		1.5	1.6	2	2.5	2.5	5	T	T	T	T	T	T	T
TM-DC	63	700		1.5	1.6	2	2.5	2.5	3.3	T	T	T	T	T	T	T
	80	800		1.5	1.6	2	2.5	2.5	3.3	4	T	T	T	T	T	T
	100	1000				2	2.5	2.5	3.3	4	5	T	T	T	T	T
NSX100DC TM-G	16	80	1.25	1.5	1.6	10	T	T	T	T	T	T	T	T	T	T
	25	100	1.25	1.5	1.6	5	10	10	T	T	T	T	T	T	T	T
	40	100		1.5	1.6	2	2.5	2.5	10	T	T	T	T	T	T	T
	63	150		1.5	1.6	2	2.5	2.5	3.3	T	T	T	T	T	T	T
	80	250		1.5	1.6	2	2.5	2.5	3.3	4	T	T	T	T	T	T
NSX160DC TM-DC	100	1000				2	2.5	2.5	5	T	T	T	T	T	T	T
	125	1200					2.5	2.5	3.3	10	T	T	T	T	T	T
	160	1250					2.5	2.5	3.3	5	10	T	T	T	T	T
NSX160DC TM-G	125	530	1.25	1.5	1.6	2	2.5	2.5	3.3	10	T	T	T	T	T	T
	160	530	1.25	1.5	1.6	2	2.5	2.5	3.3	5	10	T	T	T	T	T
	NSX250DC TM-DC	200	1000				2	2.5	2.5	5	T	T	T	T	T	T
		2000								4	5	T	T	T	T	T
250		1250					2.5	2.5	3.3	5	10	T	T	T	T	T
NSX250DC TM-G	200	530	1.25	1.5	1.6	2	2.5	2.5	5	T	T	T	T	T	T	T
	250	625		1.5	1.6	2	2.5	2.5	3.3	5	10	T	T	T	T	T

**[1]** Type of circuit breaker (1P1D, 2P2D) depend on earthing system and circuit breaker ranges.  
 For voltage up to 60Vdc one single pole of iC60 C120 NG125 NSX range is enough to break the current.  
 For ranges with 3P or 4P breakers only (NSX250 for example), one or two poles only are used of a 3P circuit breaker.

**[2]** According to the voltage and nb of pole used, the breaking capacity can be changed.  
 Selectivity limit is the minimum of the value indicated in the table and the breaking capacity of downstream circuit breaker.

**[3]** This table is applicable for Case 1, Case 2, Case 3, Case 4 defined in introduction with this voltage between + and -.  
 Selectivity limits in this table for case 1 and Case 3 can also apply to system with higher voltage (up to 2 times) for the same circuit breaker (same number of poles used).

Compliance of circuit breakers according to voltage and earthing system shall be checked before using this table.

# Selectivity table

Upstream: Masterpact NW DC

Downstream: Compact NSX400/630/1200 DC, Masterpact NW DC



Ue: 110, 125 V DC <sup>[3]</sup>

Time constant: 1.5 ms - 25 ms

Upstream	NW10DC -C N/H					NW10DC -C N/H					NW10DC -C N/H				
						NW20DC -C N/H					NW20DC -C N/H				
											NW40DC-C N/H				
	2P2D														
	Trip unit Micrologic 1.0 DC														
	Range 1250/2500A					Range 2500/5400A					Range 5000/11000A				
Type	A	B	C	D	E	A	B	C	D	E	A	B	C	D	E
Setting	1250	1500	1600	2000	2500	2500	3300	4000	5000	5400	5000	8000	10000	11000	11000

Downstream	Rating	Im	Selectivity limit (kA) <sup>[2]</sup>														
NSX400DC	250	635	1.25	1.5	1.6	2	2.5	2.5	3.3	4	5	5.4	5	T	T	T	T
	TM-DC	1250					2.5	2.5	3.3	4	5	5.4	5	T	T	T	T
3P3D <sup>[1]</sup>	320	800			1.6	2	2.5	2.5	3.3	4	5	5.4	5	T	T	T	T
		1600							3.3	4	5	5.4	5	10	T	T	T
	400	1000				2	2.5	2.5	3.3	4	5	5.4	5	10	T	T	T
		2000								4	5	5.4	5	10	T	T	T
NSX630DC	500	1250						2.5	3.3	4	5	5.4	5	T	T	T	T
	TM-DC	2500									5	5.4	5	10	T	T	T
3P3D <sup>[1]</sup>	600	1500							3.3	4	5	5.4	5	10	T	T	T
		3000											10	T	T	T	T
NSX1200DC	630	1575							3.3	4	5	5.4	5	8	10	11	11
	TM-DC	3150												8	10	11	11
3P3D <sup>[1]</sup>	800	2000								4	5	5.4	5	8	10	11	11
		4000												8	10	11	11
	1000	2500										5	8	10	11	11	11
		5000													10	11	11
	1200	3000												8	10	11	11
		6000														11	11
NW DC-C	1000	1250							3.3	4	5	5.4	5	8	10	11	11
		2500									5	5.4	5	8	10	11	11
	1000/2000	2500									5	5.4	5	8	10	11	11
		5400													10	11	11
	1000/2000/4000	5000													10	11	11
		11000															

**[1]** Type of circuit breaker (1P1D, 2P2D) depend on earthing system and circuit breaker ranges.  
 For voltage up to 60Vdc one single pole of iC60 C120 NG125 NSX range is enough to break the current.  
 For ranges with 3P or 4P breakers only (NSX250 for example), one or two poles only are used of a 3P circuit breaker.

**[2]** According to the voltage and nb of pole used, the breaking capacity can be changed.  
 Selectivity limit is the minimum of the value indicated in the table and the breaking capacity of downstream circuit breaker.

**[3]** This table is applicable for Case 1, Case 2, Case 3, Case 4 defined in introduction with this voltage between + and -.  
 Selectivity limits in this table for case 1 and Case 3 can also apply to system with higher voltage (up to 2 times) for the same circuit breaker (same number of poles used).

Compliance of circuit breakers according to voltage and earthing system shall be checked before using this table.

# Selectivity table

Upstream: C120, NG125 curves B, C, D

Downstream: C60H-DC curve C

U<sub>e</sub>: 220, 250 V DC <sup>[3]</sup>

Time constant (L/R): 1.5 ms to 25 ms



Upstream		C120N/H/L, NG125N/H/L, 2P, 3P or 4P <sup>[1]</sup>										
		Curve B										
In (A)		10	16	20	25	32	40	50	63	80	100	125

Downstream	Rating (A)	Selectivity limit (A) <sup>[2]</sup>											
C60H-DC 1P or 2P <sup>[1]</sup> C Curves	0.5	500	T	T	T	T	T	T	T	T	T	T	T
	1		250	500	750	1500	T	T	T	T	T	T	T
	2				600	900	2000	3000	3500	5500	T	T	T
	3						1300	1500	1800	3000	5000	T	T
	4							1000	1200	1700	2800	5000	T
	6									1400	2000	3200	T
	10										1400	2300	T
	16											2000	T
	≥ 20												2000

Upstream		C120N/H/L, NG125N/H/L, 2P, 3P or 4P <sup>[1]</sup>										
		Curve C										
In (A)		10	16	20	25	32	40	50	63	80	100	125

Downstream	Rating (A)	Selectivity limit (A) <sup>[2]</sup>											
C60H-DC 1P or 2P <sup>[1]</sup> C Curves	0.5	T	T	T	T	T	T	T	T	T	T	T	T
	1	300	1700	6000	T	T	T	T	T	T	T	T	T
	2		1000	1600	6000	T	T	T	T	T	T	T	T
	3			1000	3000	4000	5000	T	T	T	T	T	T
	4					2500	3500	2500	4500	T	T	T	T
	6							1000	2500	T	T	T	T
	10								1700	4000	6000	8000	T
	16								1000	2500	4500	6000	T
	20									2000	3500	4500	T
	≥ 32										3000	4000	T

Upstream		C120N/H/L, NG125N/H/L, 2P, 3P or 4P <sup>[1]</sup>										
		Curve D										
In (A)		10	16	20	25	32	40	50	63	80	100	125

Downstream		Selectivity limit (A) <sup>[2]</sup>											
C60H-DC 1P or 2P <sup>[1]</sup> C Curves	0.5	T	T	T	T	T	T	T	T	T	T	T	T
	1	1400	T	T	T	T	T	T	T	T	T	T	T
	2	800	3000	6000	T	T	T	T	T	T	T	T	T
	3			3500	5000	T	T	T	T	T	T	T	T
	4			1000	3000	5000	6000	T	T	T	T	T	T
	6					2000	2500	3500	4500	T	T	T	T
	10							2000	2500	8000	T	T	T
	16									6500	T	T	T
	20									4000	6000	T	T
	25										5500	7500	T
	≥ 40											5000	T

- T Total selectivity.
- 500 Selectivity limit = 500 A.
- No selectivity.

<sup>[1]</sup> Type of circuit breaker depend on earthing system and circuit breaker ranges (see Distribution guide direct current CA908061).

<sup>[2]</sup> According to the voltage and number of pole used, the breaking capacity can be changed. Selectivity limit is the minimum of the value indicated in the table and the breaking capacity of downstream circuit breaker.

<sup>[3]</sup> This table is applicable for Case 1, Case 2, Case 3, Case 4 defined in introduction with this voltage between + and - Selectivity limits in this table for Case 3 and Case 4 can also apply to system with higher voltage (up to 2 times) for the same circuit breaker (same number of poles used).  
Compliance of circuit breakers according to voltage and earthing system shall be checked before using this table.

# Selectivity table

Upstream: Compact NSX100/160/250 TM-D, TM-DC

Downstream: C60H-DC, C120, NG125



Ue: 220-250 V DC <sup>[3]</sup>

Time constant: 1.5 ms - 25 ms

Upstream	NSX100DC								NSX160DC				NSX250 DC							
	1P1D 2P2D F/N/M/S 3P3D F/S <sup>[1]</sup>																			
	Trip unit		TMD, TM-DC								TMD, TM-DC						TM-DC			
	Rating	16	25	32	40	50	63	80	100	100	125	160	160	200	250	3P3D (1 or 2 P used) F/S <sup>[1]</sup>				
	fixed	fixed	fixed	fixed	fixed	fixed	fixed	fixed	fixed	fixed	fixed	fixed	Mini	Maxi	Mini	Maxi				
Im	260	400	550	700	700	800	800	800	800	800	1250	1250	1250	1000	2000	1250	2500			

Downstream	Rating	Selectivity limit (kA) <sup>[2]</sup>																
C60H-DC C Curves	0.5	5	10	10	10	T	T	T	T	T	T	T	T	T	T	T	T	
	1	5	5	5	5	10	T	T	T	T	T	T	T	T	T	T	T	
	2	0.26	0.4	0.55	0.7	5	T	T	T	T	T	T	T	T	T	T	T	
	1P1D or 2P2D <sup>[1]</sup>	3		0.4	0.55	0.7	0.7	T	T	T	T	T	T	T	T	T	T	T
		4			0.55	0.7	0.7	10	T	T	T	T	T	T	T	T	T	T
		5				0.7	0.7	10	10	T	T	T	T	T	T	T	T	T
		6					0.7	5	10	10	10	T	T	T	T	T	T	T
		10					0.7	5	5	5	5	T	T	T	T	T	T	T
		13						0.7	0.8	5	5	10	T	T	10	T	T	T
		15-16							0.8	0.8	5	10	10	10	5	T	T	T
		20								0.8	0.8	5	5	5	1	T	T	T
		25								0.8	0.8	5	5	5	1	T	T	T
		30-32										5	5	5		T	10	T
		40											5	5		T	5	T
		50														10		10
		63														5		5
	C120 N/H B-C-D Curves	63											1.25	1.25		5	10	T
80															2		T	
2P2D or 4P4D <sup>[1]</sup>		100														2		T
		125																T
NG125 N/H/L B-C-D Curves	10		0.4	0.5	0.7	0.7	0.7	0.8	0.8	0.8	10	10	10	5	T	T	T	
	2P2D or 4P4D <sup>[1]</sup>	16			0.5	0.7	0.7	0.7	0.8	0.8	0.8	10	10	10	1	T	T	T
		20				0.7	0.7	0.7	0.8	0.8	0.8	10	10	10	1	T	T	T
	25					0.7	0.8	0.8	0.8	0.8	5	10	10	1	T	T	T	
	32						0.8	0.8	0.8	0.8	1.25	5	5	1	T	T	T	
	40							0.8	0.8	0.8	1.25	1.25	1.25	1	10	T	T	
	50									1.25	1.25	1.25	1	5	T	T		
	63										1.25	1.25		5	10	T		
	80													2		T		
	100 (N)													2		T		
	125 (N)																T	

[1] Type of circuit breaker (1P1D, 2P2D) depend on earthing system and circuit breaker ranges.

For voltage up to 60Vdc one single pole of iC60 C120 NG125 NSX range is enough to break the current.

For ranges with 3P or 4P breakers only (NSX250 for example), one or two poles only are used of a 3P circuit breaker.

[2] According to the voltage and nb of pole used, the breaking capacity can be changed.

Selectivity limit is the minimum of the value indicated in the table and the breaking capacity of downstream circuit breaker.

[3] This table is applicable for Case 1, Case 2, Case 3, Case 4 defined in introduction with this voltage between + and -.

Selectivity limits in this table for case 1 and Case 3 can also apply to system with higher voltage (up to 2 times) for the same circuit breaker (same number of poles used).

Compliance of circuit breakers according to voltage and earthing system shall be checked before using this table.



# Selectivity table

Upstream: Compact NSX100/160/250 DC TM-G

Downstream: C60H-DC, NG125

U<sub>e</sub>: 220-250 V DC <sup>[3]</sup>

Time constant: 1.5 ms - 25 ms



Upstream	NSX100DC						NSX160DC			NSX250 DC			
	3P3D (1 or 2 P used) F/S <sup>[1]</sup>												
	Trip unit	TM-G						TM-G			TM-G		
	Rating	16	25	40	63	80	100	100	125	160	160	200	250
I <sub>m</sub>	80	100	100	150	250	400	400	530	530	530	530	530	625

Downstream	In	Selectivity limit (kA) <sup>[2]</sup>											
<b>C60H-DC</b>	0.5	5	5	5	5	5	5	5	T	T	T	T	T
C Curves	1	0.08	0.1	0.1	0.15	0.25	5	5	10	T	T	T	T
<b>1P1D or 2P2D</b>	2		0.1	0.1	0.15	0.25	0.4	0.4	10	10	10	T	T
<sup>[1]</sup>	3			0.1	0.15	0.25	0.4	0.4	5	10	10	10	T
	4				0.15	0.25	0.4	0.4	0.53	5	5	5	10
	5					0.25	0.4	0.4	0.53	0.53	0.53	0.53	5
	6						0.4	0.4	0.53	0.53	0.53	0.53	0.63
	10								0.53	0.53	0.53	0.53	0.63
	13								0.53	0.53	0.53	0.53	0.63
	15-16								0.53	0.53	0.53	0.53	0.63
	20								0.53	0.53	0.53	0.53	0.63
	25									0.53	0.53	0.53	0.63
	30-32												0.63
	40												
	50												
	63												
<b>NG125 N/H/L</b>	10												
B-C-D Curves	16												
<b>2P2D or 4P4D</b>	20												
<sup>[1]</sup>	25												
	32												
	40												

**[1]** Type of circuit breaker (1P1D, 2P2D) depend on earthing system and circuit breaker ranges.  
 For voltage up to 60Vdc one single pole of iC60 C120 NG125 NSX range is enough to break the current.  
 For ranges with 3P or 4P breakers only (NSX250 for example), one or two poles only are used of a 3P circuit breaker.

**[2]** According to the voltage and nb of pole used, the breaking capacity can be changed.  
 Selectivity limit is the minimum of the value indicated in the table and the breaking capacity of downstream circuit breaker.

**[3]** This table is applicable for Case 1, Case 2, Case 3, Case 4 defined in introduction with this voltage between + and -.  
 Selectivity limits in this table for case 1 and Case 3 can also apply to system with higher voltage (up to 2 times) for the same circuit breaker (same number of poles used).

Compliance of circuit breakers according to voltage and earthing system shall be checked before using this table.

# Selectivity table

Upstream: Compact NSX100 - 250 DC TMD

Downstream: Compact NSX100 - 160 DC TMD, TMG



Ue: 220-250 V DC <sup>[3]</sup>

Time constant: 1.5 ms - 25 ms

Upstream	NSX100 DC								NSX160 DC				NSX250 DC				
	1P1D 2P2D F/N/M/S (3P3D F/S) <sup>[1]</sup>																
	Trip unit	TM-D								TM-D, TM-DC				TM-DC			
	Rating	16	25	32	40	50	63	80	100	80	100	125	160	160	200	250	
Im	fixed	fixed	fixed	fixed	fixed	fixed	fixed	fixed	fixed	fixed	fixed	fixed	fixed	Mini	Maxi	Mini	Maxi
	260	400	550	700	700	700	640	800	640	800	1250	1250	1250	1000	2000	1250	2500

Downstream	Rating	Im	Selectivity limit (kA) <sup>[2]</sup>																
<b>NSX100DC</b>	16	260			0.5	0.7	0.7	0.7	0.7	0.8	0.8	0.8	1.25	1.25	1.25	1	2	1.25	5
<b>TM-D</b>	25	400				0.7	0.7	0.7	0.7	0.8	0.8	0.8	1.25	1.25	1.25	1	2	1.25	5
<b>(TM-DC)</b>	32	400						0.7	0.7	0.8	0.8	0.8	1.25	1.25	1.25	1	2	1.25	5
<b>1P1D or 2P2PD (3P3D) <sup>[1]</sup></b>	40	700						0.7	0.8	0.8	0.8	1.25	1.25	1.25	1	2	1.25	2.5	
	50	700						0.7	0.8	0.8	0.8	1.25	1.25	1.25	1	2	1.25	2.5	
	63	700							0.8		0.8	1.25	1.25	1.25	1	2	1.25	2.5	
	80	800										1.25	1.25	1.25	1	2	1.25	2.5	
	100	1000										1.25	1.25	1.25	1	2	1.25	2.5	
<b>NSX100DC</b>	16	80			0.5	0.7	0.7	0.7	0.7	0.8	0.8	0.8	1.25	1.25	1.25	1	2	1.25	10
<b>TM-G</b>	25	100				0.7	0.7	0.7	0.7	0.8	0.8	0.8	1.25	1.25	1.25	1	2	1.25	5
<b>3P3D <sup>[1]</sup></b>	40	100							0.7	0.8	0.8	0.8	1.25	1.25	1.25	1	2	1.25	5
	63	150							0.7	0.8		0.8	1.25	1.25	1.25	1	2	1.25	5
	80	250								0.8			1.25	1.25	1.25	1	2	1.25	2.5
	100	400											1.25	1.25	1.25	1	2	1.25	2.5
<b>NSX160DC</b>	100	1000											1.25	1.25	1.25	1	2	1.25	2.5
<b>TM-DC</b>	125	1200																1.25	2.5
<b>1P1D or 2P2D 3P2D <sup>[1]</sup></b>	160	1250																	
<b>NSX160DC</b>	125	530																1.25	2.5
<b>TM-G 3P3D <sup>[1]</sup></b>	160	530																	

**[1]** Type of circuit breaker (1P1D, 2P2D) depend on earthing system and circuit breaker ranges.  
 For voltage up to 60Vdc one single pole of iC60 C120 NG125 NSX range is enough to break the current.  
 For ranges with 3P or 4P breakers only (NSX250 for example), one or two poles only are used of a 3P circuit breaker.

**[2]** According to the voltage and nb of pole used, the breaking capacity can be changed.  
 Selectivity limit is the minimum of the value indicated in the table and the breaking capacity of downstream circuit breaker.

**[3]** This table is applicable for Case 1, Case 2, Case 3, Case 4 defined in introduction with this voltage between + and -.  
 Selectivity limits in this table for case 1 and Case 3 can also apply to system with higher voltage (up to 2 times) for the same circuit breaker (same number of poles used).

Compliance of circuit breakers according to voltage and earthing system shall be checked before using this table.

# Selectivity table

Upstream: Compact NSX400/630/1200 DC TM-DC

Downstream: C60H-DC, C120, NG125

Ue: 220-250 V DC [3]

Time constant: 1.5 ms - 25 ms



Upstream	NSX400DC F/S						NSX630DC F/S				NSX1200DC N								
	3P3D (1 or 2 P Used) [1]										2P2D								
	Trip unit	TM-DC						TM-DC				TM-DC							
		250		320		400		500		600		630		800		1000		1200	
Rating	min	max	min	max	min	max	min	max	min	max	min	max	min	max	min	max	min	max	
Downstream	Im	625	1250	800	1600	1000	2000	1250	2500	1500	3000	1575	3150	2000	4000	2500	5000	3000	6000

Downstream	In	Selectivity limit (kA) [2]																	
<b>C60H-DC</b>	0.5	T	T	T	T	T	T	T	T	T	T	T	T	T	T	T	T	T	T
C curve	1	T	T	T	T	T	T	T	T	T	T	T	T	T	T	T	T	T	T
<b>1P1D or 2P2D</b>	2	T	T	T	T	T	T	T	T	T	T	T	T	T	T	T	T	T	T
[1]	3	T	T	T	T	T	T	T	T	T	T	T	T	T	T	T	T	T	T
	4	15	T	T	T	T	T	T	T	T	T	T	T	T	T	T	T	T	T
	5	10	T	T	T	10	T	T	T	T	T	T	T	T	T	T	T	T	T
	6	5	T	15	T	5	T	T	T	T	T	T	T	T	T	T	T	T	T
	10	0.6	T	10	T	1	T	T	T	T	T	T	T	T	T	T	T	T	T
	13		10	5	10		10	10	T	10	T	10	T	10	T	T	T	T	T
	15-16		5	0.8	5		5	5	T	5	T	5	T	5	T	T	T	T	T
	20		1.25		1.6		5	1.25	T	1.5	T	1.5	T	5	T	T	T	T	T
	25						2		T		T		T	2	T	T	T	T	T
	30-32								T		T		T		T	T	T	T	T
	40								T		T		T		T	T	T	T	T
	50								T		T		T		T	T	T	T	T
	63								T		T		T		T	T	T	T	T
<b>NG125 N/H/L</b>	10	0.625	1.25	0.8	1.6	1	5	T	T	10	T	10	T	T	T	T	T	T	T
B-C-D Curves	16				1.6	1	2	5	T	5	T	5	T	T	T	T	T	T	T
<b>2P2D or 4P4D</b>	20						2	1.25	T	1.5	T	1.5	T	T	T	T	T	T	T
[1]	25								T		T		T	T	T	T	T	T	T
	32								T		T		T	10	T	T	T	T	T
	40								T		T		T	10	T	10	T	T	T
	50								T		T		T	5	T	10	T	T	T
	63								T		T		T		5	T	T	T	T
	80								5		T		T		T		T	T	T
	100 (N)								5		10		10		10		T	T	T
	125 (N)								5		5		5		5		T	T	T
<b>C120 N/H</b>	63								T		T		T		T	5	T	T	T
B-C-D Curves	80								5		T		T		T		T	T	T
<b>2P2D or 4P4D</b>	100								5		10		10		10		T	T	T
[1]	125								5		5		5		5		T	T	T

[1] Type of circuit breaker (1P1D, 2P2D) depend on earthing system and circuit breaker ranges.

For voltage up to 60Vdc one single pole of iC60 C120 NG125 NSX range is enough to break the current.

For ranges with 3P or 4P breakers only (NSX250 for example), one or two poles only are used of a 3P circuit breaker.

[2] According to the voltage and nb of pole used, the breaking capacity can be changed.

Selectivity limit is the minimum of the value indicated in the table and the breaking capacity of downstream circuit breaker.

[3] This table is applicable for Case 1, Case 2, Case 3, Case 4 defined in introduction with this voltage between + and -.

Selectivity limits in this table for case 1 and Case 3 can also apply to system with higher voltage (up to 2 times) for the same circuit breaker (same number of poles used).

Compliance of circuit breakers according to voltage and earthing system shall be checked before using this table.

# Selectivity table

Upstream: Compact NSX400/630/1200 DC TM-DC

Downstream: Compact NSX100/160 DC TM-D, TM-DC, TM-G



U<sub>e</sub>: 220-250 V DC <sup>[3]</sup>

Time constant: 1.5 ms - 25 ms

Upstream	Trip unit	NSX400DC F/S						NSX630DC F/S				NSX1200DC N							
		TM-DC						TM-DC				TM-DC							
		250		320		400		500		600		630		800		1000		1200	
		min	max	min	max	min	max	min	max	min	max	min	max	min	max	min	max	min	max
	I <sub>m</sub>	625	1250	800	1600	1000	2000	1250	2500	1500	3000	1575	3150	2000	4000	2500	5000	3000	6000

Downstream	Rating	I <sub>m</sub>	Selectivity limit (kA) <sup>[2]</sup>																	
<b>NSX100DC</b>	16	260	0.63	1.25	0.8	1.6	1	2	1.25	2.5	1.5	3	1.5	3.1	2	4	2.5	5	3	T
<b>TM-D</b>	25	400	0.63	1.25	1	1.6	1	2	1.25	2.5	1.5	3	1.5	3.1	2	4	2.5	5	3	10
<b>(TM-DC)</b>	32	400		1.25	1	1.6	1	2	1.25	2.5	1.5	3	1.5	3.1	2	4	2.5	5	3	6
<b>1P1D or 2P2PD (3P3D)</b>	40	700			1	1.6	1	2	1.25	2.5	1.5	3	1.5	3.1	2	4	2.5	5	3	6
	50	700				1.6	1	2	1.25	2.5	1.5	3	1.5	3.1	2	4	2.5	5	3	6
	63	700					1	2	1.25	2.5	1.5	3	1.5	3.1	2	4	2.5	5	3	6
	80	800						2		2.5		3	1.5	3.1	2	4	2.5	5	3	6
	100	1000						2		2.5		3		3.1	2	4	2.5	5	3	6
<b>NSX100DC</b>	16	80	0.63	1.25	0.8	1.6	1	2	1.25	2.5	1.5	3	1.5	3.1	2	4	2.5	5	3	T
<b>TM-G</b>	25	100	0.63	1.25	1	1.6	1	2	1.25	2.5	1.5	3	1.5	3.1	2	4	2.5	5	3	10
<b>3P3D <sup>[1]</sup></b>	40	100			1	1.6	1	2	1.25	2.5	1.5	3	1.5	3.1	2	4	2.5	5	3	6
	63	150					1	2	1.25	2.5	1.5	3	1.5	3.1	2	4	2.5	5	3	6
	80	250						2		2.5		3	1.5	3.1	2	4	2.5	5	3	6
	100	400						2		2.5		3	1.5	3.1	2	4	2.5	5	3	6
<b>NSX160DC</b>	100	1000						2		2.5		3	1.5	3.1	2	4	2.5	5	3	6
<b>TM-DC</b>	125	1200								2.5		3		3.1		4	2.5	4	3	6
<b>1P1D or 2P2PD</b>	160	1250								2.5		3		3.1		4	2.5	4	3	6
<b>NSX160DC</b>	125	530								2.5	1.5	3	1.5	3.1	2	4	2.5	4	3	6
<b>TM-G 3P3D</b>	160	530								2.5	1.5	3	1.5	3.1	2	4	2.5	4	3	6
<b>NSX250DC</b>	200	1000								2.5	1.5	3	1.5	3.1	2	4	2.5	4	3	6
<b>TM-DC</b>		2000										3		3.1		4	2.5	4	3	6
<b>3P3D <sup>[1]</sup></b>	250	1250												3.1		4	2.5	4	3	6
		2500												3.1		4		4	3	6
<b>NSX250DC</b>	200	530							1.25	2.5	1.5	3	1.5	3.1	2	4	2.5	4	3	6
<b>TM-G 3P3D</b>	250	625							1.25	2.5	1.5	3	1.5	3.1	2	4	2.5	4	3	6

[1] Type of circuit breaker (1P1D, 2P2D) depend on earthing system and circuit breaker ranges.

For voltage up to 60Vdc one single pole of iC60 C120 NG125 NSX range is enough to break the current.

For ranges with 3P or 4P breakers only (NSX250 for example), one or two poles only are used of a 3P circuit breaker.

[2] According to the voltage and nb of pole used, the breaking capacity can be changed.

Selectivity limit is the minimum of the value indicated in the table and the breaking capacity of downstream circuit breaker.

[3] This table is applicable for Case 1, Case 2, Case 3, Case 4 defined in introduction with this voltage between + and -.

Selectivity limits in this table for case 1 and Case 3 can also apply to system with higher voltage (up to 2 times) for the same circuit breaker (same number of poles used).

Compliance of circuit breakers according to voltage and earthing system shall be checked before using this table.

# Selectivity table

Upstream: Masterpact NW DC

Downstream: C60H-DC, C120, NG125. Compact NSX100/160/250 DC

Ue: 220-250 V DC [3]

Time constant: 1.5 ms - 25 ms



Upstream	NW10DC -C N/H					NW10DC -C N/H					NW10DC -C N/H									
						NW20DC -C N/H					NW20DC -C N/H									
											NW40DC-C N/H									
	2P2D																			
	Trip unit					Micrologic 1.0 DC														
					Range 1250/2500A					Range 2500/5400A					Range 5000/11000A					
Type	A	B	C	D	E	A	B	C	D	E	A	B	C	D	E					
Setting	1250	1500	1600	2000	2500	2500	3300	4000	5000	5400	5kA	8kA	10kA	11kA	11kA					

Downstream	Rating	Im	Selectivity limit (kA) [2]														
<b>C60H-DC</b> [1]	0.5-63		T	T	T	T	T	T	T	T	T	T	T	T	T	T	T
<b>C120 N/H</b>	63		T	T	T	T	T	T	T	T	T	T	T	T	T	T	T
<b>2P/2P or 4P4D</b>	80		1.25	T	T	T	T	T	T	T	T	T	T	T	T	T	T
[1]	100		1.25	1.5	T	T	T	T	T	T	T	T	T	T	T	T	T
	125		1.25	1.5	1.6	T	T	T	T	T	T	T	T	T	T	T	T
<b>NG125 N/H/L</b>	10-50		T	T	T	T	T	T	T	T	T	T	T	T	T	T	T
B-C-D Curves	63		T	T	T	T	T	T	T	T	T	T	T	T	T	T	T
<b>2P/2P or 4P4D</b>	80		1.25	T	T	T	T	T	T	T	T	T	T	T	T	T	T
[1]	100 (N)		1.25	1.5	T	T	T	T	T	T	T	T	T	T	T	T	T
	125 (N)		1.25	1.5	1.6	T	T	T	T	T	T	T	T	T	T	T	T
<b>NSX100DC N/H</b>	16	260	1.25	1.5	1.6	2	2.5	2.5	10	T	T	T	T	T	T	T	T
<b>TM-D</b>	25	400	1.25	1.5	1.6	2	2.5	2.5	5	T	T	T	T	T	T	T	T
	32	400	1.25	1.5	1.6	2	2.5	2.5	3.3	10	T	T	T	T	T	T	T
<b>1P1D or 2P2D</b>	40	700		1.5	1.6	2	2.5	2.5	3.3	5	10	T	10	T	T	T	T
[1]	50	700		1.5	1.6	2	2.5	2.5	3.3	4	5	T	5	T	T	T	T
	63	700		1.5	1.6	2	2.5	2.5	3.3	4	5	10	5	T	T	T	T
<b>TM-DC</b>	80	800		1.5	1.6	2	2.5	2.5	3.3	4	5	5.4	5	T	T	T	T
[1]	100	1000				2	2.5	2.5	3.3	4	5	5.4	5	T	T	T	T
<b>NSX100DC</b>	16	80	1.25	1.5	1.6	2	2.5	2.5	10	T	T	T	T	T	T	T	T
<b>TM-G</b>	25	100	1.25	1.5	1.6	2	2.5	2.5	5	T	T	T	T	T	T	T	T
[1]	40	100		1.5	1.6	2	2.5	2.5	3.3	5	10	T	10	T	T	T	T
<b>3P3D</b>	63	150		1.5	1.6	2	2.5	2.5	3.3	4	5	10	5	T	T	T	T
	80	250		1.5	1.6	2	2.5	2.5	3.3	4	5	5.4	5	T	T	T	T
	100	400				2	2.5	2.5	3.3	4	5	5.4	5	T	T	T	T
<b>NSX160DC</b>	100	1000				2	2.5	2.5	3.3	4	5	5.4	5	T	T	T	T
<b>TM-DC 1P1D or 2P2D</b>	125	1200					2.5	2.5	3.3	4	5	5.4	5	T	T	T	T
[1]	160	1250					2.5	2.5	3.3	4	5	5.4	5	T	T	T	T
<b>NSX160DC</b>	125	530	1.25	1.5	1.6	2	2.5	2.5	3.3	4	5	5.4	5	T	T	T	T
<b>TM-G 3P3D</b>	160	530	1.25	1.5	1.6	2	2.5	2.5	3.3	4	5	5.4	5	T	T	T	T
<b>NSX250DC</b>	200	1000				2	2.5	2.5	5	4	5	5.4	5	T	T	T	T
<b>TM-DC</b>		2000								4	5	5.4	5	T	T	T	T
[1]	250	1250					2.5	2.5	3.3	4	5	5.4	5	T	T	T	T
<b>3P3D</b>		2500						2.5	3.3	4	5	5.4	5	T	T	T	T
<b>NSX250DC</b>	200	530	1.25	1.5	1.6	2	2.5	2.5	5	4	5	5.4	5	T	T	T	T
<b>TM-G</b>	250	625		1.5	1.6	2	2.5	2.5	3.3	4	5	5.4	5	T	T	T	T

[1] Type of circuit breaker (1P1D, 2P2D) depend on earthing system and circuit breaker ranges.  
 For voltage up to 60Vdc one single pole of iC60 C120 NG125 NSX range is enough to break the current.  
 For ranges with 3P or 4P breakers only (NSX250 for example), one or two poles only are used of a 3P circuit breaker.  
 [2] According to the voltage and nb of pole used, the breaking capacity can be changed.  
 Selectivity limit is the minimum of the value indicated in the table and the breaking capacity of downstream circuit breaker.  
 [3] This table is applicable for Case 1, Case 2, Case 3, Case 4 defined in introduction with this voltage between + and -.  
 Selectivity limits in this table for case 1 and Case 3 can also apply to system with higher voltage (up to 2 times) for the same circuit breaker (same number of poles used).

Compliance of circuit breakers according to voltage and earthing system shall be checked before using this table.

# Selectivity table

Upstream: Masterpact NW DC

Downstream: Compact NSX400/630/1200 DC, Masterpact NW DC

U<sub>e</sub>: 220-250 V DC <sup>[3]</sup>

Time constant: 1.5 ms - 25 ms

A

Upstream	NW10DC -C N/H					NW10DC -C N/H					NW10DC -C N/H				
						NW20DC -C N/H					NW20DC -C N/H				
											NW40DC-C N/H				
	2P2D														
Trip unit	Micrologic 1.0 DC														
	Range 1250/2500A					Range 2500/5400A					Range 5000/11000A				
Type	A	B	C	D	E	A	B	C	D	E	A	B	C	D	E
Setting	1250	1500	1600	2000	2500	2500	3300	4000	5000	5400	5000	8000	10000	11000	11000

Downstream	Rating	I <sub>m</sub>	Selectivity limit (kA) <sup>[2]</sup>														
NSX400DC	250	635	1.25	1.5	1.6	2	2.5	2.5	3.3	4	5	5.4	5	T	T	T	T
	TM-DC	1250					2.5	2.5	3.3	4	5	5.4	5	T	T	T	T
3P3D <sup>[1]</sup>	320	800			1.6	2	2.5	2.5	3.3	4	5	5.4	5	T	T	T	T
		1600							3.3	4	5	5.4	5	10	T	T	T
	400	1000				2	2.5	2.5	3.3	4	5	5.4	5	10	T	T	T
		2000								4	5	5.4	5	10	10	11	11
NSX630DC	500	1250						2.5	3.3	4	5	5.4	5	10	10	11	11
	TM-DC	2500									5	5.4	5	10	10	11	11
3P3D <sup>[1]</sup>	600	1500							3.3	4	5	5.4	5	10	10	11	11
		3000												10	10	11	11
NSX1200DC	630	1575							3.3	4	5	5.4	5	8	10	11	11
	TM-DC	3150												8	10	11	11
3P3D <sup>[1]</sup>	800	2000								4	5	5.4	5	8	10	11	11
		4000												8	10	11	11
	1000	2500											5	8	10	11	11
		5000													10	11	11
	1200	3000												8	10	11	11
		6000														11	11
Masterpact NW DC-C	1000	1250							3.3	4	5	5.4	5	8	10	11	11
		2500									5	5.4	5	8	10	11	11
	1000/2000	2500									5	5.4	5	8	10	11	11
		5400													10	11	11
	1000/2000/4000	5000													10	11	11
		11000															11

[1] Type of circuit breaker (1P1D, 2P2D) depend on earthing system and circuit breaker ranges.

For voltage up to 60Vdc one single pole of iC60 C120 NG125 NSX range is enough to break the current.

For ranges with 3P or 4P breakers only (NSX250 for example), one or two poles only are used of a 3P circuit breaker.

[2] According to the voltage and nb of pole used, the breaking capacity can be changed.

Selectivity limit is the minimum of the value indicated in the table and the breaking capacity of downstream circuit breaker.

[3] This table is applicable for Case 1, Case 2, Case 3, Case 4 defined in introduction with this voltage between + and -.

Selectivity limits in this table for case 1 and Case 3 can also apply to system with higher voltage (up to 2 times) for the same circuit breaker (same number of poles used).

Compliance of circuit breakers according to voltage and earthing system shall be checked before using this table.

# Selectivity with fuses - Introduction

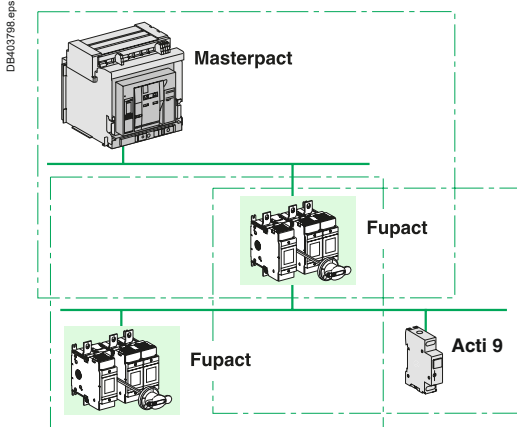

## Principle

### Schneider Electric offers a coordinated protection system

In an electrical installation, protection fuses are never used alone and must always be integrated in a system comprising circuit breakers.

Coordination is required between:

- upstream and downstream fuses
- upstream circuit breakers and downstream fuses
- upstream fuses and downstream circuit breakers.

### Upstream fuse / Downstream fuse

Selectivity is ensured when

**Total energy of downstream fuse ( $E_{tav}$ ) < Pre-arcing energy of upstream fuse ( $E_{pam}$ )**

**Note:** If  $E_{tav}$  is higher than 80 % of  $E_{pam}$ , the upstream fuse may be derated.

### ■ Upstream gG fuse-link / downstream gG fuse-link

Standard IEC 60269-2-1 indicates limit values for pre-arcing and total energies for operation of gG and gM fuse-links, where the operating current is approximately 30 In.

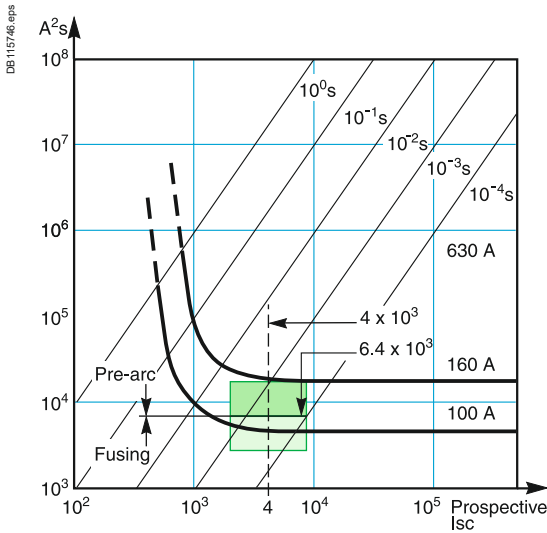

Curves  $E = f(I)$  superimposed.

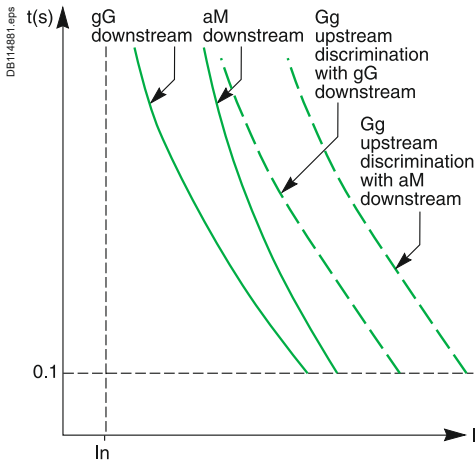

$I = f(t)$  curves.

## $I^2t$ limit and test currents for verification of selectivity

$I_n$ (A)	Minimum values of pre-arcing $I^2t$		Maximum values of operating $I^2t$	
	Rms values of $I$ prospective (kA)	$I^2t$ (A²s)	Rms values of $I$ prospective (kA)	$I^2t$ (A²s)
16	0.27	291	0.55	1 210
20	0.40	640	0.79	2 500
25	0.55	1 210	1.00	4 000
32	0.79	2 500	1.20	5 750
40	1.00	4 000	1.50	9 000
50	1.20	5 750	1.85	13 700
63	1.50	9 000	2.30	21 200
80	1.85	13 700	3.00	36 000
100	2.30	21 200	4.00	64 000
125	3.00	36 000	5.10	104 000
160	4.00	64 000	6.80	185 000
200	5.10	104 000	8.70	302 000
250	6.80	185 000	11.80	557 000
315	8.70	302 000	15.00	900 000
400	11.80	557 000	20.00	1 600 000
500	15.00	900 000	26.00	2 700 000
630	20.00	1 600 000	37.00	5 470 000
800	26.00	2 700 000	50.00	10 000 000
1000	37.00	5 470 000	66.00	17 400 000
1250	50.00	10 000 000	90.00	33 100 000

### ■ Upstream gG fuse-link / downstream aM fuse-link

The  $I = f(t)$  curve for an aM fuse-link is steeper. aM fuse-links are just as fast as gG fuse-links for short-circuit currents, but slower for low overloads.

That is why the selectivity ratio between gG and aM fuse-links is approximately 2.5 to 4.

# Selectivity with fuses - Introduction

A

DB125650.eps

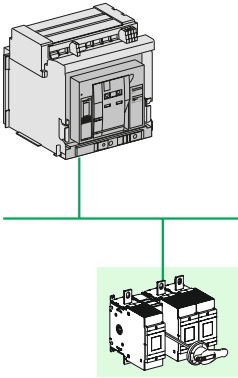

## Upstream circuit breaker / Downstream fuse

### Upstream circuit breaker with delayed ST (short time) protection function

This is the situation for a MLVS (main low-voltage switchboard) or sub-distribution switchboard protected by an incoming circuit breaker.

The upstream circuit breaker has an electrodynamic withstand capacity  $I_{cw}$  and ensures time selectivity.

#### Rule

Examination of selectivity at the critical points on the LT (long time) and ST (short time) curves results in a selectivity table.

Analysis of the LT critical point indicates whether selectivity between the protection devices is possible or not.

Analysis of the ST (or  $I_{cw}$ ) critical point indicates whether the selectivity limit is greater than or equal to the ST (or  $I_{cw}$ ) value.

#### Note:

- the LT critical point is the most restrictive
- for circuit breakers with a  $I_{cw}$  value that is high and/or equal to  $I_{cu}$ , the ST critical point is almost never a problem, i.e. selectivity is total.

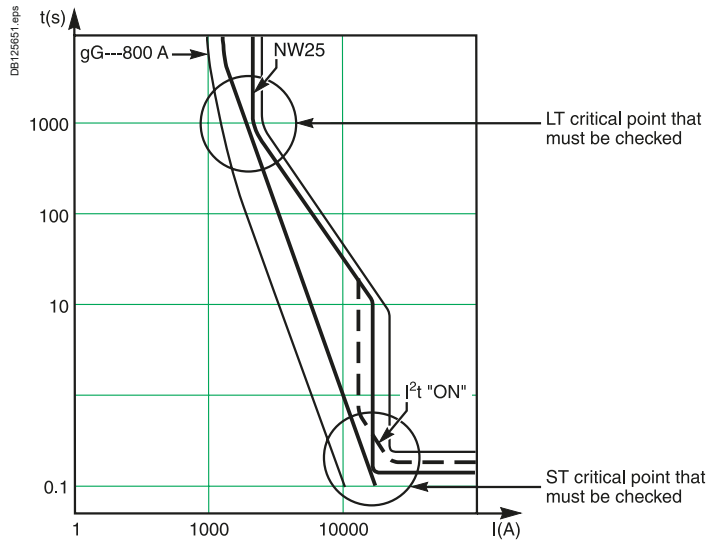

Time-current curves and critical points that must be checked.

### Upstream circuit breaker with non-delayed ST (short time) protection and/or current-limiting function

To make sure the ST critical point is OK, it is necessary to compare:

- the energy curves of the protection devices
- the non-tripping curves of the upstream circuit breaker and the fusing curves of the downstream fuse, and to run tests for the critical values.

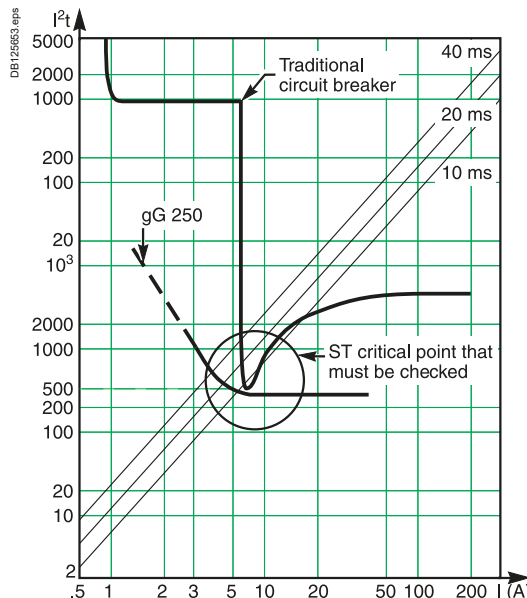

Energy curves and critical points that must be checked.

DB125652.eps

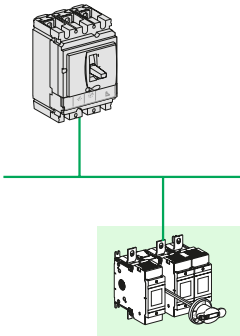



# Selectivity with fuses - Introduction



## I<sup>2</sup>t ON setting

To significantly limit the stresses exerted on the installation (cables installed on trays, power supplied by an engine generator set, etc.), it may be necessary to set the ST protection function to a low value.

The I<sup>2</sup>t ON function, a constant-energy tripping curve, maintains the level of selectivity performance and facilitates total selectivity.

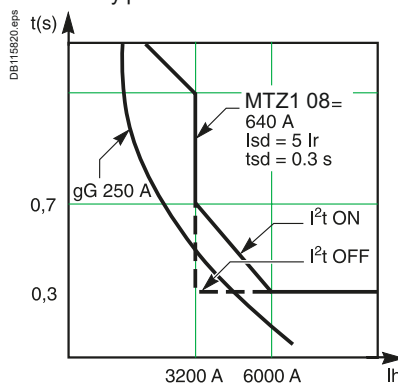

I<sup>2</sup>t ON curve.

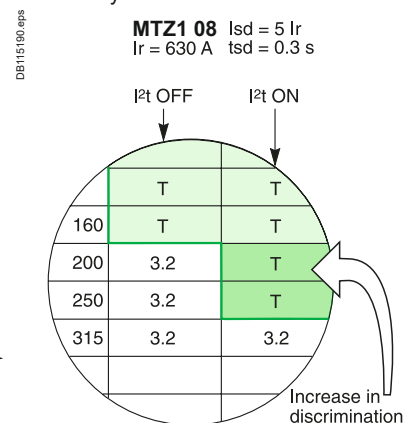

Increase in the selectivity limit.

# Selectivity with fuses - Introduction

A

DB125652.eps

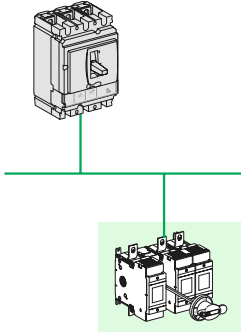

## Compact NSX upstream of gG or aM fuse-links

Compact NSX is a current-limiting circuit breaker. Even without an ST (short time) delay setting, selectivity at the ST critical point is significantly improved because Compact NSX has a mini-delay that considerably increases curve values at the ST critical point.

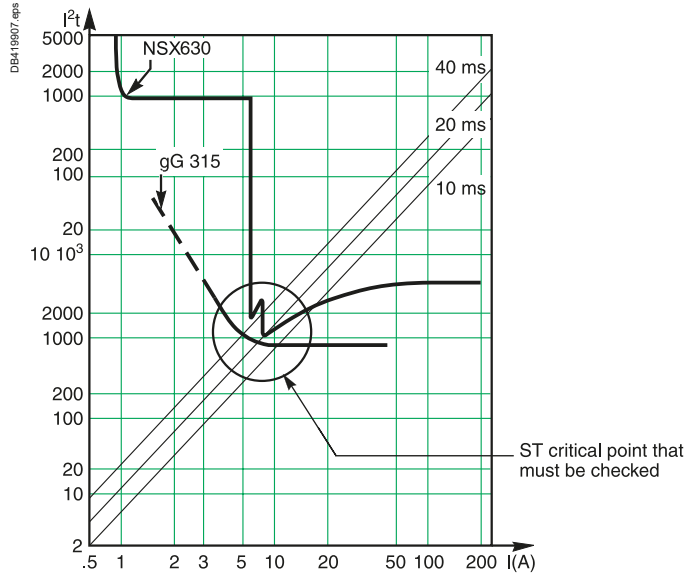

$I^2t$  curve for Compact NSX and a fuse.

See pages A-146 and A-152 for the selectivity tables.

DB125657.eps

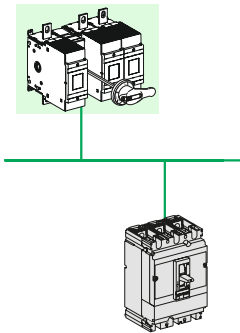

## Compact NSX downstream of gG or aM fuse-links

Compact NSX offers an extremely high level of current-limiting performance due to the piston-based reflex tripping system. Again, selectivity is significantly improved with an upstream fuse.

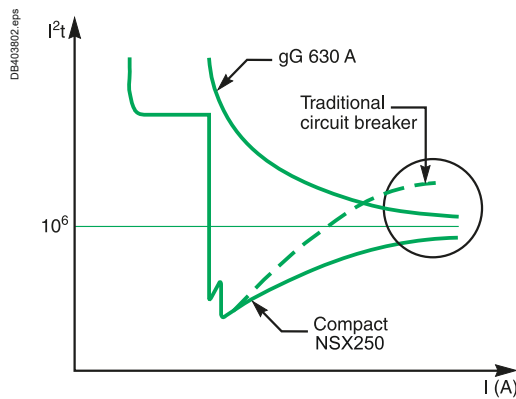

See page A-152 for the selectivity tables.

# Selectivity with fuses - Introduction

Upstream: Fupact (gG fuse-link)

Downstream: Fupact (gG or aM fuse-link)

DE125659.eps

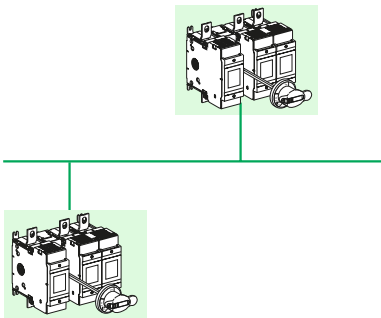

The tables below indicate the necessary ratings for the upstream and downstream fuse-links to achieve **total selectivity**. They take into account the standardised values stipulated in IEC 60269-1 and IEC 60269-2-1 for:

- the pre-arcing energies of the upstream fuse-links
- the total fusing energies of the downstream fuse-links.

Upstream fuse-link gG (In) / gM (Ich)	Downstream fuse-link gG (In) / gM (Ich)	aM (In)
<b>Rating (A)</b>		
16	6	4
20	10	6
25	16	8
32	20	10
40	25	12
50	32	16
63	40	20
80	50	25
100	63	32
125	80	40
160	100	63
200	125	80
250	160	125
315	200	125
400	250	160
500	315	200
630	400	250
800	500	315
1000	630	400
1250	800	500

**Examples:**

- an upstream 125 A gG fuse-link ensures total selectivity with an 80 A gG fuse-link and/or a 40 A aM fuse-link situated downstream
- an upstream 125 A gG fuse-link ensures total selectivity with a 63 A gG 63M80 fuse-link (with an 80 A characteristic) situated downstream.



# Selectivity tables with fuses

Upstream: Masterpact MTZ

Downstream: Fupact (gG or aM fuse-link)

A

Ue ≤ 440 V AC

DB125650.eps

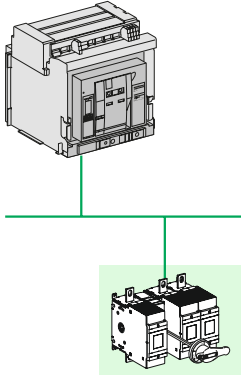

Micrologic settings:  
 ■ LT setting: Tr = 24 seconds.  
 ■ ST setting: instantaneous OFF / Isd = 10 Ir / Tsd = 0.4 seconds.

Upstream	Masterpact MTZ																	
	Micrologic 5.0 X - 6.0 X - 7.0 X																	
	MTZ1	MTZ1	MTZ1	MTZ1	MTZ1	MTZ1	MTZ1	MTZ1	MTZ1	MTZ1	MTZ1	MTZ1	MTZ2	MTZ2	MTZ2	MTZ2	MTZ3	MTZ3
	08 H1	08 H1	08 H1	08 H1	08 H1	08 H1	08 H1	08 H1	10 H1	12 H1	16 H1							
	08	08	08	08	08	08	08	08	10	12	16	20	25	32	40	50	63	
	N1	N1	N1	N1	N1	N1	N1	N1	N1	N1	N1	H1/H2	H1/H2	H1/H2	H1/H2	H1/H2	H1/H2	
	H1/H2	H1/H2	H1/H2	H1/H2	H1/H2	H1/H2	H1/H2	H1/H2	H1/H2	H1/H2	H1/H2	H3	H3	H3	H3			
Down-stream	Rating (A)	400	400	400	630	800	800	800	800	1000	1200	1600	2000	2500	3200	4000	5000	6300
	Ir setting	160	200	240	315	400	480	630	800	1000	1200	1600	2000	2500	3200	4000	5000	6300
gG/aM	32	T	T	T	T	T	T	T	T	T	T	T	T	T	T	T	T	T
Fuse-link	40	T	T	T	T	T	T	T	T	T	T	T	T	T	T	T	T	T
	50	T	T	T	T	T	T	T	T	T	T	T	T	T	T	T	T	T
	63	T	T	T	T	T	T	T	T	T	T	T	T	T	T	T	T	T
	80	T	T	T	T	T	T	T	T	T	T	T	T	T	T	T	T	T
	100	T	T	T	T	T	T	T	T	T	T	T	T	T	T	T	T	T
	125		T	T	T	T	T	T	T	T	T	T	T	T	T	T	T	T
	160			T	T	T	T	T	T	T	T	T	T	T	T	T	T	T
	200				T	T	T	T	T	T	T	T	T	T	T	T	T	T
	250					T	T	T	T	T	T	T	T	T	T	T	T	T
	315						5	T	T	T	T	T	T	T	T	T	T	T
	355								6	T	T	T	T	T	T	T	T	T
	400									8	T	T	T	T	T	T	T	T
	500										T	T	T	T	T	T	T	T
	630											T	T	T	T	T	T	T
	800												12	T	T	T	T	T
	1000													16	T	T	T	T
	1250														20	T	T	T

- 16 Selectivity limit in kA
- T Total selectivity.
- No selectivity.

Note: respect the basic rules of selectivity, in terms of overcurrent, short-circuit, see page A-2, or check curves with curve direct software.

# Selectivity tables with fuses

Upstream: Compact NS630b to 3200

Downstream: Fupact (gG fuse-link)

Ue ≤ 440 V AC

DB125860.eps

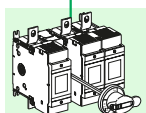
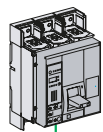

Micrologic settings:

■ LT setting: Tr = 24 seconds.

■ ST setting: instantaneous OFF / Isd = 10 Ir / Tsd = 0.4 seconds.

Upstream		Compact NS L Micrologic 5.0-6.0-7.0								
		NS630b	NS630b	NS630b	NS630b	NS630b	NS630b	NS630b	NS800	NS1000
Down-stream gG Fuse-link	Rating (A)	400	400	400	630	630	630	630	800	1000
	Ir setting	160	200	240	315	400	500	630	800	1000
	32	T	T	T	T	T	T	T	T	T
	40	T	T	T	T	T	T	T	T	T
	50	T	T	T	T	T	T	T	T	T
	63	T	T	T	T	T	T	T	T	T
	80	T	T	T	T	T	T	T	T	T
	100		74	74	74	74	74	74	74	74
	125			41	41	41	41	41	41	41
	160				16	16	16	16	16	16
	200					10	10	10	10	10
	250						10	10	10	10
	315								10	10
	355								10	10
	400									10
	500									
	630									
800										
1000										
1250										

Upstream		Compact NS N/H Micrologic 5.0-6.0-7.0														
		NS630b	NS630b	NS630b	NS630b	NS630b	NS630b	NS630b	NS800	NS1000	NS1250	NS1600	NS1600b	NS2000	NS2500	NS3200
Down-stream gG Fuse-link	Rating (A)	400	400	400	630	630	630	630	800	1000	1200	1600	1600	2000	2500	3200
	Ir setting	160	200	240	315	400	500	630	800	1000	1200	1600	1600	2000	2500	3200
	32	T	T	T	T	T	T	T	T	T	T	T	T	T	T	T
	40	T	T	T	T	T	T	T	T	T	T	T	T	T	T	T
	50	T	T	T	T	T	T	T	T	T	T	T	T	T	T	T
	63	T	T	T	T	T	T	T	T	T	T	T	T	T	T	T
	80	T	T	T	T	T	T	T	T	T	T	T	T	T	T	T
	100		T	T	T	T	T	T	T	T	T	T	T	T	T	T
	125			T	T	T	T	T	T	T	T	T	T	T	T	T
	160				T	T	T	T	T	T	T	T	T	T	T	T
	200					T	T	T	T	T	T	T	T	T	T	T
	250						T	T	T	T	T	T	T	T	T	T
	315								T	T	T	T	T	T	T	T
	355								44	44	44	44	T	T	T	T
	400									35	35	35	T	T	T	T
	500										25	25	T	T	T	T
	630											25	40	40	40	40
800													40	40	40	
1000														40	40	
1250															40	

- 41 Selectivity limit in kA
- T Total selectivity.
- No selectivity.

# Selectivity tables with fuses

Upstream: Compact NSX100 to 630

Downstream: Fupact (gG fuse-link)

A

U<sub>e</sub> ≤ 440 V AC

DB125652.eps

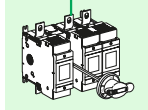
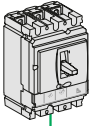

Upstream		NSX100B/F/N/H/S/L								NSX160B/F/N/H/S/L				NSX250B/F/N/H/S/L		
Trip unit		TM-D								TM-D				TM-D		
Down-stream	Rating (A)	100								160				250		
	I <sub>r</sub> setting	16	25	32	40	50	63	80	100	80	100	125	160	160	200	250
	I <sub>m</sub> (kA)	0.19	0.3	0.4	0.5	0.5	0.5	0.63	0.8	1	1	1	1	1	2	2.5
gG Fuse-link	2	T	T	T	T	T	T	T	T	T	T	T	T	T	T	T
	4	T	T	T	T	T	T	T	T	T	T	T	T	T	T	T
	6	T	T	T	T	T	T	T	T	T	T	T	T	T	T	T
	10	T	T	T	T	T	T	T	T	T	T	T	T	T	T	T
	16				T	T	T	T	T	T	T	T	T	T	T	T
	20				T	T	T	T	T	T	T	T	T	T	T	T
	25				T	T	T	T	T	T	T	T	T	T	T	T
	32						T	T	T	T	T	T	T	T	T	T
	35											T	T	T	T	T
	40											T	T	T	T	T
	50											T	T	T	T	T
	63											T	T	T	T	T
	80														T	T
	100														T	T
	125														T	T
	160															T

Upstream		NSX100B/F/N/H/S/L				NSX160B/F/N/H/S/L				NSX250B/F/N/H/S/L			NSX400F/N/H/S/L			NSX630F/N/H/S/L				
Trip unit		Micrologic 2, 5, 6 I <sub>sd</sub> = 10 I <sub>r</sub>				Micrologic 2, 5, 6 I <sub>sd</sub> = 10 I <sub>r</sub>				Micrologic 2, 5, 6 I <sub>sd</sub> = 10 I <sub>r</sub>			Micrologic 2, 5, 6 I <sub>sd</sub> = 10 I <sub>r</sub>			Micrologic 2, 5, 6 I <sub>sd</sub> = 10 I <sub>r</sub>				
Down-stream	Rating (A)	40			100				160			250			400			630		
	I <sub>r</sub> setting	18	25	40	40	63	80	100	100	125	160	160	200	250	250	320	400	400	500	630
	I <sub>m</sub> (kA)		0.25	0.4	0.4	0.63	0.8	1	1	1.25	1.6	1.6	2	2.5	2.5	3.2	4	4	5	6.3
gG Fuse-link	2	T	T	T	T	T	T	T	T	T	T	T	T	T	T	T	T	T	T	T
	4	T	T	T	T	T	T	T	T	T	T	T	T	T	T	T	T	T	T	T
	6	T	T	T	T	T	T	T	T	T	T	T	T	T	T	T	T	T	T	T
	10		T	T	T	T	T	T	T	T	T	T	T	T	T	T	T	T	T	T
	16			T	T	T	T	T	T	T	T	T	T	T	T	T	T	T	T	T
	20				T	T	T	T	T	T	T	T	T	T	T	T	T	T	T	T
	25				T	T	T	T	T	T	T	T	T	T	T	T	T	T	T	T
	32					T	T	T	T	T	T	T	T	T	T	T	T	T	T	T
	35							T	T	T	T	T	T	T	T	T	T	T	T	T
	40							T	T	T	T	T	T	T	T	T	T	T	T	T
	50								T	T	T	T	T	T	T	T	T	T	T	T
	63									T	T	T	T	T	T	T	T	T	T	T
	80										T	T	T	T	T	T	T	T	T	T
	100											T	T	T	T	T	T	T	T	T
	125													T	T	T	T	T	T	T
	160															T	T	T	T	T
200																	T	T	T	
250																		T	T	

# Selectivity tables with fuses

Upstream: Compact NSX100 to 630

Downstream: Fupact (aM fuse-link)

U<sub>e</sub> ≤ 440 V AC

DBI25861.eps

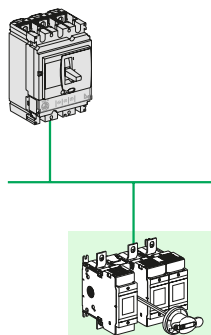

Upstream		NSX100B/F/N/H/S/L							NSX160B/F/N/H/S/L					NSX250B/F/N/H/S/L			
Trip unit		TM-D							TM-D					TM-D			
Down-stream	Rating (A)	16	25	32	40	50	63	80	100	80	100	125	160	160	200	250	
	I <sub>m</sub> (kA)	0.19	0.3	0.4	0.5	0.5	0.5	0.63	0.8	1	1	1	1	1	2	2.5	
aM Fuse-link	2	T	T	T	T	T	T	T	T	T	T	T	T	T	T	T	
	4	T	T	T	T	T	T	T	T	T	T	T	T	T	T	T	
	6	T	T	T	T	T	T	T	T	T	T	T	T	T	T	T	
	10				T	T	T	T	T	T	T	T	T	T	T	T	
	16					T	T	T	T	T	T	T	T	T	T	T	
	20							T	T	T	T	T	T	T	T	T	
	32											T	T	T	T	T	
	35														T	T	
	40															T	T
	50															T	T
	63															T	T

Upstream		NSX100B/F/N/H/S/L							NSX160B/F/N/H/S/L					NSX250B/F/N/H/S/L				
Trip unit		Micrologic							Micrologic					Micrologic				
Down-stream	Rating (A)	40			100				160				250					
	I <sub>m</sub> (kA)	18	25	40	40	63	80	100	63	80	100	125	160	100	125	160	200	250
aM Fuse-link	2	T	T	T	T	T	T	T	T	T	T	T	T	T	T	T	T	T
	4	T	T	T	T	T	T	T	T	T	T	T	T	T	T	T	T	T
	6		T	T	T	T	T	T	T	T	T	T	T	T	T	T	T	T
	10			T	T	T	T	T	T	T	T	T	T	T	T	T	T	T
	16					T	T	T	T	T	T	T	T	T	T	T	T	T
	20						T	T		T	T	T	T	T	T	T	T	T
	32											T	T		T	T	T	T
	35															T	T	T
	40																T	T
	50																T	T
	63																	T

Upstream		NSX400F/N/H/S/L					NSX630F/N/H/S/L					
Trip unit		Micrologic					Micrologic					
Down-stream	Rating (A)	400		250			630			500		630
	I <sub>m</sub> (kA)	160	200	250	320	400	250	320	400	500	630	
aM Fuse-link	2	T	T	T	T	T	T	T	T	T	T	
	4	T	T	T	T	T	T	T	T	T	T	
	6	T	T	T	T	T	T	T	T	T	T	
	10	T	T	T	T	T	T	T	T	T	T	
	16	T	T	T	T	T	T	T	T	T	T	
	20	T	T	T	T	T	T	T	T	T	T	
	32	T	T	T	T	T	T	T	T	T	T	
	35	T	T	T	T	T	T	T	T	T	T	
	40	T	T	T	T	T	T	T	T	T	T	
	50		T	T	T	T	T	T	T	T	T	
	63			T	T	T	T	T	T	T	T	
80				T	T	T		T	T	T		
100					T	T			T	T		

# Selectivity tables with fuses

Upstream: Compact NSXm Micrologic, TM-D

Downstream: gG & aM fuses



Ue: 380-415 V AC

Upstream		Compact NSXm E/B/F/N/H									
Trip unit		TM-D									
Downstream	Rating (A)	16	25	32	40	50	63	80	100	125	160
	I <sub>r</sub> (A)	16	25	32	40	50	63	80	100	125	160
gG fuse	2	T	T	T	T	T	T	T	T	T	T
	4	T	T	T	T	T	T	T	T	T	T
	6	T	T	T	T	T	T	T	T	T	T
	10	T	T	T	T	T	T	T	T	T	T
	16				T	T	T	T	T	T	T
	20				T	T	T	T	T	T	T
	25				T	T	T	T	T	T	T
	32								T	T	T
	35									T	T
	40									T	T
	50									T	T
	63									T	T
	80										T

Upstream		Compact NSXm E/B/F/N/H															
Trip unit		Micrologic 4.1															
Downstream	Rating (A)	25				50					100				160		
		10	16	20	25	20	25	32	40	50	50	63	80	100	100	125	160
gG fuse	2	T	T	T	T	T	T	T	T	T	T	T	T	T	T	T	T
	4	T	T	T	T	T	T	T	T	T	T	T	T	T	T	T	T
	6		T	T	T	T	T	T	T	T	T	T	T	T	T	T	T
	10		0.2	0.2	0.3	0.2	0.3	0.3	0.4	0.5	T	T	T	T	T	T	T
	16								0.4	0.5	T	T	T	T	T	T	T
	20								0.4	0.5	T	T	T	T	T	T	T
	25								0.4	0.5	T	T	T	T	T	T	T
	32												T	T	T	T	T
	35													T	T	T	T
	40														T	T	T
	50														T	T	T
	63														T	T	T
	80														T	T	T

Upstream		Compact NSXm E/B/F/N/H									
Trip unit		TM-D									
Downstream	Rating (A)	16	25	32	40	50	63	80	100	125	160
	I <sub>r</sub> (A)	16	25	32	40	50	63	80	100	125	160
aM fuse	2	T	T	T	T	T	T	T	T	T	T
	4	T	T	T	T	T	T	T	T	T	T
	6	T	T	T	T	T	T	T	T	T	T
	10				T	T	T	T	T	T	T
	16						T	T	T	T	T
	20							T	T	T	T
	32								T	T	T
	40									T	T

Upstream		Compact NSXm E/B/F/N/H															
Trip unit		Micrologic 4.1															
Downstream	Rating (A)	25				50					100				160		
		10	16	20	25	20	25	32	40	50	50	63	80	100	100	125	160
aM fuse	2	T	T	T	T	T	T	T	T	T	T	T	T	T	T	T	T
	4		T	T	T	T	T	T	T	T	T	T	T	T	T	T	T
	6			0.2	0.3	0.2	0.3	0.3	0.4	0.5	T	T	T	T	T	T	T
	10							0.3	0.4	0.5	T	T	T	T	T	T	T
	16											T	T	T	T	T	T
	20												T	T	T	T	T
	32														T	T	T
	40															T	T



# Selectivity tables with fuses

Upstream: fuses NH000/NH00/NH0/NH1

Downstream: iC60N/H/L curve B, C, D

Ue: 380-415 V AC Ph/Ph  
(220-240 V AC Ph/N)

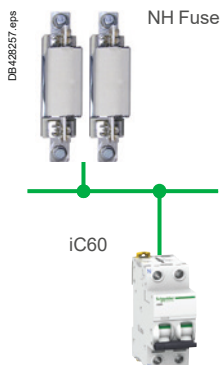

Upstream		NH000/NH00/NH0/NH1													
In (A)		16	20	25	32	35	40	50	63	80	100	125	160	200	250
<b>Downstream Rating (A)</b>															
		<b>Selectivity limit (kA)</b>													
iC60 Curve B	0.5	T	T	T	T	T	T	T	T	T	T	T	T	T	T
	1	1.6	4.5	T	T	T	T	T	T	T	T	T	T	T	T
	1.6	0.8	1.7	5	T	T	T	T	T	T	T	T	T	T	T
	2	0.65	1.2	2.7	5.1	7.5	15	T	T	T	T	T	T	T	T
	3		1	1.9	3.3	4.5	8	T	T	T	T	T	T	T	T
	4		0.75	1	2	2.7	4	7.5	9.5	T	T	T	T	T	T
	6			0.8	1.5	2	2.7	4.5	7.2	8.5	T	T	T	T	T
	10			0.6	1.1	1.5	1.9	2.9	5.4	5	12	13	T	T	T
	13			0.55	0.9	1.4	1.7	2.5	3.5	4.2	9.5	9.9	T	T	T
	16				0.8	1.2	1.5	2.2	3	3.6	7.8	8	T	T	T
	20					1	1.3	1.8	2.5	3.1	6	6.5	T	T	T
	25						1	1.7	2.2	2.8	5.4	5.7	15	T	T
	32							1.5	2	2.6	4.5	4.9	11.7	T	T
40								1.9	2.4	4	4.6	10.2	T	T	
50									2.3	3.7	4.4	9.7	T	T	
63										3.5	4.2	9	T	T	
iC60 Curve C	0.5	T	T	T	T	T	T	T	T	T	T	T	T	T	T
	1	1.6	4.5	T	T	T	T	T	T	T	T	T	T	T	T
	1.6	0.8	1.7	5	T	T	T	T	T	T	T	T	T	T	T
	2	0.65	1.2	2.7	5.1	7.5	15	T	T	T	T	T	T	T	T
	3		1	1.9	3.3	4.5	8	T	T	T	T	T	T	T	T
	4		0.75	1	2	2.7	4	7.5	9.5	T	T	T	T	T	T
	6			0.8	1.5	2	2.7	4.5	7.2	8.5	T	T	T	T	T
	10			0.6	1.1	1.5	1.9	2.9	5.4	5	12	13	T	T	T
	13			0.55	0.9	1.4	1.7	2.5	3.5	4.2	9.5	9.9	T	T	T
	16				0.8	1.2	1.5	2.2	3	3.6	7.8	8	T	T	T
	20					1	1.3	1.8	2.5	3.1	6	6.5	T	T	T
	25						1.7	2.2	2.8	2.8	5.4	5.7	15	T	T
	32							2	2.6	4.5	4.9	11.7	T	T	
40								2.4	4	4.6	10.2	T	T		
50									3.7	4.4	9.7	T	T		
63										4.2	9	T	T		
iC60 Curve D	0.5	T	T	T	T	T	T	T	T	T	T	T	T	T	T
	1	1.5	4.4	T	T	T	T	T	T	T	T	T	T	T	T
	1.6	0.7	1.7	4.9	T	T	T	T	T	T	T	T	T	T	T
	2	0.6	1.2	2.7	5	7.3	14.8	T	T	T	T	T	T	T	T
	3		0.9	1.9	3.3	4.5	8	T	T	T	T	T	T	T	T
	4		0.75	1	2	2.7	4	7.5	9.5	T	T	T	T	T	T
	6			0.8	1.5	2	2.7	4.5	7.2	8.5	T	T	T	T	T
	10			0.6	1.1	1.5	1.9	2.9	5.4	5	12	13	T	T	T
	13				0.9	1.4	1.7	2.5	3.5	4.2	9.5	9.9	T	T	T
	16				1.2	1.5	1.7	2.2	3	3.6	7.8	8	T	T	T
	20					1.3	1.8	2.5	3.1	6	6.5	T	T	T	
	25						1.7	2.2	2.8	5.4	5.7	15	T	T	
	32							2	2.6	4.5	4.9	11.7	T	T	
40								2.4	4	4.6	10.2	T	T		
50									3.7	4.4	9.7	T	T		
63										4.2	9	T	T		

1.7 Selectivity limit (kA) = 1.7 kA.

T Total selectivity.

No selectivity.

See also guide CA908036 for Acti9 and fuses coordination.

# Selectivity tables with fuses

Upstream: fuses NH000/NH00/NH0/NH1

Downstream: iDPN N, iDPN H

A

Ue: 380-415 V Ph/Ph  
(220-240 V Ph/N)

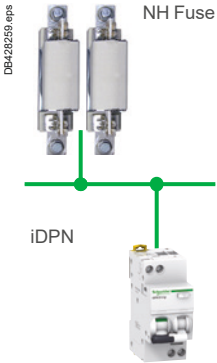

Upstream		NH000/NH00/NH0/NH1													
In (A)		16	20	25	32	35	40	50	63	80	100	125	160	200	250
<b>Downstream Rating (A)</b>															
		<b>Selectivity limit (kA)</b>													
iDPN N	1	2	T	T	T	T	T	T	T	T	T	T	T	T	T
iDPN H	2	0.5	0.8	2.5	T	T	T	T	T	T	T	T	T	T	T
1P+N	3		0.6	1.2	2.6	5	T	T	T	T	T	T	T	T	T
Curve B	4		0.5	1.05	2	4	5	T	T	T	T	T	T	T	T
	6			1	1.4	2.5	3.5	4.7	8.5	T	T	T	T	T	T
	10			0.75	1.1	2	2.5	3.1	3.6	5.4	T	T	T	T	T
	16			0.6	0.9	1.55	1.7	2.2	3	4.4	T	T	T	T	T
	20				0.8	1.4	1.6	2	2.45	3.5	T	T	T	T	T
	25					1.2	1.4	1.7	2.35	3.3	8	T	T	T	T
	32							1.5	2.3	3.2	7.5	T	T	T	T
	40									2.9	6.6	T	T	T	T
iDPN N	1	2	T	T	T	T	T	T	T	T	T	T	T	T	T
iDPN H	2	0.5	0.8	2.5	T	T	T	T	T	T	T	T	T	T	T
1P+N	3		0.6	1.2	2.6	5	T	T	T	T	T	T	T	T	T
Curve C	4		0.5	1.05	2	4	5	T	T	T	T	T	T	T	T
	6			0.9	1.4	2.5	3.5	4.65	8.5	T	T	T	T	T	T
	10			0.375	1.025	1.8	2.5	2.8	3.6	5.4	T	T	T	T	T
	16					0.775	1.7	2	3	4.4	T	T	T	T	T
	20						1.6	1.875	2.45	3.5	T	T	T	T	T
	25							0.85	2.35	3.3	8	T	T	T	T
	32								2.3	3.2	7.5	T	T	T	T
	40										6.6	T	T	T	T
iDPN N	1	2	T	T	T	T	T	T	T	T	T	T	T	T	T
iDPN H	2	0.5	0.8	2.5	T	T	T	T	T	T	T	T	T	T	T
1P+N	3		0.6	1.2	2.6	5	T	T	T	T	T	T	T	T	T
Curve D	4		0.5	1.05	2	4	5	T	T	T	T	T	T	T	T
	6			0.8	1.4	2.5	3.5	4.6	8.5	T	T	T	T	T	T
	10				0.95	1.6	2.5	2.5	3.6	5.4	T	T	T	T	T
	16						1.7	1.8	3	4.4	T	T	T	T	T
	20							1.75	2.45	3.5	T	T	T	T	T
	25								2.35	3.3	8	T	T	T	T
	32									3.2	7.5	T	T	T	T
	40										6.6	T	T	T	T

2.6 Selectivity limit (kA) = 2.6 kA.

T Total selectivity.

No selectivity.

See also guide CA908036 for Acti9 and fuses coordination.

# Selectivity tables with fuses

Upstream: fuses NH000/NH00/NH0/NH1

Downstream: C120N/H and NG125N/H/L curve B, C, D

Ue: 380-415 V Ph/Ph  
(220-240 V Ph/N)

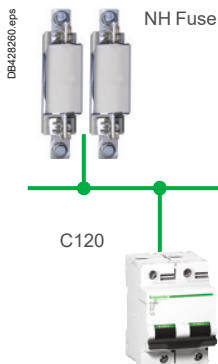

Upstream		NH000/NH00/NH0/NH1											
In (A)		25	32	35	40	50	63	80	100	125	160	200	250
Downstream Rating (A)		Selectivity limit (kA)											
C120 NG125 Curve B	10		0.75	0.95	1.1	1.6	1.9	2.7	5.5	7.5	18.5	T	T
	16		0.55	0.8	0.95	1.4	1.7	2.3	4.6	7	12.5	T	T
	20				0.9	1.35	1.65	2.2	4.5	6.5	12	22.5	T
	25					1.15	1.45	2.05	3.8	5.8	9.5	13.5	T
	32					1.1	1.4	2	3.7	5	9	13	T
	40						1.35	1.85	3.4	4.8	7.6	10.5	T
	50								3.25	4.7	7.2	9.5	T
	63								3	4.5	7	9.3	T
	80									4.2	6.2	8.2	T
	100											7.7	T
125											7.5	T	
C120 NG125 Curve C	10		0.75	0.95	1.1	1.6	1.9	2.7	5.5	7.5	18.5	T	T
	16		0.55	0.8	0.95	1.4	1.7	2.3	4.6	7	12.5	T	T
	20				0.9	1.35	1.65	2.2	4.5	6.5	12	22.5	T
	25					1.15	1.45	2.05	3.8	5.8	9.5	13.5	T
	32						1.4	2	3.7	5	9	13	T
	40							1.85	3.4	4.8	7.6	10.5	T
	50								3.25	4.7	7.2	9.5	T
	63									4.5	7	9.3	T
	80										7	8.2	T
	100											7.7	T
125												T	
C120 NG125 Curve D	10		0.75	0.95	1.1	1.6	1.9	2.7	5.5	7.5	18.5	T	T
	16				0.95	1.4	1.7	2.3	4.6	7	12.5	T	T
	20					1.35	1.65	2.2	4.5	6.5	12	22.5	T
	25						1.45	2.05	3.8	5.8	9.5	13.5	T
	32							2	3.7	5	9	13	T
	40								3.4	4.8	7.6	10.5	T
	50									4.7	7.2	9.5	T
	63										7	9.3	T
	80											8.2	T
	100												T
125												T	

1.4 Selectivity limit (kA) = 1.4 kA.

T Total selectivity.

No selectivity.

See also guide CA908036 for Acti9 and fuses coordination.



# Selectivity tables with fuses

Upstream: Fupact (gG fuse-link)

Downstream: Compact NSXm, NSX100 to 630

A

$U_e \leq 440 \text{ V AC}$

DB125662 eps

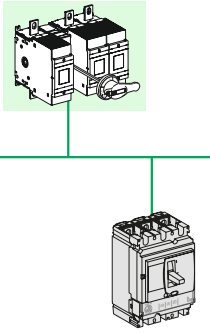

Upstream		gG fuse															
Downstream	Rating (A)	160	200	250	315	355	400	450	500	560	630	670	710	750	800	1000	1250
<b>Compact NSXm</b>	<b>16</b>	0.5	5	T	T	T	T	T	T	T	T	T	T	T	T	T	T
<b>E/B/F/N/H</b>	<b>25</b>	0.5	5	30	T	T	T	T	T	T	T	T	T	T	T	T	T
<b>TM-D</b>	<b>32</b>	0.5	5	20	T	T	T	T	T	T	T	T	T	T	T	T	T
	<b>40</b>	0.5	5	20	30	T	T	T	T	T	T	T	T	T	T	T	T
	<b>50</b>	0.5	5	15	30	T	T	T	T	T	T	T	T	T	T	T	T
	<b>63</b>	0.5	5	10	30	T	T	T	T	T	T	T	T	T	T	T	T
	<b>80</b>		5	10	25	T	T	T	T	T	T	T	T	T	T	T	T
	<b>100</b>			7	20	T	T	T	T	T	T	T	T	T	T	T	T
	<b>125</b>					T	T	T	T	T	T	T	T	T	T	T	T
	<b>160</b>					T	T	T	T	T	T	T	T	T	T	T	T
<b>Compact NSXm</b>	<b>25</b>	0.375	5	20	30	T	T	T	T	T	T	T	T	T	T	T	T
<b>E/B/F/N/H</b>	<b>50</b>	0.375	5	15	30	T	T	T	T	T	T	T	T	T	T	T	T
<b>Micrologic 4.1</b>	<b>100</b>			10	30	T	T	T	T	T	T	T	T	T	T	T	T
	<b>160</b>					T	T	T	T	T	T	T	T	T	T	T	T
<b>Compact NSX100</b>	<b>16</b>	2.5	4	7	15	T	T	T	T	T	T	T	T	T	T	T	T
<b>TM-D</b>	<b>25</b>	2.5	4	7	15	T	T	T	T	T	T	T	T	T	T	T	T
	<b>32</b>	2.5	4	7	15	T	T	T	T	T	T	T	T	T	T	T	T
	<b>40</b>	2.5	4	7	15	T	T	T	T	T	T	T	T	T	T	T	T
	<b>50</b>	2.5	4	7	15	T	T	T	T	T	T	T	T	T	T	T	T
	<b>63</b>	2.5	4	7	15	T	T	T	T	T	T	T	T	T	T	T	T
	<b>80</b>		4	7	15	T	T	T	T	T	T	T	T	T	T	T	T
	<b>100</b>			7	15	T	T	T	T	T	T	T	T	T	T	T	T
<b>Compact NSX160</b>	<b>≤ 63</b>			7	15	T	T	T	T	T	T	T	T	T	T	T	T
<b>TM-D</b>	<b>80</b>			7	15	T	T	T	T	T	T	T	T	T	T	T	T
	<b>100</b>					T	T	T	T	T	T	T	T	T	T	T	T
	<b>125</b>						T	T	T	T	T	T	T	T	T	T	T
	<b>160</b>						T	T	T	T	T	T	T	T	T	T	T
<b>Compact NSX250</b>	<b>≤ 100</b>						T	T	T	T	T	T	T	T	T	T	T
<b>TM-D</b>	<b>125</b>						T	T	T	T	T	T	T	T	T	T	T
	<b>160</b>						T	T	T	T	T	T	T	T	T	T	T
	<b>200</b>						T	T	T	T	T	T	T	T	T	T	T
	<b>250</b>						T	T	T	T	T	T	T	T	T	T	T
<b>Compact NSX100</b>	<b>40</b>			4	10	T	T	T	T	T	T	T	T	T	T	T	T
<b>Micrologic</b>	<b>100</b>			4	10	T	T	T	T	T	T	T	T	T	T	T	T
<b>Compact NSX160</b>	<b>40</b>				7	8	T	T	T	T	T	T	T	T	T	T	T
<b>Micrologic</b>	<b>100</b>				7	8	T	T	T	T	T	T	T	T	T	T	T
	<b>160</b>				7	8	T	T	T	T	T	T	T	T	T	T	T
<b>Compact NSX250</b>	<b>100</b>						10	T	T	T	T	T	T	T	T	T	T
<b>Micrologic</b>	<b>160</b>						10	T	T	T	T	T	T	T	T	T	T
	<b>250</b>							T	T	T	T	T	T	T	T	T	T
<b>Compact NSX400</b>	<b>160</b>							6	7	9	10	T	T	T	T	T	T
<b>Micrologic</b>	<b>200</b>							6	7	9	10	T	T	T	T	T	T
	<b>250</b>							6	7	9	10	T	T	T	T	T	T
	<b>320</b>							6	7	9	10	T	T	T	T	T	T
	<b>400</b>							6	7	9	10	T	T	T	T	T	T
<b>Compact NSX630</b>	<b>400</b>											12	15	30	T	T	T
<b>Micrologic</b>	<b>630</b>											12	15	30	T	T	T

- Selectivity limit in kA
- Total selectivity.
- No selectivity.



**IEC 60947-2, Annex A  
 IEC 60364-4-43 (2008) § 434.5.1**

**What is cascading?**

Cascading is the use of the current limiting capacity of circuit breakers at a given point to permit installation of lower-rated and therefore lower-cost circuit breakers downstream. Cascading is also called "Back-up" protection.

The upstream Compact circuit breakers acts as a barrier against short-circuit currents. In this way, downstream circuit breakers with lower breaking capacities than the prospective short-circuit (at their point of installation) operate under their normal breaking conditions.

Since the current is limited throughout the circuit controlled by the limiting circuit breaker, cascading applies to all switchgear downstream. It is not restricted to two consecutive devices.

**General use of cascading**

With cascading, the devices can be installed in different switchboards. Thus, in general, cascading refers to any combination of circuit breakers where a circuit breaker with a breaking capacity less than the prospective  $I_{sc}$  at its point of installation can be used. Of course, the breaking capacity of the upstream circuit breaker must be greater than or equal to the prospective short-circuit current at its point of installation.

The combination of two circuit breakers in cascading configuration is covered by the following standards of:

- design and manufacture of circuit breakers (IEC 60947-2, Annex A),
- electrical distribution networks (IEC 60364-4-43 Ed 3 2008 § 434.5.1).

**Coordination between circuit breakers**

The use of a protective device possessing a breaking capacity less than the prospective short-circuit current at its installation point is permitted as long as another device is installed upstream with at least the necessary breaking capacity. In this case, the characteristics of the two devices must be coordinated in such a way that the energy let through by the upstream device is not more than that which can be withstood by the downstream device and the cables protected by these devices without damage.

Cascading can only be checked by laboratory tests and the possible combinations can be specified only by the circuit breaker manufacturer.

**Cascading and protection selectivity**

In cascading configurations, due to the Roto-active breaking technique, selectivity is maintained and, in some cases, even enhanced. Consult the enhanced selectivity tables on page A-170 for data on selectivity limits.

**Cascading tables**

**Schneider Electric cascading tables are:**

- drawn up on the basis of calculations (comparison between the energy limited by the upstream device and the maximum permissible thermal stress for the downstream device)
- verified experimentally in accordance with IEC standard 60947-2.

For 50/60 Hz distribution systems with 220-240 V, 380-415 V and 440 V between phases, the tables of the following pages indicate cascading possibilities between upstream Compact and downstream Acti 9 and Compact circuit breakers as well as between upstream Masterpact and downstream Compact circuit breakers.

**Circuit breaker with Vigi module (Add-On Residual Current Device - RCD):**

When circuit breakers are equipped with Vigi module, the following cascading tables are still applicable.

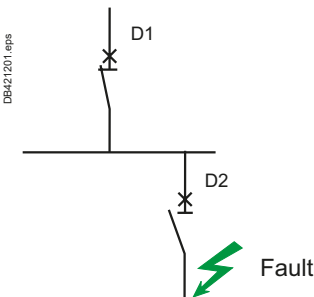
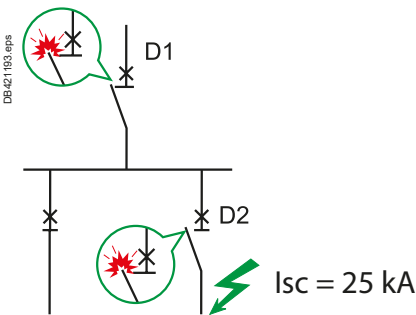

D1 and D2 in series.

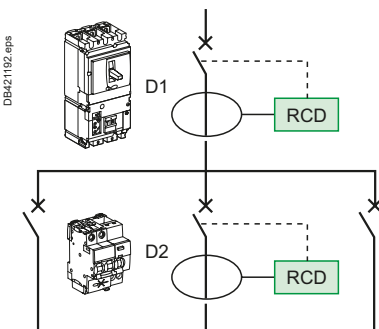

# Cascading



## Using the cascading tables

This table takes in account all types of faults: between phases, phase and neutral, phase and earth in all earthing systems. In IT the following cascading tables can not be used to evaluate performances in case of "double fault" between two different phases and earth in two different locations of the installation. Each breaker shall comply to IEC60947-2 Annex H to be used in such a system. Depending on the network and the type of downstream circuit breaker, the selection table below indicates which table should be consulted to find out the cascading value.

## Selection table

		Upstream network					
		DB123986 eps L1 ——— N ———	DB123988 eps L1 ——— L2 ——— L3 ——— N ———	DB123987 eps L1 ——— L2 ——— L3 ———			
Type of Downstream network	Type of Downstream protection device	Type of circuit breaker upstream device: 1P, 2P, 3P or 4P circuit breaker					
		Ph/N 110-130 V	Ph/N 220-240 V	Ph/N 110-130 V Ph/Ph 220-240 V	Ph/N 220-240 V Ph/Ph 380-415 V	Ph/Ph 220-240 V	Ph/Ph 380-415 V
DB124079 eps N L1	DB123981 eps 2P	See table Ue: 220-240 V	See table Ue: 380-415 V	See table Ue: 220-240 V	See table Ue: 380-415 V		
	DB124191 eps 1P DB123992 eps 1P + N	See table Ue: 220-240 V	See table Ue: 380-415 V	See table Ue: 220-240 V	See table Ue: 380-415 V		
DB124192 eps L1 L2	DB123991 eps 2P			See table Ue: 220-240 V	See table Ue: 380-415 V	See table Ue: 220-240 V	See table Ue: 380-415 V
DB124080 eps L1 L2 L3	DB123993 eps 3P			See table Ue: 220-240 V	See table Ue: 380-415 V	See table Ue: 220-240 V	See table Ue: 380-415 V
DB124081 eps NL1 L2 L3	DB123994 eps 4P			See table Ue: 220-240 V	See table Ue: 380-415 V		
	DB123993 eps 3P DB123995 eps 3P+N			See table Ue: 220-240 V	See table Ue: 380-415 V		

[1] For fault phase-neutral with upstream protection of neutral, please consult the table Ue: 220-240 V.  
 [2] For iC60 1P+N circuit breaker connected between phase and neutral under 220-240 V, consult the table Ue: 220-240 V (only for faults between phase and neutral).

# Cascading

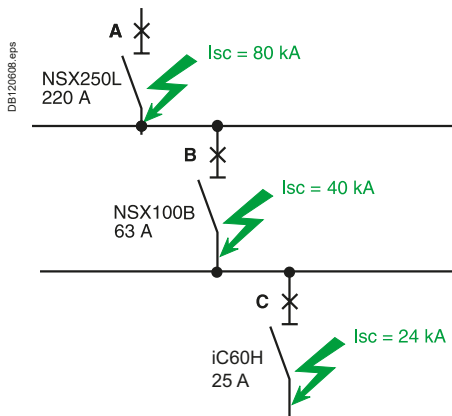

## Example of three level cascading

Consider three circuit breakers A, B and C connected in series. The criteria for cascading are fulfilled in the following two cases:

- the upstream device A is coordinated for cascading with both devices B and C (even if the cascading criteria are not fulfilled between B and C). It is simply necessary to check that the combinations A + B and A + C have the required breaking capacity

- each pair of successive devices is coordinated, i.e. A with B and B with C (even if the cascading criteria are not fulfilled between A and C). It is simply necessary to check that the combinations A + B and B + C have the required breaking capacity. The upstream breaker A is a NSX250L (breaking capacity 150 kA) for a prospective  $I_{sc}$  of 80 kA across its output terminals.

A NSX100B (breaking capacity 25 kA) can be used for circuit breaker B for a prospective  $I_{sc}$  of 40 kA across its output terminals, since the "reinforced" breaking capacity provided by cascading with the upstream NSX250L is 50 kA.

A iC60H (breaking capacity 15 kA) can be used for circuit breaker C for a prospective  $I_{sc}$  of 24 kA across its output terminals since the "reinforced" breaking capacity provided by cascading with the upstream NSX250L is 25 kA.

Note that the "reinforced" breaking capacity of the iC60H with the NSX100B upstream is only 20 kA, but:

- A + B = 50 kA
- A + C = 25 kA.



## Cascading tables

## Contents

A

Downstream	Upstream							
Type	iDPN, iC40	iC60	C120	NG125	Compact NSXm	Compact NSX100	Compact NSX160	Compact NSX250
<b>380-415 V (Ph/N 220-240 V)</b>								
iDPN, iC40	page A-158	page A-158	page A-158	page A-158	page A-158	page A-158	page A-159	page A-159
iC60	-	page A-158	page A-158	page A-158	page A-158	page A-158	page A-159	page A-159
C120	-	-	page A-158	page A-158	page A-158	page A-158	page A-159	page A-159
NG125	-	-	-	page A-158	page A-158	page A-158	page A-159	page A-159
Compact NSXm	-	-	-	-	page A-158	page A-158	page A-159	page A-159
Compact NSX100	-	-	-	-	-	page A-158	page A-159	page A-159
Compact NSX160	-	-	-	-	-	-	page A-159	page A-159
Compact NSX250	-	-	-	-	-	-	-	page A-159
<b>440 V</b>								
iC60	-	page A-162	-	page A-162	page A-162	page A-162	page A-163	-
NG125	-	-	-	page A-162	page A-162	page A-162	page A-163	page A-163
Compact NSXm	-	-	-	-	page A-162	page A-162	page A-163	page A-163
Compact NSX100	-	-	-	-	-	page A-162	page A-163	page A-163
Compact NSX160	-	-	-	-	-	-	page A-163	page A-163
Compact NSX250	-	-	-	-	-	-	-	page A-163
<b>220-240 V (Ph/N 110-130 V)</b>								
iDPN	-	page A-166	page A-166	page A-166	page A-166	page A-166	page A-167	page A-167
iC60	-	page A-166	page A-166	page A-166	page A-166	page A-166	page A-167	page A-167
C120	-	-	page A-166	page A-166	page A-166	page A-166	page A-167	page A-167
NG125	-	-	-	page A-166	page A-166	page A-166	page A-167	page A-167
Compact NSXm	-	-	-	-	page A-166	page A-166	page A-167	page A-167
Compact NSX100	-	-	-	-	-	page A-166	page A-167	page A-167
Compact NSX160	-	-	-	-	-	-	page A-167	page A-167
Compact NSX250	-	-	-	-	-	-	-	page A-167

## Selectivity enhanced by cascading

Downstream	Upstream			
Type	Compact NSXm	Compact NSX100	Compact NSX160	Compact NSX250
<b>380-415 V (Ph/N 220-240 V)</b>				
iC60	page A-171	page A-171	pageA-173-A-174	pageA-173-A-174
C120	-	-	-	pageA-173-A-174
NG125	-	-	-	pageA-173-A-174
Compact NSXm	-	-	-	pageA-173-A-174
Compact NSX100	-	-	-	pageA-173-A-174
<b>440 V</b>				
Compact NSXm	-	-	-	pageA-179-A-180
iC60	page A-177	page A-177	pageA-179-A-180	-
NG125	-	-	pageA-179-A-180	pageA-179-A-180
Compact NSX100	-	-	-	pageA-179-A-180
<b>220-240 V (Ph/N 110-130 V)</b>				
iC60	-	page A-184	pageA-183-A-184	pageA-183-A-184
C120	-	-	-	pageA-183-A-184
NG125	-	-	page A-183	pageA-183-A-184
Compact NSXm	-	-	-	pageA-185-A-186
Compact NSX100	-	-	-	pageA-185-A-186



## Cascading tables

## Contents

Downstream	Upstream				
Type	Compact NSX400	Compact NSX630	Compact NS630b	Compact NS800 to 3200 H/L	Masterpact MTZ
<b>380-415 V (Ph/N 220-240 V)</b>					
Compact NSXm	page A-160	page A-160	page A-161	-	-
Compact NSX100	page A-160	page A-160	page A-161	page A-161	page A-161
Compact NSX160	page A-160	page A-160	page A-161	page A-161	page A-161
Compact NSX250	page A-160	page A-160	page A-161	page A-161	page A-161
Compact NSX400	page A-160	page A-160	page A-161	page A-161	page A-161
Compact NSX630	-	page A-160	page A-161	page A-161	page A-161
Compact NS630b	-	-	page A-161	page A-161	page A-161
Compact NS800	-	-	page A-161	page A-161	page A-161
Compact NS1000	-	-	page A-161	page A-161	page A-161
Compact NS1250	-	-	page A-161	page A-161	page A-161
Compact NS1600	-	-	page A-161	page A-161	page A-161
<b>440 V</b>					
Compact NSXm	page A-164	page A-164	-	-	-
Compact NSX100	page A-164	page A-164	page A-165	page A-165	page A-165
Compact NSX160	page A-164	page A-164	page A-165	page A-165	page A-165
Compact NSX250	page A-164	page A-164	page A-165	page A-165	page A-165
Compact NSX400	page A-164	page A-164	page A-165	page A-165	page A-165
Compact NSX630	-	page A-164	page A-165	page A-165	page A-165
Compact NS630b	-	-	page A-165	page A-165	page A-165
Compact NS800	-	-	page A-165	page A-165	page A-165
Compact NS1000	-	-	page A-165	page A-165	page A-165
Compact NS1250	-	-	page A-165	page A-165	page A-165
Compact NS1600	-	-	page A-165	page A-165	page A-165
<b>220-240 V (Ph/N 110-130 V)</b>					
Compact NSXm	page A-168	page A-168	-	-	-
Compact NSX100	page A-168	page A-168	page A-169	page A-169	page A-169
Compact NSX160	page A-168	page A-168	page A-169	page A-169	page A-169
Compact NSX250	page A-168	page A-168	page A-169	page A-169	page A-169
Compact NSX400	page A-168	page A-168	page A-169	page A-169	page A-169
Compact NSX630	-	page A-168	page A-169	page A-169	page A-169
Compact NSX630b	-	-	page A-169	page A-169	page A-169

## Selectivity enhanced by cascading

Downstream	Upstream					
Type	Compact NSX400	Compact NSX630	Compact NS800	Compact NS1000	Compact NS1250	Compact NS1600
<b>380-415 V (Ph/N 220-240 V)</b>						
Compact NSXm	page A-175	page A-175	-	-	-	-
Compact NSX100	page A-175	page A-175	page A-176	page A-176	page A-176	page A-176
Compact NSX160	page A-175	page A-175	page A-176	page A-176	page A-176	page A-176
Compact NSX250	-	page A-175	page A-176	page A-176	page A-176	page A-176
Compact NSX400	-	-	page A-176	page A-176	page A-176	page A-176
Compact NSX630	-	-	page A-176	page A-176	page A-176	page A-176
<b>440 V</b>						
Compact NSXm	page A-181	page A-181	-	-	-	-
Compact NSX100	page A-181	page A-181	page A-182	page A-182	page A-182	page A-182
Compact NSX160	page A-181	page A-181	page A-182	page A-182	page A-182	page A-182
Compact NSX250	page A-181	page A-181	page A-182	page A-182	page A-182	page A-182
Compact NSX400	-	-	page A-182	page A-182	page A-182	page A-182
Compact NSX630	-	-	page A-182	page A-182	page A-182	page A-182
<b>220-240 V (Ph/N 110-130 V)</b>						
Compact NSXm	page A-186	page A-186	-	-	-	-
Compact NSX100	page A-186	page A-186	page A-186	page A-186	-	-
Compact NSX160	page A-186	page A-186	page A-186	page A-186	-	-
Compact NSX250	-	page A-186	page A-186	page A-186	-	-
Compact NSX400	-	page A-186	page A-186	page A-186	-	-
Compact NSX630	-	-	-	page A-186	-	-

# Cascading

Upstream: iDPN, iC40, iC60, C120, NG125, Compact NSXm, NSX100

Downstream: iDPN, iC40, iC60, C120, NG125, Compact NSXm, NSX100

Ue: 380-415 V AC  
(Ph/N 220-240 V AC)

Upstream CB	iDPN N	iC40 N	iC60 N	H	L			iC120 N	H	NG125		
					≤ 25 A	32/40 A	50/63 A			N	H	L
Icu (kA)	10	10	10	15	25	20	15	10	15	25	36	50

Downstream CB														
	Rating (A)	Icu (kA)	Reinforced breaking capacity (kA)											
iDPN <sup>[1]</sup>	1-16	6	10	10	10	10	20	15	10	10	10	10	16	20
	25-40	6	10	10	10	10	15	10	10	10	10	10	16	20
iDPN N <sup>[1]</sup>	1-16	10					15	25	20	15		15	20	25
	25-40	10					15	20	15	15		15	20	25
iC40 <sup>[1]</sup>	2-16	4500/6	10	10	10	20	15	10	10	10	10	10	16	20
	20-40	4500/6	10	10	10	15	10	10	10	10	10	10	16	16
iCV40N <sup>[1]</sup>	6-16	6000	10	10	10	20	15	10	10	10	10	10	16	20
	20-40	6000	10	10	10	15	10	10	10	10	10	10	16	16
iC40N <sup>[1]</sup>	2-16	6000/10			15	25	20	15		15	16	20	20	25
	20-40	6000/10			15	20	15	15		15	16	16	16	20
iCV40H <sup>[1]</sup>	6-16	10000			15	25	20	15		15	16	20	20	25
	20-32	10000			15	20	15	15		15	16	16	16	20
iC60N	0.5-25	10				15	25	20	15		15	25	25	25
	32-40	10				15		20	15		15	25	25	25
	50-63	10				15		15			15	25	25	25
iC60H	0.5-25	15					25	20				25	36	36
	32-40	15						20				25	36	36
	50-63	15										25	36	36
iC60L	0.5-25	25											36	50
	32-40	20										25	36	50
	50-63	15										25	36	36
C120N	63-125	10								15	25	25	36	
C120H	63-125	15									25	25	36	
NG125N	1-125	25										36	36	
NG125H	1-125	36											50	

Upstream CB	NSXm					NSX100					
	E	B	F	N	H	B	F	N	H	S	L
Icu (kA)	16	25	36	50	70	25	36	50	70	100	150

Downstream CB												
	Rating (A)	Icu (kA)	Reinforced breaking capacity (kA)									
iDPN <sup>[1]</sup>	1-40	6	10	10	10	10	10	10	10	10	10	10
iDPNN <sup>[1]</sup>	1-16	10	16	20	20	20	20	20	20	20	20	20
	25-40	10	16	16	16	16	16	16	16	16	16	16
iC40 <sup>[1]</sup>	2-40	4500/6	10	10	10	10	10	10	10	10	10	10
iCV40N <sup>[1]</sup>	6-40	6000	10	10	10	10	10	10	10	10	10	10
iC40N <sup>[1]</sup>	2-16	6000/10	16	20	20	20	20	20	20	20	20	20
	20-40	6000/10	16	16	16	16	16	16	16	16	16	16
iCV40H <sup>[1]</sup>	6-16	10000	16	20	20	20	20	20	20	20	20	20
	20-32	10000	16	16	16	16	16	16	16	16	16	16
iC60N	0.5-40	10	16	20	25	30	30	20	25	30	30	30
	50-63	10	16	20	25	30	30	20	25	30	30	30
iC60H	0.5-40	15	16	25	36	36	36	25	36	40	40	40
	50-63	15	16	25	36	36	36	25	36	40	40	40
iC60L	0.5-25	25			36	36	36		36	40	40	40
	32-40	20		25	36	36	36	25	36	40	40	40
	50-63	15	16	25	36	36	36	25	36	40	40	40
C120N	63-125	10	16	25	25	25	25	25	25	25	25	25
C120H	63-125	15	16	25	25	25	25	25	25	25	25	25
NG125N	1-125	25			36	36	36		36	36	50	70
NG125H	1-125	36				40	50			40	50	100
NG125L	1-80	50					70				70	150
NSXm E	16-160	16		25	30	30	30	25	25	30	30	30
NSXm B	16-160	25			36	36	50		36	36	50	50
NSXm F	16-160	36				50	70			50	70	70
NSXm N	16-160	50					70				70	70
NSXm H	16-160	70									70	70
NSX100B	16-100	25							36	36	50	50
NSX100F	16-100	36								50	70	100
NSX100N	16-100	50									70	100
NSX100H	16-100	70										100
NSX100S	16-100	100										150

[1] 230 V phase to neutral

# Cascading table

Upstream: Compact NSX160, NSX250

Downstream: iDPN, iC40, iC60, C120, NG125, Compact NSXm, NSX100, NSX160, NSX250

Ue: 380-415 V AC  
(Ph/N 220-240 V AC)

A

Upstream CB	NSX160						NSX250					
	B	F	N	H	S	L	B	F	N	H	S	L
Icu (kA)	25	36	50	70	100	150	25	36	50	70	100	150

Downstream CB														
	Rating (A)	Icu (kA)	Reinforced breaking capacity (kA)											
iDPN <sup>[1]</sup>	1-40	6	10	10	10	10	10	10	10	10	10	10	10	10
iDPN N <sup>[1]</sup>	1-16	10	20	20	20	20	20	20	20	20	20	20	20	20
	25-40	10	16	16	16	16	16	16	16	16	16	16	16	16
iC40 <sup>[1]</sup>	2-40	4500/6	10	10	10	10	10	10	10	10	10	10	10	10
iCV40N <sup>[1]</sup>	6-40	6000	10	10	10	10	10	10	10	10	10	10	10	10
iC40N <sup>[1]</sup>	2-16	6000/10	20	20	20	20	20	20	20	20	20	20	20	20
	20-40	6000/10	16	16	16	16	16	16	16	16	16	16	16	16
iCV40H <sup>[1]</sup>	6-16	10000	20	20	20	20	20	20	20	20	20	20	20	20
	20-32	10000	16	16	16	16	16	16	16	16	16	16	16	16
iC60N	0.5-40	10	20	25	30	30	30	30	20	25	30	30	30	30
	50-63	10	20	25	30	30	30	30	20	25	25	25	25	25
iC60H	0.5-40	15	25	36	40	40	40	40	25	30	30	30	30	30
	50-63	15	25	36	36	36	36	36	25	25	25	25	25	25
iC60L	0.5-25	25	25	36	40	40	40	40	25	30	30	30	30	30
	32-40	20	25	36	40	40	40	40	25	30	30	30	30	30
	50-63	15	25	36	36	36	36	36	25	25	25	25	25	25
C120N	63-125	10	25	25	25	25	25	25	25	25	25	25	25	25
C120H	63-125	15	25	25	25	25	25	25	25	25	25	25	25	25
NG125N	1-125	25		36	36	36	50	70		36	36	36	50	70
NG125H	1-125	36			40	50	70	100			40	50	70	100
NG125L	1-80	50			50	70	100	150			50	70	100	150
NSXm E	16-160	16	25	25	30	30	30	30	25	25	30	30	30	30
NSXm B	16-160	25		36	36	50	50	50		36	36	50	50	50
NSXm F	16-160	36			50	70	70	70			50	70	70	70
NSXm N	16-160	50				70	70	70				70	70	70
NSXm H	16-160	70												
NSX100B	16-100	25		36	36	50	50	50		36	36	50	50	50
NSX100F	16-100	36			50	70	100	150			50	70	100	150
NSX100N	16-100	50				70	100	150				70	100	150
NSX100H	16-100	70					100	150					100	150
NSX100S	16-100	100						150						150
NSX100L	16-100	150												
NSX160B	16-160	25		36	36	50	50	50		36	36	50	50	50
NSX160F	16-160	36			50	70	100	150			50	70	100	150
NSX160N	16-160	50				70	100	150				70	100	150
NSX160H	16-160	70					100	150					100	150
NSX160S	16-160	100						150						150
NSX160L	16-160	150												
NSX250B	16-250	25								36	36	50	50	50
NSX250F	16-250	36									50	70	100	150
NSX250N	16-250	50										70	100	150
NSX250H	16-250	70											100	150
NSX250S	16-250	100												150
NSX250L	16-250	150												

[1] 230 V phase to neutral

# Cascading

Upstream: Compact NSX400, NSX630

Downstream: Compact NSXm, NSX100, NSX160, NSX250, NSX400, NSX630

A

Ue: 380-415 V AC  
(Ph/N 220-240 V AC)

Upstream CB	NSX400					NSX630				
	F	N	H	S	L	F	N	H	S	L
Icu (kA)	36	50	70	100	150	36	50	70	100	150

Downstream CB												
	Rating (A)	Icu (kA)	Reinforced breaking capacity (kA)									
NSXm E	16-160	16	25	30	30	30	30	25	30	30	30	30
NSXm B	16-160	25	36	36	50	50	50	36	36	50	50	50
NSXm F	16-160	36		50	70	70	70		50	70	70	70
NSXm N	16-160	50			70	70	70			70	70	70
NSXm H	16-160	70										
NSX100B	16-100	25	36	36	50	50	50	36	36	50	50	50
NSX100F	16-100	36		50	70	100	150		50	70	100	150
NSX100N	16-100	50			70	100	150			70	100	150
NSX100H	16-100	70				100	150				100	150
NSX100S	16-100	100					150					150
NSX100L	16-100	150										
NSX160B	16-160	25	36	36	50	50	50	36	36	50	50	50
NSX160F	16-160	36		50	70	100	150		50	70	100	150
NSX160N	16-160	50			70	100	150			70	100	150
NSX160H	16-160	70				100	150				100	150
NSX160S	16-160	100					150					150
NSX160L	16-160	150										
NSX250B	16-250	25	36	36	50	50	50	36	36	50	50	50
NSX250F	16-250	36		50	70	100	150		50	70	100	150
NSX250N	16-250	50			70	100	150			70	100	150
NSX250H	16-250	70				100	150				100	150
NSX250S	16-250	100					150					150
NSX250L	16-250	150										
NSX400F	250-400	36		50	70	100	150		50	70	100	150
NSX400N	250-400	50			70	100	150			70	100	150
NSX400H	250-400	70				100	150				100	150
NSX400S	250-400	100					150					150
NSX400L	250-400	150										
NSX630F	250-630	36							50	70	100	150
NSX630N	250-630	50								70	100	150
NSX630H	250-630	70									100	150
NSX630S	250-630	100										150
NSX630L	250-630	150										

# Cascading

Upstream: Compact NS630b-1600, Compact NS1600-3200, Masterpact MTZ

Downstream: Compact NSX, Compact NS630b-1600

Ue: 380-415 V AC  
(Ph/N 220-240 V AC)

A

Upstream CB	NS630b-1600				NS1600-3200		MTZ1	MTZ2
	N	H	L <sup>[1]</sup>	LB <sup>[2]</sup>	N	H	L1	L1
Icu (kA)	50	70	150	200	70	85	150	150

Downstream CB											
	Rating (A)	Icu (kA)	Reinforced breaking capacity (kA)								
NSX100B	16-100	25	50	50	50	50			50		
NSX100F	16-100	36	50	70	150	150			150		
NSX100N	16-100	50		70	150	150			150		
NSX100H	16-100	70			150	150			150		
NSX100S	16-100	100			150	200			150		
NSX100L	16-100	150				200					
NSX160B	16-160	25	50	50	50	50			50		
NSX160F	16-160	36	50	70	150	150			150		
NSX160N	16-160	50		70	150	150			150		
NSX160H	16-160	70			150	150			150		
NSX160S	16-160	100			150	200			150		
NSX160L	16-160	150				200					
NSX250B	16-250	25	50	50	50	50			50		
NSX250F	16-250	36	50	70	150	150			150		
NSX250N	16-250	50		70	150	150			150		
NSX250H	16-250	70			150	150			150		
NSX250S	16-250	100			150	200			150		
NSX250L	16-250	150				200					
NSX400F	250-400	36	50	70	150	150			150		
NSX400N	250-400	50		70	150	150			150		
NSX400H	250-400	70			150	150			150		
NSX400S	250-400	100			150	200			150		
NSX400L	250-400	150				200					
NSX630F	250-630	36	50	70	150	150			150		
NSX630N	250-630	50		70	150	150			150		
NSX630H	250-630	70			150	150			150		
NSX630S	250-630	100			150	200			150		
NSX630L	250-630	150				200					
NS630b-1600N	630-1600	50		70	150	200	70	70	150	65	
NS630b-1600H	630-1600	70			150	200			150		

[1] Compact NS630bL, NS800L, NS1000L

[2] Compact NS630bLB, NS800LB

# Cascading

Upstream: iC60, NG125, Compact NSXm, NSX100

Downstream: iC60, NG125, Compact NSXm, NSX100

A

Ue: 440 V AC

Upstream CB	iC60					NG125		
	N	H	L			N	H	L
			≤ 25 A	32-40 A	50-63 A			
Icu (kA)	6	10	20	15	10	20	30	40

Downstream CB										
	Rating (A)	Icu (kA)	Reinforced breaking capacity (kA)							
iC60N	0.5-63	6		10	20	15	10	20	20	20
iC60H	0.5-63	10			20	15		20	25	25
iC60L	0.5-25	20							30	40
	32-40	15						20	30	30
	50-63	10						20	25	25
NG125N	1-125	20							30	40
NG125H	1-125	30								40

Upstream CB	NSXm					NSX100					
	E	B	F	N	H	B	F	N	H	S	L
Icu (kA)	15	20	35	50	65	20	35	50	65	90	130

Downstream CB													
	Rating (A)	Icu (kA)	Reinforced breaking capacity (kA)										
iC60N	0.5-63	6	10	15	15	20	20	15	15	20	20	20	20
iC60H	0.5-63	10		20	20	25	25	20	20	25	25	25	25
iC60L	0.5-25	20				25	25			25	25	25	25
	32-40	15		20	20	25	25	20	20	25	25	25	25
	50-63	10		20	20	25	25	20	20	25	25	25	25
NG125N	1-125	20			35	35	35		35	35	35	50	65
NG125H	1-125	30			35	40	50		35	40	50	65	90
NG125L	1-80	40				50	65			50	65	90	130
NSXm E	16-160	15		20	30	30	30	20	20	30	30	30	30
NSXm B	16-160	20			35	35	50		35	35	50	50	50
NSXm F	16-160	35				50	65			50	65	65	65
NSXm N	16-160	50					65				65	65	65
NSXm H	16-160	65											
NSX100B	16-100	20							35	35	50	50	50
NSX100F	16-100	35								50	65	90	130
NSX100N	16-100	50									65	90	130
NSX100H	16-100	65										90	130
NSX100S	16-100	90											130

# Cascading

Upstream: Compact NSX160, NSX250

Downstream: iC60, NG125, Compact NSXm, NSX100, NSX160, NSX250

Ue: 440 V AC



Upstream CB	NSX160						NSX250					
	B	F	N	H	S	L	B	F	N	H	S	L
Icu (kA)	20	35	50	65	90	130	20	35	50	65	90	130

Downstream CB														
	Rating (A)	Icu (kA)	Reinforced breaking capacity (kA)											
iC60N	0.5-63	6	15	15	20	20	20	20						
iC60H	0.5-63	10	20	20	25	25	25	25						
iC60L	0.5-25	20			25	25	25	25						
	32-40	15	20	20	25	25	25	25						
	50-63	10	20	20	25	25	25	25						
NG125N	1-125	20		35	35	35	50	65		35	35	35	50	65
NG125H	1-125	30		35	40	50	65	90		35	40	50	65	90
NG125L	1-80	40			50	65	90	130			50	65	90	130
NSXm E	16-160	15	20	20	30	30	30	30	20	20	30	30	30	30
NSXm B	16-160	20		35	35	50	50	50		35	35	50	50	50
NSXm F	16-160	35			50	65	65	65			50	65	65	65
NSXm N	16-160	50				65	65	65				65	65	65
NSXm H	16-160	65												
NSX100B	16-100	20		35	35	50	50	50		35	35	50	50	50
NSX100F	16-100	35			50	65	90	130			50	65	90	130
NSX100N	16-100	50				65	90	130				65	90	130
NSX100H	16-100	65					90	130					90	130
NSX100S	16-100	90						130						130
NSX100L	16-100	130												
NSX160B	16-160	20		35	35	50	50	50		35	35	50	50	50
NSX160F	16-160	35			50	65	90	130			50	65	90	130
NSX160N	16-160	50				65	90	130				65	90	130
NSX160H	16-160	65					90	130					90	130
NSX160S	16-160	90						130						130
NSX160L	16-160	130												
NSX250B	16-250	20								35	35	50	50	50
NSX250F	16-250	35									50	65	90	130
NSX250N	16-250	50										65	90	130
NSX250H	16-250	65											90	130
NSX250S	16-250	90												130
NSX250L	16-250	130												

# Cascading

Upstream: Compact NSX400, NSX630

Downstream: Compact NSXm, NSX100, NSX160, NSX250, NSX400, NSX630

Ue: 440 V AC

A

Upstream CB	NSX400					NSX630				
	F	N	H	S	L	F	N	H	S	L
Icu (kA)	30	42	65	90	130	30	42	65	90	130

Downstream CB												
	Rating (A)	Icu (kA)	Reinforced breaking capacity (kA)									
NSXm E	16-160	10	20	30	30	30	30	20	30	30	30	30
NSXm B	16-160	20	30	30	50	50	50	30	30	50	50	50
NSXm F	16-160	35		42	65	65	65		42	65	65	65
NSXm N	16-160	50			65	65	65			65	65	65
NSXm H	16-160	65										
NSX100B	16-100	20	30	30	50	50	50	30	30	50	50	50
NSX100F	16-100	35		42	65	90	130		42	65	90	130
NSX100N	16-100	50			65	90	130			65	90	130
NSX100H	16-100	65				90	130				90	130
NSX100S	16-100	90					130					130
NSX100L	16-100	130										
NSX160B	16-160	20	30	30	50	50	50	30	30	50	50	50
NSX160F	16-160	35		42	65	90	130		42	65	90	130
NSX160N	16-160	50			65	90	130			65	90	130
NSX160H	16-160	65				90	130				90	130
NSX160S	16-160	90					130					130
NSX160L	16-160	130										
NSX250B	16-250	20	30	30	50	50	50	30	30	50	50	50
NSX250F	16-250	35		42	65	90	130		42	65	90	130
NSX250N	16-250	50			65	90	130			65	90	130
NSX250H	16-250	65				90	130				90	130
NSX250S	16-250	90					130					130
NSX250L	16-250	130										
NSX400F	250-400	30		42	65	90	130		42	65	90	130
NSX400N	250-400	42			65	90	130			65	90	130
NSX400H	250-400	65				90	130				90	130
NSX400S	250-400	90					130					130
NSX400L	250-400	130										
NSX630F	250-630	30							42	65	90	130
NSX630N	250-630	42								65	90	130
NSX630H	250-630	65									90	130
NSX630S	250-630	90										130
NSX630L	250-630	130										



# Cascading

Upstream: Compact NS630b-1600, Compact NS1600-3200, Masterpact MTZ

Downstream: Compact NSX, Compact NS630b-1600

U<sub>e</sub>: 440 V AC

A

Upstream CB	NS630b-1600				NS1600-3200		MTZ1	MTZ2
	N	H	L <sup>[1]</sup>	LB <sup>[2]</sup>	N	H	L1	L1
I <sub>cu</sub> (kA)	50	65	130	200	65	85	130	150

Downstream CB											
	Rating (A)	I <sub>cu</sub> (kA)	Reinforced breaking capacity (kA)								
NSX100B	16-100	20	50	50	50	50			50		
NSX100F	16-100	35	50	65	130	130			130		
NSX100N	16-100	50		65	130	130			130		
NSX100H	16-100	65			130	130			130		
NSX100S	16-100	90			130	200			130		
NSX100L	16-100	130				200					
NSX160B	16-160	20	50	50	50	50			50		
NSX160F	16-160	35	50	65	130	130			130		
NSX160N	16-160	50		65	130	130			130		
NSX160H	16-160	65			130	130			130		
NSX160S	16-160	90			130	200			130		
NSX160L	16-160	130				200					
NSX250B	16-250	20	50	50	50	50			50		
NSX250F	16-250	35	50	65	130	130			130		
NSX250N	16-250	50		65	130	130			130		
NSX250H	16-250	65			130	130			130		
NSX250S	16-250	90			130	200			130		
NSX250L	16-250	130				200					
NSX400F	250-400	30	50	65	130	130			130		
NSX400N	250-400	42		65	130	130			130		
NSX400H	250-400	65			130	130			130		
NSX400S	250-400	90			130	200			130		
NSX400L	250-400	130				200					
NSX630F	250-630	30	50	65	130	130			130		
NSX630N	250-630	42		65	130	130			130		
NSX630H	250-630	65			130	130			130		
NSX630S	250-630	90			130	200			130		
NSX630L	250-630	130				200					
NS630b-1600N	630-1600	50		65	130	200	65	65	130	65	
NS630b-1600H	630-1600	65			130	200			130		

[1] Compact NS630bL, NS800L, NS1000L

[2] Compact NS630bLB, NS800LB

# Cascading

Upstream: iC60, C120, NG125, Compact NSXm, NSX100

Downstream: iDPN, iC60, C120, NG125, Compact NSXm, NSX100

A

Ue: 220-240 V AC  
(Ph/N 110-130 V AC)

Upstream CB	iC60					C120		NG125		
	N	H	L			N	H	N	H	L
Icu (kA)	20	30	50	36	30	20	30	50	70	100

Downstream CB												
	Rating (A)	Icu (kA)	Reinforced breaking capacity (kA)									
iDPN	1-40	10	15	20	30	25	20	15	20	20	40	50
iDPN N	1-40	15	20	30	50	36	30	20	30	30	40	50
iC60N	0.5-25	20		30	50	36	30		30	50	50	50
	32-40	20		30		36	30		30	50	50	50
iC60H	50-63	20		30			30		30	50	50	50
	0.5-25	30			50	36				50	70	70
	32-40	30				36				50	70	70
	50-63	30								50	70	70
iC60L	0.5-25	50									70	100
	32-40	36								50	70	100
	50-63	30								50	70	100
C120N	63-125	20						30	50	70	70	
C120H	63-125	30							50	70	70	
NG125N	1-125	50								70	70	
NG125H	1-125	70									100	

Upstream CB	NSXm					NSX100					
	E	B	F	N	H	B	F	N	H	S	L
Icu (kA)	25	50	85	90	100	40	85	90	100	120	150

Downstream CB												
	Rating (A)	Icu (kA)	Reinforced breaking capacity (kA)									
iDPN	1-40	10	20	20	20	20	20	20	20	20	20	20
iDPN N	1-40	15	30	30	30	30	30	30	30	30	30	30
iC60N	0.5-63	20	25	40	60	60	60	40	40	60	60	60
iC60H	0.5-63	30		50	80	80	80	40	50	80	80	80
	0.5-25	50			80	80	80		65	80	80	80
iC60L	32-40	36		50	80	80	80	40	65	80	80	80
	50-63	30		50	80	80	80	40	65	80	80	80
	63-125	20	25	50	50	50	50	40	40	50	50	70
C120H	63-125	30		50	50	50	50	40	40	50	70	70
NG125N	1-125	50			60	70	70		60	70	70	85
NG125H	1-125	70			85	85	85		85	85	85	85
NG125L	1-80	100										
NSXm E	16-160	25		50	85	85	85	40	85	85	85	85
NSXm B	16-160	50			85	90	100		85	90	100	100
NSXm F	16-160	85				90	100			90	100	100
NSXm N	16-160	90					100				100	100
NSXm H	16-160	100									100	100
NSX100B	16-100	40							85	90	100	100
NSX100F	16-100	85								90	100	120
NSX100N	16-100	90									100	120
NSX100H	16-100	100										120
NSX100S	16-100	120										150

# Cascading

Upstream: Compact NSX160, NSX250

Downstream: iDPN, iC60, C120, NG125, Compact NSXm, NSX100, NSX160, NSX250

Ue: 220-240 V AC  
(Ph/N 110-130 V AC)



Upstream CB	NSX160						NSX250					
	B	F	N	H	S	L	B	F	N	H	S	L
Icu (kA)	40	85	90	100	120	150	40	85	90	100	120	150

Downstream CB														
	Rating (A)	Icu (kA)	Reinforced breaking capacity (kA)											
iDPN	1-40	10	20	20	20	20	20	20	20	20	20	20	20	20
iDPN N	1-16	15	30	30	30	30	30	30	30	30	30	30	30	30
	25-40	15	30	30	30	30	30	30	30	30	30	30	30	30
iC60N	0.5-40	20	40	40	60	60	60	60	40	40	60	60	60	60
	50-63	20	40	40	60	60	60	60	40	40	60	60	60	60
iC60H	0.5-40	30	40	50	80	80	80	80	40	50	65	65	65	65
	50-63	30	40	50	80	80	80	80	40	50	65	65	65	65
iC60L	0.5-25	50		65	80	80	80	80		65	80	80	80	80
	32-40	36	40	65	80	80	80	80	40	65	80	80	80	80
	50-63	30	40	65	80	80	80	80	40	65	80	80	80	80
C120N	63-125	20	40	40	50	50	70	70	40	40	50	50	70	70
C120H	63-125	30	40	40	50	50	70	70	40	40	50	50	70	70
NG125N	1-125	50		60	70	70	85	85		60	70	70	85	85
NG125H	1-125	70		85	85	85	85	85		85	85	85	85	85
NG125L	1-80	100												
NSXm E	16-160	25	40	85	85	85	85	85	40	85	85	85	85	85
NSXm B	16-160	50		85	90	100	100	100		85	90	100	100	100
NSXm F	16-160	85			90	100	100	100			90	100	100	100
NSXm N	16-160	90				100	100	100				100	100	100
NSXm H	16-160	100												
NSX100B	16-100	40		85	90	90	100	100		85	90	90	100	100
NSX100F	16-100	85			90	100	120	120			90	100	120	120
NSX100N	16-100	90				100	120	150				100	120	150
NSX100H	16-100	100					120	150					120	150
NSX100S	16-100	120						150						150
NSX100L	16-100	150												
NSX160B	16-160	40		85	90	90	100	100		85	90	90	100	100
NSX160F	16-160	85			90	100	120	120			90	100	120	120
NSX160N	16-160	90				100	120	150				100	120	150
NSX160H	16-160	100					120	150					120	150
NSX160S	16-160	120						150						150
NSX160L	16-160	150												
NSX250B	16-250	40								85	90	90	100	100
NSX250F	16-250	85									90	100	120	120
NSX250N	16-250	90										100	120	150
NSX250H	16-250	100											120	150
NSX250S	16-250	120												150
NSX250L	16-250	150												

# Cascading

Upstream: Compact NSX400, NSX630

Downstream: Compact NSX100, NSX160, NSX250, NSX400, NSX630

A

Ue: 220-240 V AC  
(Ph/N 110-130 V AC)

Upstream CB	NSX400					NSX630				
	F	N	H	S	L	F	N	H	S	L
Icu (kA)	40	85	100	120	150	40	85	100	120	150

Downstream CB													
	Rating (A)	Icu (kA)	Reinforced breaking capacity (kA)										
NSX100B	16-100	40		85	90	100	100			85	90	100	100
NSX100F	16-100	85			100	120	150				100	120	150
NSX100N	16-100	90			100	120	150				100	120	150
NSX100H	16-100	100				120	150					120	150
NSX100S	16-100	120					150						150
NSX100L	16-100	150											150
NSX160B	16-160	40		85	90	100	100			85	90	100	100
NSX160F	16-160	85			100	120	150				100	120	150
NSX160N	16-160	90			100	120	150				100	120	150
NSX160H	16-160	100				120	150					120	150
NSX160S	16-160	120					150						150
NSX160L	16-160	150											150
NSX250B	16-250	40		85	90	100	100			85	90	100	100
NSX250F	16-250	85			100	120	150				100	120	150
NSX250N	16-250	90			100	120	150				100	120	150
NSX250H	16-250	100				120	150					120	150
NSX250S	16-250	120					150						150
NSX250L	16-250	150											150
NSX400F	250-400	40		85	100	120	150			85	100	120	150
NSX400N	250-400	85			100	120	150				100	120	150
NSX400H	250-400	100				120	150				100	120	150
NSX400S	250-400	120					150					120	150
NSX400L	250-400	150											150
NSX630F	250-630	40								85	100	120	150
NSX630N	250-630	85									100	120	150
NSX630H	250-630	100									100	120	150
NSX630S	250-630	120										120	150
NSX630L	250-630	150											150

# Cascading

Upstream: Compact NS630b-1600, Masterpact MTZ

Downstream: Compact NSX, Compact NS630b-1600

Ue: 220-240 V AC  
(Ph/N 110-130 V AC)

A

Upstream CB	NS630b-1600				MTZ1	MTZ2
	N	H	L <sup>[1]</sup>	LB <sup>[2]</sup>	L1	L1
Icu (kA)	50	70	150	200	150	150

Downstream CB							
	Rating (A)	Icu (kA)	Reinforced breaking capacity (kA)				
NSX100B	16-100	40	50	50	50	50	50
NSX100F	16-100	85			150	150	150
NSX100N	16-100	90			150	150	150
NSX100H	16-100	100			150	150	150
NSX100S	16-100	120			150	200	150
NSX100L	16-100	150				200	
NSX160B	16-160	40	50	50	50	50	50
NSX160F	16-160	85			150	150	150
NSX160N	16-160	90			150	150	150
NSX160H	16-160	100			150	150	150
NSX160S	16-160	120			150	200	150
NSX160L	16-160	150				200	
NSX250B	16-250	40	50	50	50	50	50
NSX250F	16-250	85			150	150	150
NSX250N	16-250	90			150	150	150
NSX250H	16-250	100			150	150	150
NSX250S	16-250	120			150	200	150
NSX250L	16-250	150				200	
NSX400F	250-400	40	50	50	150	150	150
NSX400N	250-400	85			150	150	150
NSX400H	250-400	100			150	150	150
NSX400S	250-400	120			150	200	150
NSX400L	250-400	150				200	
NSX630F	250-630	40	50	50	150	150	150
NSX630N	250-630	85			150	150	150
NSX630H	250-630	100			150	150	150
NSX630S	250-630	120			150	200	150
NSX630L	250-630	150				200	
NS630b-1600N	630-1600	50		70			70

[1] Compact NS630bL, NS800L, NS1000L

[2] Compact NS630bLB, NS800LB

# Selectivity enhanced by cascading



With traditional circuit breakers, cascading between two devices generally results in the loss of selectivity.

With Compact circuit breakers, the selectivity characteristics in the tables remain applicable and are in some cases even enhanced. Protection selectivity is ensured for short-circuit currents greater than the rated breaking capacity of the circuit breaker and even, in some cases, for its enhanced breaking capacity. In the later case, **protection selectivity is total**, i.e. only the downstream device trips for any and all possible faults at its point in the installation.

### Example

Consider a combination between:

- a Compact NSX250H with trip unit TM250D
- a Compact NSX100F with trip unit TM25D.

The selectivity tables indicate total selectivity. Protection selectivity is therefore ensured up to the breaking capacity of the NSX100F, i.e. **36 kA**.

The cascading tables indicate an enhanced breaking capacity of **70 kA**.

The enhanced selectivity tables indicate that in a cascading configuration, selectivity is ensured up to **70 kA**, i.e. for any and all possible faults at that point in the installation.

### Enhanced selectivity tables - 380-415 V

For each combination of two circuit breakers, the tables indicate the:

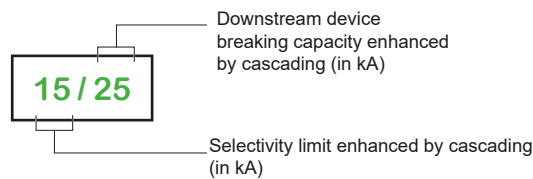

In a table, a box containing two equal values indicates that selectivity is provided up to the reinforced breaking capacity of the downstream device.

These tables apply only to cases with combined selectivity and cascading between two devices. For all other cases, refer to the normal cascading and selectivity tables.

### Technical principle

Enhanced selectivity is the result of the exclusive Compact NSX Roto-active breaking technique which operates as follows:

- due to the short-circuit current (electrodynamic forces), the contacts in both devices simultaneously separate. The result is major limitation of the short-circuit current
- the dissipated energy provokes the reflex tripping of the downstream device, but is insufficient to trip the upstream device.

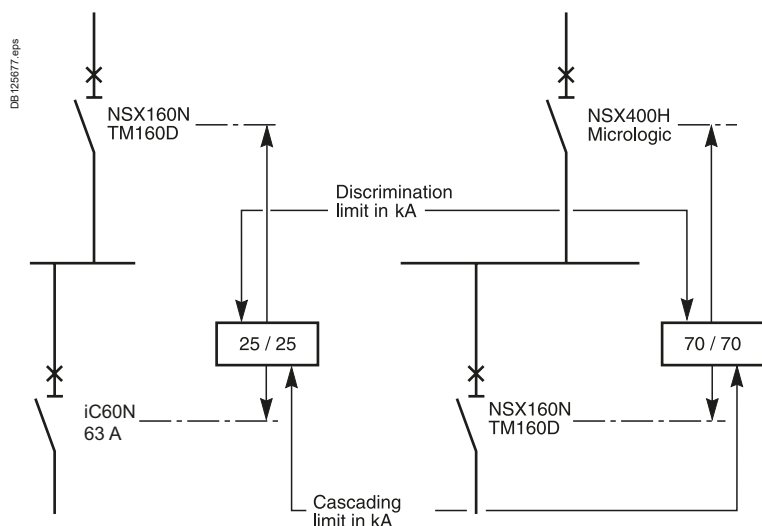

**Note:** respect the basic rules of selectivity, in terms of overload, short-circuit, see page A-2 and A-12.

# Selectivity enhanced by cascading

Upstream: Compact NSXm, Micrologic 4.1, TM-D

Downstream: iC60

Ue: 380-415 V AC  
(Ph/N 220-240 V AC)



Upstream		NSXm					F					N/H				
	Icu (kA)	25					36					50/70				
	Trip unit	Micrologic 4.1														

Downstream		100					160					100					160					
Rating (A)		63	80	100	125	160	63	80	100	125	160	63	80	100	125	160	63	80	100	125	160	
Setting (kA)	Icu (kA)																					
iC60N	≤ 16	10	20/20	20/20	20/20	20/20	20/20	25/25	25/25	25/25	25/25	25/25	25/25	25/30	25/30	25/30	25/30	25/30	25/30	25/30	25/30	
	20	10	20/20	20/20	20/20	20/20	20/20	25/25	25/25	25/25	25/25	25/25	25/25	25/30	25/30	25/30	25/30	25/30	25/30	25/30	25/30	
	25	10		20/20	20/20	20/20	20/20		25/25	25/25	25/25	25/25		25/30	25/30	25/30	25/30	25/30	25/30	25/30	25/30	
	32	10		20/20	20/20	20/20	20/20		25/25	25/25	25/25	25/25		25/30	25/30	25/30	25/30	25/30	25/30	25/30	25/30	25/30
	40	10		16/20	16/20	16/20	16/20		16/25	16/25	16/25	16/25		16/30	16/30	16/30	16/30	16/30	16/30	16/30	16/30	16/30
	50	10			8/20	8/20	8/20	8/20		8/25	8/25	8/25	8/25		8/30	8/30	8/30	8/30	8/30	8/30	8/30	8/30
iC60H	≤ 16	15	25/25	25/25	25/25	25/25	25/25	25/36	25/36	25/36	25/36	25/36	25/36	25/36	25/36	25/36	25/36	25/36	25/36	25/36	25/36	
	20	15	25/25	25/25	25/25	25/25	25/25	25/36	25/36	25/36	25/36	25/36	25/36	25/36	25/36	25/36	25/36	25/36	25/36	25/36	25/36	
	25	15		25/25	25/25	25/25	25/25		25/36	25/36	25/36	25/36		25/36	25/36	25/36	25/36	25/36	25/36	25/36	25/36	
	32	15		25/25	25/25	25/25	25/25		25/36	25/36	25/36	25/36		25/36	25/36	25/36	25/36	25/36	25/36	25/36	25/36	
	40	15		16/25	16/25	16/25	16/25		16/36	16/36	16/36	16/36		16/36	16/36	16/36	16/36	16/36	16/36	16/36	16/36	
	50	15			8/25	8/25	8/25	8/25		8/36	8/36	8/36	8/36		8/36	8/36	8/36	8/36	8/36	8/36	8/36	8/36
iC60L	≤ 16	25	25/25	25/25	25/25	25/25	25/25	25/36	25/36	25/36	25/36	25/36	25/36	25/36	25/36	25/36	25/36	25/36	25/36	25/36	25/36	
	20	25	25/25	25/25	25/25	25/25	25/25	25/36	25/36	25/36	25/36	25/36	25/36	25/36	25/36	25/36	25/36	25/36	25/36	25/36	25/36	
	25	25		25/25	25/25	25/25	25/25		25/36	25/36	25/36	25/36		25/36	25/36	25/36	25/36	25/36	25/36	25/36	25/36	
	32	20		25/25	25/25	25/25	25/25		25/36	25/36	25/36	25/36		25/36	25/36	25/36	25/36	25/36	25/36	25/36	25/36	
	40	20		16/25	16/25	16/25	16/25		16/36	16/36	16/36	16/36		16/36	16/36	16/36	16/36	16/36	16/36	16/36	16/36	
	50	15			8/25	8/25	8/25	8/25		8/36	8/36	8/36	8/36		8/36	8/36	8/36	8/36	8/36	8/36	8/36	8/36

Upstream		NSXm					F					N/H				
	Icu (kA)	25					36					50/70				
	Trip unit	TM-D														
	Rating (A)	≤ 63	80	100	125	160	≤ 63	80	100	125	160	≤ 63	80	100	125	160

Downstream		Reinforced breaking capacity (kA)															
Rating (A)	Icu (kA)																
iC60N	≤ 16	10	-/20	20/20	20/20	20/20	20/20	-/25	25/25	25/25	25/25	25/25	-/30	25/30	25/30	25/30	25/30
	20	10	-/20	20/20	20/20	20/20	20/20	-/25	25/25	25/25	25/25	25/25	-/30	25/30	25/30	25/30	25/30
	25	10		10/20	20/20	20/20	20/20		10/25	25/25	25/25	25/25		10/30	25/30	25/30	25/30
	32	10		3/20	20/20	20/20	20/20		3/25	25/25	25/25	25/25		3/30	25/30	25/30	25/30
	40	10		2/20	16/20	16/20	16/20		2/25	16/25	16/25	16/25		2/30	16/30	16/30	16/30
	50	10			6/20	8/20	8/20			6/25	8/25	8/25		6/30	8/30	8/30	8/30
iC60H	≤ 16	15	-/25	25/25	25/25	25/25	25/25	-/36	25/36	25/36	25/36	25/36	-/36	25/36	25/36	25/36	25/36
	20	15	-/25	25/25	25/25	25/25	25/25	-/36	25/36	25/36	25/36	25/36	-/36	25/36	25/36	25/36	25/36
	25	15		10/25	25/25	25/25	25/25		10/36	25/36	25/36	25/36		10/36	25/36	25/36	25/36
	32	15		3/25	25/25	25/25	25/25		3/36	25/36	25/36	25/36		3/36	25/36	25/36	25/36
	40	15		2/25	16/25	16/25	16/25		2/36	16/36	16/36	16/36		2/36	16/36	16/36	16/36
	50	15			6/25	8/25	8/25			6/36	8/36	8/36		6/36	8/36	8/36	8/36
iC60L	≤ 16	25	-/25	25/25	25/25	25/25	25/25	-/36	25/36	25/36	25/36	25/36	-/36	25/36	25/36	25/36	25/36
	20	25	-/25	25/25	25/25	25/25	25/25	-/36	25/36	25/36	25/36	25/36	-/36	25/36	25/36	25/36	25/36
	25	25		10/25	25/25	25/25	25/25		10/36	25/36	25/36	25/36		10/36	25/36	25/36	25/36
	32	20		3/25	25/25	25/25	25/25		3/36	25/36	25/36	25/36		3/36	25/36	25/36	25/36
	40	20		2/25	16/25	16/25	16/25		2/36	16/36	16/36	16/36		2/36	16/36	16/36	16/36
	50	15			6/25	8/25	8/25			6/36	8/36	8/36		6/36	8/36	8/36	8/36

Note: respect the basic rules of selectivity, in terms of overload, short-circuit, ground fault and earth leakage when applicable see page A-2, or check curves with Schneider Electric online "Electrical calculation tools".

# Selectivity enhanced by cascading

Upstream: Compact NSX100, Micrologic

Downstream: iC60

A

Ue: 380-415 V  
(Ph/N 220-240 V AC)

Upstream		NSX100					
		B	F	N	H	S	L
Icu (kA)		25	36	50	70	100	150
Trip unit		Micrologic [1]					

Downstream		Reinforced breaking capacity (kA)												
Rating (A)		40	100	40	100	40	100	40	100	40	100	40	100	
iC60N	Rating (A)	Reinforced breaking capacity (kA)												
	≤ 20	10	20/20	20/20	25/25	25/25	30/30	30/30	30/30	30/30	30/30	30/30	30/30	30/30
	25	10	20/20	20/20	25/25	25/25	30/30	30/30	30/30	30/30	30/30	30/30	30/30	30/30
	32	10		20/20		25/25		30/30		30/30		30/30		30/30
	40	10		20/20		25/25		30/30		30/30		30/30		30/30
	50	10		6/20		6/25		6/30		6/30		6/30		6/30
iC60H	≤ 20	15	25/25	25/25	36/36	36/36	40/40	40/40	40/40	40/40	40/40	40/40	40/40	40/40
	25	15	25/25	25/25	36/36	36/36	40/40	40/40	40/40	40/40	40/40	40/40	40/40	40/40
	32	15		25/25		36/36		40/40		40/40		40/40		40/40
	40	15		25/25		36/36		40/40		40/40		40/40		40/40
	50	15		6/25		6/36		6/40		6/40		6/40		6/40
	63	15		6/25		6/36		6/40		6/40		6/40		6/40
iC60L	≤ 20	25	25/25	25/25	36/36	36/36	40/40	40/40	40/40	40/40	40/40	40/40	40/40	40/40
	25	25	25/25	25/25	36/36	36/36	40/40	40/40	40/40	40/40	40/40	40/40	40/40	40/40
	32	20		25/25		36/36		40/40		40/40		40/40		40/40
	40	20		25/25		36/36		40/40		40/40		40/40		40/40
	50	15		6/25		6/36		6/40		6/40		6/40		6/40
	63	15		6/25		6/36		6/40		6/40		6/40		6/40

**Note:** respect the basic rules of selectivity, in terms of overload, short-circuit, ground fault and earth leakage when applicable see page A-2, or check curves with Schneider Electric online "Electrical calculation tools".

[1] Applicable for all "Distribution" Micrologic of Compact NSX range: 2.2 4.2, 5.2, 6.2, 7.2. For 4.2 and 7.2 selectivity rules for RCD apply in addition. Applicable for Generators and Service connection (G and AB type) Micrologic of Compact NSX range but curves shall be checked. Not applicable for "Motor" Micrologic of Compact NSX range ("M" type).



# Selectivity enhanced by cascading

Upstream: Compact NSX160, NSX250, Micrologic

Downstream: iC60, C120, NG125, Compact NSXm, NSX100

Ue: 380-415 V AC  
(Ph/N 220-240 V AC)



Upstream		NSX160					
		B	F	N	H	S	L
Icu (kA)		25	36	50	70	100	150
Trip unit		Micrologic [1]					

Downstream		Reinforced breaking capacity (kA)												
Rating (A)		100	160	100	160	100	160	100	160	100	160	100	160	
iC60N	≤ 20	10	20/20	20/20	25/25	25/25	30/30	30/30	30/30	30/30	30/30	30/30	30/30	30/30
	25	10	20/20	20/20	25/25	25/25	30/30	30/30	30/30	30/30	30/30	30/30	30/30	30/30
	32	10	20/20	20/20	25/25	25/25	30/30	30/30	30/30	30/30	30/30	30/30	30/30	30/30
	40	10	20/20	20/20	25/25	25/25	30/30	30/30	30/30	30/30	30/30	30/30	30/30	30/30
	50	10	6/20	20/20	6/25	25/25	6/30	30/30	6/30	30/30	6/30	30/30	6/30	30/30
	63	10	6/20	20/20	6/25	25/25	6/30	30/30	6/30	30/30	6/30	30/30	6/30	30/30
iC60H	20	15	25/25	25/25	36/36	36/36	40/40	40/40	40/40	40/40	40/40	40/40	40/40	40/40
	25	15	25/25	25/25	36/36	36/36	40/40	40/40	40/40	40/40	40/40	40/40	40/40	40/40
	32	15	25/25	25/25	36/36	36/36	40/40	40/40	40/40	40/40	40/40	40/40	40/40	40/40
	40	15	25/25	25/25	36/36	36/36	40/40	40/40	40/40	40/40	40/40	40/40	40/40	40/40
	50	15	6/25	25/25	6/36	36/36	6/36	36/36	6/36	36/36	6/36	36/36	6/36	36/36
	63	15	6/25	25/25	6/36	36/36	6/36	36/36	6/36	36/36	6/36	36/36	6/36	36/36
iC60L	≤ 20	25	25/25	25/25	36/36	36/36	40/40	40/40	40/40	40/40	40/40	40/40	40/40	40/40
	25	25	25/25	25/25	36/36	36/36	40/40	40/40	40/40	40/40	40/40	40/40	40/40	40/40
	32	20	25/25	25/25	36/36	36/36	40/40	40/40	40/40	40/40	40/40	40/40	40/40	40/40
	40	20	25/25	25/25	36/36	36/36	40/40	40/40	40/40	40/40	40/40	40/40	40/40	40/40
	50	15	6/25	25/25	6/36	36/36	6/36	36/36	6/36	36/36	6/36	36/36	6/36	36/36
	63	15	6/25	25/25	6/36	36/36	6/36	36/36	6/36	36/36	6/36	36/36	6/36	36/36

Upstream		NSX250					
		B	F	N	H	S	L
Icu (kA)		25	36	50	70	100	150
Trip unit		Micrologic [1]					

Downstream		Reinforced breaking capacity (kA)					
Rating (A)		250	250	250	250	250	250
iC60N	≤ 40	10	20/20	25/25	30/30	30/30	30/30
	50-63A	10	20/20	25/25	25/25	25/25	25/25
iC60H	≤ 40	15	25/25	30/30	30/30	30/30	30/30
	50-63A	15	25/25	25/25	25/25	25/25	25/25
iC60L	≤ 25	25	25/25	30/30	30/30	30/30	30/30
	32-40	20	25/25	30/30	30/30	30/30	30/30
	50-63	15	25/25	25/25	25/25	25/25	25/25
C120N	10	25/25	25/25	25/25	25/25	25/25	25/25
C120H	15	25/25	25/25	25/25	25/25	25/25	25/25
NG125N	25		36/36	36/36	36/36	36/36	70/70
NG125H	36			40/40	50/50	70/70	100/100
NG125L	50				70/70	100/100	150/150
NSXm E	16	25/25	25/25	30/30	30/30	30/30	30/30
NSXm B	25		36/36	36/36	50/50	50/50	50/50
NSXm F	36			50/50	70/70	70/70	70/70
NSXm N	50				70/70	70/70	70/70
NSX100B	≤ 25	25		36/36	50/50	50/50	50/50
TM-D	40-100	25		36/36	36/50	36/50	36/50
NSX100F	≤ 25	36			70/70	100/100	150/150
TM-D	40-100	36			36/70	36/100	36/150
NSX100N	≤ 25	50			70/70	100/100	150/150
TM-D	40-100	50			36/70	36/100	36/150
NSX100H	≤ 25	70				100/100	150/150
TM-D	40-100	70				36/100	36/150
NSX100S	≤ 25	100					150/150
TM-D	40-100	100					36/150
NSX100B	25		36/36	36/50	36/50	36/50	36/50
Micrologic NSX100F	36				36/70	36/100	36/150
Micrologic NSX100N	50				36/70	36/100	36/150
Micrologic NSX100H	70					36/100	36/150
Micrologic NSX100S	100						36/150

Note: respect the basic rules of selectivity, in terms of overload, short-circuit, ground fault and earth leakage when applicable see page A-2, or check curves with Schneider Electric online "Electrical calculation tools".

[1] Applicable for all "Distribution" Micrologic of Compact NSX range: 2.2 4.2, 5.2, 6.2, 7.2. For 4.2 and 7.2 selectivity rules for RCD apply in addition. Applicable for Generators and Service connection (G and AB type) Micrologic of Compact NSX range but curves shall be checked. Not applicable for "Motor" Micrologic of Compact NSX range ("M" type).

# Selectivity enhanced by cascading

Upstream: Compact NSX160, NSX250, TM-D

Downstream: iC60, C120, NG125, Compact NSXm, NSX100



Ue: 380-415 V AC  
(Ph/N 220-240 V AC)

Upstream		NSX160					
		B	F	N	H	S	L
Icu (kA)		25	36	50	70	100	150
Trip unit		TM-D					

Downstream			Reinforced breaking capacity (kA)											
Rating (A)			≤ 100	125-160	≤ 100	125-160	≤ 100	125-160	≤ 100	125-160	≤ 100	125-160	≤ 100	125-160
iC60N	Rating (A)	Icu (kA)	Reinforced breaking capacity (kA)											
	≤ 20	10	-/20	20/20	-/25	25/25	-/30	30/30	-/30	30/30	-/30	30/30	-/30	30/30
	25	10	-/20	20/20	-/25	25/25	-/30	30/30	-/30	30/30	-/30	30/30	-/30	30/30
	32	10	-/20	20/20	-/25	25/25	-/30	30/30	-/30	30/30	-/30	30/30	-/30	30/30
	40	10	-/20	20/20	-/25	25/25	-/30	30/30	-/30	30/30	-/30	30/30	-/30	30/30
	50	10	-/20	20/20	-/25	25/25	-/30	30/30	-/30	30/30	-/30	30/30	-/30	30/30
iC60H	≤ 20	15	-/25	25/25	-/36	36/36	-/40	40/40	-/40	40/40	-/40	40/40	-/40	40/40
	25	15	-/25	25/25	-/36	36/36	-/40	40/40	-/40	40/40	-/40	40/40	-/40	40/40
	32	15	-/25	25/25	-/36	36/36	-/40	40/40	-/40	40/40	-/40	40/40	-/40	40/40
	40	15	-/25	25/25	-/36	36/36	-/40	40/40	-/40	40/40	-/40	40/40	-/40	40/40
	50	15	-/25	25/25	-/36	36/36	-/36	36/36	-/36	36/36	-/36	36/36	-/36	36/36
	63	15	-/25	25/25	-/36	36/36	-/36	36/36	-/36	36/36	-/36	36/36	-/36	36/36
iC60L	≤ 20	25	-/25	25/25	-/36	36/36	-/40	40/40	-/40	40/40	-/40	40/40	-/40	40/40
	25	25	-/25	25/25	-/36	36/36	-/40	40/40	-/40	40/40	-/40	40/40	-/40	40/40
	32	20	-/25	25/25	-/36	36/36	-/40	40/40	-/40	40/40	-/40	40/40	-/40	40/40
	40	20	-/25	25/25	-/36	36/36	-/40	40/40	-/40	40/40	-/40	40/40	-/40	40/40
	50	15	-/25	25/25	-/36	36/36	-/36	36/36	-/36	36/36	-/36	36/36	-/36	36/36
	63	15	-/25	25/25	-/36	36/36	-/36	36/36	-/36	36/36	-/36	36/36	-/36	36/36

Upstream		NSX250					
		B	F	N	H	S	L
Icu (kA)		25	36	50	70	100	130
Trip unit		TM-D					

Downstream			Reinforced breaking capacity (kA)					
Rating (A)			200-250	200-250	200-250	200-250	200-250	200-250
iC60N	Rating (A)	Icu (kA)	Reinforced breaking capacity (kA)					
	≤ 40	10	20/20	25/25	30/30	30/30	30/30	30/30
iC60H	50-63	10	20/20	25/25	30/30	30/30	30/30	30/30
	≤ 40	15	25/25	30/30	30/30	30/30	30/30	30/30
iC60L	50-63	15	25/25	25/25	25/25	25/25	25/25	25/25
	≤ 25	25	25/25	30/30	30/30	30/30	30/30	30/30
	32-40	20	25/25	30/30	30/30	30/30	30/30	30/30
C120N	50-63	15	25/25	25/25	25/25	25/25	25/25	25/25
	≤ 10	10	25/25	25/25	25/25	25/25	25/25	25/25
C120H		15	25/25	25/25	25/25	25/25	25/25	25/25
NG125N		25		36/36	36/36	36/36	50/50	70/70
NG125H		36			40/40	50/50	70/70	100/100
NG125L		50				70/70	100/100	150/150
NSXm E	≤ 125	16	25/25	25/25	30/30	30/30	30/30	30/30
NSXm B	≤ 125	25		36/36	36/36	50/50	50/50	50/50
NSXm F	≤ 125	36			50/50	70/70	70/70	70/70
NSXm N	≤ 125	50				70/70	70/70	70/70
NSX100B	≤ 25	25		36/36	36/36	50/50	50/50	50/50
TM-D	40 - 100	25		36/36	36/36	36/50	36/50	36/50
NSX100F	≤ 25	36			50/50	70/70	100/100	150/150
TM-D	40 - 100	36			36/50	36/70	36/100	36/150
NSX100N	≤ 25	50				70/70	100/100	150/150
TM-D	40 - 100	50				36/70	36/100	36/150
NSX100H	≤ 25	70					100/100	150/150
TM-D	40 - 100	70					36/100	36/150
NSX100S	≤ 25	100						150/150
TM-D	40 - 100	70						36/150
NSX100B		25		2/36	2/36	2/50	2/50	2/50
Micrologic								
NSX100F		36			2/50	2/70	2/100	2/150
Micrologic								
NSX100N		50				2/70	2/100	2/150
Micrologic								
NSX100H		70					2/100	2/150
Micrologic								
NSX100S		100						2/150
Micrologic								

Note: respect the basic rules of selectivity, in terms of overload, short-circuit, ground fault and earth leakage when applicable see page A-2, or check curves with Schneider Electric online "Electrical calculation tools".

# Selectivity enhanced by cascading

Upstream: Compact NSX400, NSX630, Micrologic

Downstream: Compact NSXm, NSX100, NSX160, NSX250

Ue: 380-415 V AC  
(Ph/N 220-240 V AC)



Upstream	NSX400					NSX630				
	F	N	H	S	L	F	N	H	S	L
Icu (kA)	36	50	70	100	150	36	50	70	100	150
Trip unit	Micrologic [1]									

Downstream			400	400	400	400	400	630	630	630	630	630
Rating (A)	Trip unit	Icu (kA)	Reinforced breaking capacity (kA)									
NSXm E	TM-D	16	25/25	30/30	30/30	30/30	30/30	25/25	30/30	30/30	30/30	30/30
NSXm B	TM-D	25	36/36	36/36	50/50	50/50	50/50	36/36	36/36	50/50	50/50	50/50
NSXm F	TM-D	36		50/50	70/70	70/70	70/70		50/50	70/70	70/70	70/70
NSXm N	TM-D	50			70/70	70/70	70/70			70/70	70/70	70/70
NSXm E	Micrologic	16	25/25	30/30	30/30	30/30	30/30	25/25	30/30	30/30	30/30	30/30
NSXm B	Micrologic	25	36/36	36/36	50/50	50/50	50/50	36/36	36/36	50/50	50/50	50/50
NSXm F	Micrologic	36		50/50	70/70	70/70	70/70		50/50	70/70	70/70	70/70
NSXm N	Micrologic	50			70/70	70/70	70/70			70/70	70/70	70/70
NSX100B	TM-D	25	36/36	36/36	50/50	50/50	50/50	36/36	36/36	50/50	50/50	50/50
NSX100F	TM-D	36		50/50	70/70	100/100	150/150		50/50	70/70	100/100	150/150
NSX100N	TM-D	50			70/70	100/100	150/150			70/70	100/100	150/150
NSX100H	TM-D	70				100/100	150/150				100/100	150/150
NSX100S	TM-D	100					150/150					150/150
NSX160B	TM-D	25	36/36	36/36	50/50	50/50	50/50	36/36	36/36	50/50	50/50	50/50
NSX160F	TM-D	36		50/50	70/70	100/100	150/150		50/50	70/70	100/100	150/150
NSX160N	TM-D	50			70/70	100/100	150/150			70/70	100/100	150/150
NSX160H	TM-D	70				100/100	150/150				100/100	150/150
NSX160S	TM-D	100					150/150					150/150
NSX250B	TM-D	25						36/36	36/36	50/50	50/50	50/50
NSX250F	TM-D	36							50/50	70/70	100/100	150/150
NSX250N	TM-D	50								70/70	100/100	150/150
NSX250H	TM-D	70									100/100	150/150
NSX250S	TM-D	100										150/150
NSX100B	Micrologic	25	36/36	36/36	50/50	50/50	50/50	36/36	36/36	50/50	50/50	50/50
NSX100F	Micrologic	36		50/50	70/70	100/100	150/150		50/50	70/70	100/100	150/150
NSX100N	Micrologic	50			70/70	100/100	150/150			70/70	100/100	150/150
NSX100H	Micrologic	70				100/100	150/150				100/100	150/150
NSX100S	Micrologic	100					150/150					150/150
NSX160B	Micrologic	25	36/36	36/36	50/50	50/50	50/50	36/36	36/36	50/50	50/50	50/50
NSX160F	Micrologic	36		50/50	70/70	100/100	150/150		50/50	70/70	100/100	150/150
NSX160N	Micrologic	50			70/70	100/100	150/150			70/70	100/100	150/150
NSX160H	Micrologic	70				100/100	150/150				100/100	150/150
NSX160S	Micrologic	100					150/150					150/150
NSX250B	Micrologic	25						36/36	36/36	50/50	50/50	50/50
NSX250F	Micrologic	36							50/50	70/70	100/100	150/150
NSX250N	Micrologic	50								70/70	100/100	150/150
NSX250H	Micrologic	70									100/100	150/150
NSX250S	Micrologic	100										150/150

**Note:** respect the basic rules of selectivity, in terms of overload, short-circuit, ground fault and earth leakage when applicable see page A-2, or check curves with Schneider Electric online "Electrical calculation tools".

**[1]** Applicable for all "Distribution" Micrologic of Compact NSX range: 2.3 4.3, 5.3, 6.3, 7.3. For 4.3 and 7.3 selectivity rules for RCD apply in addition. Applicable for Generators and Service connection (G and AB type) Micrologic of Compact NSX range but curves shall be checked Not applicable for "Motor" Micrologic of Compact NSX range ("M" type).

# Selectivity enhanced by cascading

Upstream: Compact NS800, NS1000, NS1250, NS1600, Micrologic

Downstream: Compact NSX100, NSX160, NSX250, NSX400, NSX630

A

Ue: 380-415 V AC  
(Ph/N 220-240 V AC)

Upstream	NS800				NS1000			NS1250		NS1600	
	N	H	L	LB	N	H	L	N	H	N	H
Icu (kA)	50	70	150	200	50	70	150	50	70	50	70
Trip unit	Micrologic										

Downstream													
Rating (A)		800	800	800	800	1000	1000	1000	1250	1250	1600	1600	
	Trip unit	Icu (kA)	Reinforced breaking capacity (kA)										
NSX100B	TM-D / Micrologic	25	50/50	50/50	50/50	50/50	50/50	50/50	50/50	50/50	50/50	50/50	
NSX100F	TM-D / Micrologic	36	50/50	70/70	150/150	150/150	50/50	70/70	150/150	50/50	70/70	50/50	70/70
NSX100N	TM-D / Micrologic	50		70/70	150/150	150/150		70/70	150/150		70/70		70/70
NSX100H	TM-D / Micrologic	70			150/150	150/150			150/150				
NSX100S	TM-D / Micrologic	100			150/150	200/200			150/150				
NSX100L	TM-D / Micrologic	150				200/200							
NSX160B	TM-D / Micrologic	25	50/50	50/50	50/50	50/50	50/50	50/50	50/50	50/50	50/50	50/50	
NSX160F	TM-D / Micrologic	36	50/50	70/70	150/150	150/150	50/50	70/70	150/150	50/50	70/70	50/50	70/70
NSX160N	TM-D / Micrologic	50		70/70	150/150	150/150		70/70	150/150		70/70		70/70
NSX160H	TM-D / Micrologic	70			150/150	150/150			150/150				
NSX160S	TM-D / Micrologic	100			150/150	200/200			150/150				
NSX160L	TM-D / Micrologic	150				200/200							
NSX250B	TM-D / Micrologic	25	50/50	50/50	50/50	50/50	50/50	50/50	50/50	50/50	50/50	50/50	
NSX250F	TM-D / Micrologic	36	50/50	70/70	150/150	150/150	50/50	70/70	150/150	50/50	70/70	50/50	70/70
NSX250N	TM-D / Micrologic	50		70/70	150/150	150/150		70/70	150/150		70/70		70/70
NSX250H	TM-D / Micrologic	70			150/150	150/150			150/150				
NSX250S	TM-D / Micrologic	100			150/150	200/200			150/150				
NSX250L	TM-D / Micrologic	150				200/200							
NSX400F	Micrologic	36	50/50	70/70	10/150	10/150	50/50	70/70	15/150	50/50	70/70	50/50	70/70
NSX400N	Micrologic	50		70/70	10/150	10/150		70/70	15/150		70/70		70/70
NSX400H	Micrologic	70			10/150	10/150			15/150				
NSX400S	Micrologic	100			10/150	10/200			15/150				
NSX400L	Micrologic	150				10/200							
NSX630F	Micrologic	36					50/50	65/70	10/150	50/50	65/70	50/50	65/70
NSX630N	Micrologic	50						65/70	10/150		65/70		65/70
NSX630H	Micrologic	70							10/150				
NSX630S	Micrologic	100							10/150				

**Note:** respect the basic rules of selectivity, in terms of overload, short-circuit, ground fault and earth leakage when applicable see page A-2, or check curves with Schneider Electric online "Electrical calculation tools".

# Selectivity enhanced by cascading

Upstream: Compact NSXm, Micrologic, TM-D

Downstream: iC60

Ue: 440 V AC



Upstream		NSXm					F					N/H				
		B														
Icu (kA)		20					35					50/65				
Trip unit		Micrologic 4.1														

Downstream			100					160					100					160									
Rating (A)			63					80					100					125					160				
Setting (kA)			63					80					100					125					160				
Rating (A)			63					80					100					125					160				
Icu (kA)			63					80					100					125					160				
iC60N	≤ 16	6	15/15	15/15	15/15	15/15	15/15	15/15	15/15	15/15	15/15	15/15	15/15	15/15	15/15	20/20	20/20	20/20	20/20	20/20							
	20	6	15/15	15/15	15/15	15/15	15/15	15/15	15/15	15/15	15/15	15/15	15/15	15/15	20/20	20/20	20/20	20/20	20/20								
	25	6		15/15	15/15	15/15	15/15	15/15		15/15	15/15	15/15	15/15		20/20	20/20	20/20	20/20	20/20								
	32	6		15/15	15/15	15/15	15/15	15/15		15/15	15/15	15/15	15/15		20/20	20/20	20/20	20/20	20/20								
	40	6		15/15	15/15	15/15	15/15	15/15		15/15	15/15	15/15	15/15		16/20	16/20	16/20	16/20	16/20								
	50	6			8/15	8/15	8/15	8/15			8/15	8/15	8/15	8/15		8/20	8/20	8/20	8/20	8/20							
iC60H	≤ 16	10	20/20	20/20	20/20	20/20	20/20	20/20	20/20	20/20	20/20	20/20	20/20	25/25	25/25	25/25	25/25	25/25	25/25								
	20	10	20/20	20/20	20/20	20/20	20/20	20/20	20/20	20/20	20/20	20/20	20/20	25/25	25/25	25/25	25/25	25/25	25/25								
	25	10		20/20	20/20	20/20	20/20	20/20		20/20	20/20	20/20	20/20		25/25	25/25	25/25	25/25	25/25								
	32	10		20/20	20/20	20/20	20/20	20/20		20/20	20/20	20/20	20/20		25/25	25/25	25/25	25/25	25/25								
	40	10		16/20	16/20	16/20	16/20	16/20		16/20	16/20	16/20	16/20		16/25	16/25	16/25	16/25	16/25								
	50	10			8/20	8/20	8/20	8/20			8/20	8/20	8/20		8/25	8/25	8/25	8/25	8/25								
iC60L	≤ 16	20	20/20	20/20	20/20	20/20	20/20	20/20	20/20	20/20	20/20	20/20	20/20	25/25	25/25	25/25	25/25	25/25	25/25								
	20	20	20/20	20/20	20/20	20/20	20/20	20/20	20/20	20/20	20/20	20/20	20/20	25/25	25/25	25/25	25/25	25/25	25/25								
	25	20		20/20	20/20	20/20	20/20	20/20		20/20	20/20	20/20	20/20		25/25	25/25	25/25	25/25	25/25								
	32	20		20/20	20/20	20/20	20/20	20/20		20/20	20/20	20/20	20/20		25/25	25/25	25/25	25/25	25/25								
	40	20		16/20	16/20	16/20	16/20	16/20		16/20	16/20	16/20	16/20		16/25	16/25	16/25	16/25	16/25								
	50	10			8/20	8/20	8/20	8/20			8/20	8/20	8/20		8/25	8/25	8/25	8/25	8/25								

Upstream		NSXm					F					N / H				
		B														
Icu (kA)		20					35					50 / 65				
Trip unit		TM-D														

Downstream			≤ 63					80					100					125					160				
Rating (A)			≤ 63					80					100					125					160				
Rating (A)			≤ 63					80					100					125					160				
Icu (kA)			≤ 63					80					100					125					160				
			Reinforced breaking capacity (kA)																								
iC60N	≤ 16	6	-/15	15/15	15/15	15/15	15/15	-/15	15/15	15/15	15/15	15/15	15/15	-/20	20/20	20/20	20/20	20/20									
	20	6	-/15	15/15	15/15	15/15	15/15	-/15	15/15	15/15	15/15	15/15	15/15	-/20	20/20	20/20	20/20	20/20									
	25	6		8/15	15/15	15/15	15/15		8/15	15/15	15/15	15/15		8/20	20/20	20/20	20/20										
	32	6		3/15	15/15	15/15	15/15		3/15	15/15	15/15	15/15		3/20	20/20	20/20	20/20										
	40	6		2/15	15/15	15/15	15/15		2/15	15/15	15/15	15/15		2/20	16/20	16/20	16/20										
	50	6			6/15	8/15	8/15			6/15	8/15	8/15			6/20	8/20	8/20										
iC60H	≤ 16	10	-/20	20/20	20/20	20/20	20/20	-/20	20/20	20/20	20/20	20/20	-/25	25/25	25/25	25/25	25/25										
	20	10	-/20	20/20	20/20	20/20	20/20	-/20	20/20	20/20	20/20	20/20	-/25	25/25	25/25	25/25	25/25										
	25	10		8/20	20/20	20/20	20/20		8/20	20/20	20/20	20/20		8/25	25/25	25/25	25/25										
	32	10		3/20	20/20	20/20	20/20		3/20	20/20	20/20	20/20		3/25	25/25	25/25	25/25										
	40	10		2/20	16/20	16/20	16/20		2/20	16/20	16/20	16/20		2/25	16/25	16/25	16/25										
	50	10			6/20	8/20	8/20			6/20	8/20	8/20			6/25	8/25	8/25										
iC60L	≤ 16	20	-/20	20/20	20/20	20/20	20/20	-/20	20/20	20/20	20/20	20/20	-/25	25/25	25/25	25/25	25/25										
	20	20	-/20	20/20	20/20	20/20	20/20	-/20	20/20	20/20	20/20	20/20	-/25	25/25	25/25	25/25	25/25										
	25	20		8/20	20/20	20/20	20/20		8/20	20/20	20/20	20/20		8/25	25/25	25/25	25/25										
	32	15		3/20	20/20	20/20	20/20		3/20	20/20	20/20	20/20		3/25	25/25	25/25	25/25										
	40	15		2/20	16/20	16/20	16/20		2/20	16/20	16/20	16/20		2/25	16/25	16/25	16/25										
	50	10			6/20	8/20	8/20			6/20	8/20	8/20			6/25	8/25	8/25										

Note: respect the basic rules of selectivity, in terms of overload, short-circuit, ground fault and earth leakage when applicable see page A-2, or check curves with Schneider Electric online "Electrical calculation tools".

# Selectivity enhanced by cascading

Upstream: Compact NSX100, Micrologic

Downstream: iC60



Ue: 440 V AC

Upstream		NSX100					
		B	F	N	H	S	L
Icu (kA)	20	35	50	65	90	130	
Trip unit	Micrologic [1]						

Downstream														
Rating (A)		40	100	40	100	40	100	40	100	40	100	40	100	40
		Reinforced breaking capacity (kA)												
iC60N	≤ 20	6	15/15	15/15	15/15	15/15	20/20	20/20	20/20	20/20	20/20	20/20	20/20	20/20
	25	6	15/15	15/15	15/15	15/15	20/20	20/20	20/20	20/20	20/20	20/20	20/20	20/20
	32	6		15/15		15/15		20/20		20/20		20/20		20/20
	40	6		15/15		15/15		20/20		20/20		20/20		20/20
	50	6		6/15		6/15		6/20		6/20		6/20		6/20
	63	6		6/15		6/15		6/20		6/20		6/20		6/20
iC60H	≤ 20	10	20/20	20/20	20/20	20/20	25/25	25/25	25/25	25/25	25/25	25/25	25/25	25/25
	25	10	20/20	20/20	20/20	20/20	25/25	25/25	25/25	25/25	25/25	25/25	25/25	25/25
	32	10		20/20		20/20		25/25		25/25		25/25		25/25
	40	10		20/20		20/20		25/25		25/25		25/25		25/25
	50	10		6/20		6/20		6/25		6/25		6/25		6/25
	63	10		6/20		6/20		6/25		6/25		6/25		6/25
iC60L	≤ 20	20	20/20	20/20	20/20	20/20	25/25	25/25	25/25	25/25	25/25	25/25	25/25	25/25
	25	20	20/20	20/20	20/20	20/20	25/25	25/25	25/25	25/25	25/25	25/25	25/25	25/25
	32	15		20/20		20/20		25/25		25/25		25/25		25/25
	40	15		20/20		20/20		25/25		25/25		25/25		25/25
	50	10		6/20		6/20		6/25		6/25		6/25		6/25
	63	10		6/20		6/20		6/25		6/25		6/25		6/25

**Note:** respect the basic rules of selectivity, in terms of overload, short-circuit, ground fault and earth leakage when applicable see page A-2, or check curves with Schneider Electric online "Electrical calculation tools".  
**[1]** Applicable for all "Distribution" Micrologic of Compact NSX range: 2.2 4.2, 5.2, 6.2, 7.2. For 4.2 and 7.2 selectivity rules for RCD apply in addition. Applicable for Generators and Service connection (G and AB type) Micrologic of Compact NSX range but curves shall be checked. Not applicable for "Motor" Micrologic of Compact NSX range ("M" type).

# Selectivity enhanced by cascading

Upstream: Compact NSX160, NSX250, Micrologic

Downstream: iC60, NG125, Compact NSXm, NSX100

Ue: 440 V AC



Upstream		NSX160					
		B	F	N	H	S	L
	Icu (kA)	20	35	50	65	90	130
	Trip unit	Micrologic [1]					

Downstream		Reinforced breaking capacity (kA)												
Rating (A)		100	160	100	160	100	160	100	160	100	160	100	160	
iC60N	Rating (A)	Reinforced breaking capacity (kA)												
	Icu (kA)	Reinforced breaking capacity (kA)												
	≤ 20	6	15/15	15/15	15/15	15/15	20/20	20/20	20/20	20/20	20/20	20/20	20/20	20/20
	25	6	15/15	15/15	15/15	15/15	20/20	20/20	20/20	20/20	20/20	20/20	20/20	20/20
	32	6	15/15	15/15	15/15	15/15	20/20	20/20	20/20	20/20	20/20	20/20	20/20	20/20
	40	6	15/15	15/15	15/15	15/15	20/20	20/20	20/20	20/20	20/20	20/20	20/20	20/20
iC60H	20	10	20/20	20/20	20/20	20/20	25/25	25/25	25/25	25/25	25/25	25/25	25/25	
	25	10	20/20	20/20	20/20	20/20	25/25	25/25	25/25	25/25	25/25	25/25	25/25	
	32	10	20/20	20/20	20/20	20/20	25/25	25/25	25/25	25/25	25/25	25/25	25/25	
	40	10	20/20	20/20	20/20	20/20	25/25	25/25	25/25	25/25	25/25	25/25	25/25	
	50	10	6/20	20/20	6/20	20/20	6/25	25/25	6/25	25/25	6/25	25/25	6/25	
	63	10	6/20	20/20	6/20	20/20	6/25	25/25	6/25	25/25	6/25	25/25	6/25	
iC60L	≤ 20	20	20/20	20/20	20/20	20/20	25/25	25/25	25/25	25/25	25/25	25/25	25/25	
	25	20	20/20	20/20	20/20	20/20	25/25	25/25	25/25	25/25	25/25	25/25	25/25	
	32	15	20/20	20/20	20/20	20/20	25/25	25/25	25/25	25/25	25/25	25/25	25/25	
	40	15	20/20	20/20	20/20	20/20	25/25	25/25	25/25	25/25	25/25	25/25	25/25	
	50	10	6/20	20/20	6/20	20/20	6/25	25/25	6/25	25/25	6/25	25/25	6/25	
	63	10	6/20	20/20	6/20	20/20	6/25	25/25	6/25	25/25	6/25	25/25	6/25	
NG125N	≤ 20	20				35/35		35/35		35/35		50/50	65/65	
NG125H	≤ 20	30						40/40		50/50		65/65	90/90	
NG125L	≤ 20	40						50/50		65/65		90/90	130/130	

Upstream		NSX250					
		B	F	N	H	S	L
	Icu (kA)	20	35	50	65	90	130
	Trip unit	Micrologic [1]					

Downstream		Reinforced breaking capacity (kA)					
Rating (A)		250	250	250	250	250	250
NG125N	20			35/35		35/35	50/50
NG125H	30					40/40	65/65
NG125L	40						90/90
NSXm E	15	20/20	20/20	30/30	30/30	30/30	30/30
NSXm B	20		35/35	35/35	50/50	50/50	50/50
NSXm F	35			50/50	65/65	65/65	65/65
NSXm N	50				65/65	65/65	65/65
NSX100B	≤ 25		35/35	35/35	50/50	50/50	50/50
TM-D	40 - 100		35/35	35/35	36/50	36/50	36/50
NSX100F	≤ 25			50/50	65/65	90/90	130/130
TM-D	40 - 100			36/50	36/65	36/90	36/130
NSX100N	≤ 25				65/65	90/90	130/130
TM-D	40 - 100				36/65	36/90	36/130
NSX100H	≤ 25					90/90	130/130
TM-D	40 - 100					36/90	36/130
NSX100S	≤ 25						130/130
TM-D	40 - 100						36/130
NSX100B	20		35/35	35/35	35/50	35/50	35/50
Micrologic							
NSX100F	35			35/50	35/50	35/90	35/130
Micrologic							
NSX100N	50				35/65	35/90	35/130
Micrologic							
NSX100H	65					35/90	35/130
Micrologic							
NSX100S	90						35/130
Micrologic							

Note: respect the basic rules of selectivity, in terms of overload, short-circuit, ground fault and earth leakage when applicable see page A-2, or check curves with Schneider Electric online "Electrical calculation tools".

[1] Applicable for all "Distribution" Micrologic of Compact NSX range: 2.2 4.2, 5.2, 6.2, 7.2. For 4.2 and 7.2 selectivity rules for RCD apply in addition. Applicable for Generators and Service connection (G and AB type) Micrologic of Compact NSX range but curves shall be checked. Not applicable for "Motor" Micrologic of Compact NSX range ("M" type).

# Selectivity enhanced by cascading

Upstream: Compact NSX160, NSX250, TM-D

Downstream: iC60, NG125, Compact NSXm, NSX100

Ue: 440 V AC

A

Upstream		NSX160					
		B	F	N	H	S	L
Icu (kA)		20	35	50	65	90	130
Trip unit		TM-D					

Downstream		Reinforced breaking capacity (kA)												
Rating (A)		≤ 100	125-160	≤ 100	125-160	≤ 100	125-160	≤ 100	125-160	≤ 100	125-160	≤ 100	125-160	
iC60N	Rating (A)	Reinforced breaking capacity (kA)												
	Icu (kA)	Reinforced breaking capacity (kA)												
	20	6	-/15	15/15	-/15	15/15	-/20	20/20	-/20	20/20	-/20	20/20	-/20	20/20
	25	6	-/15	15/15	-/15	15/15	-/20	20/20	-/20	20/20	-/20	20/20	-/20	20/20
	32	6	-/15	15/15	-/15	15/15	-/20	20/20	-/20	20/20	-/20	20/20	-/20	20/20
iC60H	≤ 20	10	-/20	20/20	-/20	20/20	-/25	25/25	-/25	25/25	-/25	25/25	-/25	25/25
	25	10	-/20	20/20	-/20	20/20	-/25	25/25	-/25	25/25	-/25	25/25	-/25	25/25
	32	10	-/20	20/20	-/20	20/20	-/25	25/25	-/25	25/25	-/25	25/25	-/25	25/25
	40	10	-/20	20/20	-/20	20/20	-/25	25/25	-/25	25/25	-/25	25/25	-/25	25/25
	50	10	-/20	20/20	-/20	20/20	-/25	25/25	-/25	25/25	-/25	25/25	-/25	25/25
iC60L	≤ 20	20	-/20	20/20	-/20	20/20	-/25	25/25	-/25	25/25	-/25	25/25	-/25	25/25
	25	20	-/20	20/20	-/20	20/20	-/25	25/25	-/25	25/25	-/25	25/25	-/25	25/25
	32	15	-/20	20/20	-/20	20/20	-/25	25/25	-/25	25/25	-/25	25/25	-/25	25/25
	40	15	-/20	20/20	-/20	20/20	-/25	25/25	-/25	25/25	-/25	25/25	-/25	25/25
	50	10	-/20	20/20	-/20	20/20	-/25	25/25	-/25	25/25	-/25	25/25	-/25	25/25
NG125N	≤ 20	20				35/35		35/35		35/35		50/50		65/65
NG125H	≤ 20	30				35/35		40/40		50/50		65/65		90/90
NG125L	≤ 20	40						50/50		65/65		90/90		130/130

Upstream		NSX250					
		B	F	N	H	S	L
Icu (kA)		20	35	50	65	90	130
Trip unit		TM-D					

Downstream		Reinforced breaking capacity (kA)					
Rating (A)		200-250	200-250	200-250	200-250	200-250	200-250
NG125N	Rating (A)	Reinforced breaking capacity (kA)					
	Icu (kA)	Reinforced breaking capacity (kA)					
NG125H	30		35/35	40/40	50/50	65/65	90/90
NG125L	40				65/65	90/90	130/130
NSXm E	≤ 125	10	20/20	30/30	30/30	30/30	30/30
NSXm B	≤ 125	20		35/35	50/50	50/50	50/50
NSXm F	≤ 125	35		50/50	65/65	65/65	65/65
NSXm N	≤ 125	50			65/65	65/65	65/65
NSX100B	≤ 25	25		35/35	50/50	50/50	50/50
TM-D	40 - 100		35/35	35/35	36/50	36/50	36/50
NSX100F	≤ 25	36		50/50	65/65	90/90	130/130
TM-D	40 - 100			36/50	36/65	36/90	36/130
NSX100N	≤ 25	50			65/65	90/90	130/130
TM-D	40 - 100				36/65	36/90	36/130
NSX100H	≤ 25	70				90/90	130/130
TM-D	40 - 100					36/90	36/130
NSX100S	≤ 25	100					130/130
TM-D	40 - 100						36/130
NSX100B		25		2/35	2/50	2/50	2/50
Micrologic							
NSX100F		36		2/50	2/50	2/90	2/130
Micrologic							
NSX100N		50			2/65	2/90	2/130
Micrologic							
NSX100H		70				2/90	2/130
Micrologic							
NSX100S		100					2/130
Micrologic							

Note: respect the basic rules of selectivity, in terms of overload, short-circuit, ground fault and earth leakage when applicable see page A-2, or check curves with Schneider Electric online "Electrical calculation tools".



# Selectivity enhanced by cascading

Upstream: Compact NSX400, NSX630, Micrologic

Downstream: Compact NSXm, NSX100, NSX160, NSX250

Ue: 440 V AC



Upstream	NSX400					NSX630				
	F	N	H	S	L	F	N	H	S	L
Icu (kA)	30	42	65	90	130	30	42	65	90	130
Trip unit	Micrologic [1]									

Downstream			400	400	400	400	400	630	630	630	630	630
Rating (A)	Trip unit	Icu (kA)	Reinforced breaking capacity (kA)									
NSXm E	TM-D	10	20/20	30/30	30/30	30/30	30/30	20/20	30/30	30/30	30/30	30/30
NSXm B	TM-D	20	30/30	30/30	50/50	50/50	50/50	30/30	30/30	50/50	50/50	50/50
NSXm F	TM-D	35		42/42	65/65	65/65	65/65		42/42	65/65	65/65	65/65
NSXm N	TM-D	50			65/65	65/65	65/65			65/65	65/65	65/65
NSXm E	Micrologic	10	20/20	30/30	30/30	30/30	30/30	20/20	30/30	30/30	30/30	30/30
NSXm B	Micrologic	20	30/30	30/30	50/50	50/50	50/50	30/30	30/30	50/50	50/50	50/50
NSXm F	Micrologic	35		42/42	65/65	65/65	65/65		42/42	65/65	65/65	65/65
NSXm N	Micrologic	50			65/65	65/65	65/65			65/65	65/65	65/65
NSX100B	TM-D	20	30/30	30/30	50/50	50/50	50/50	30/30	30/30	50/50	50/50	50/50
NSX100F	TM-D	35		42/42	65/65	90/90	130/130		42/42	65/65	90/90	130/130
NSX100N	TM-D	50			65/65	90/90	130/130			65/65	90/90	130/130
NSX100H	TM-D	65				90/90	130/130				90/90	130/130
NSX100S	TM-D	90					130/130					130/130
NSX160B	TM-D	20	30/30	30/30	50/50	50/50	50/50	30/30	30/30	50/50	50/50	50/50
NSX160F	TM-D	35		42/42	65/65	90/90	130/130		42/42	65/65	90/90	130/130
NSX160N	TM-D	50			65/65	90/90	130/130			65/65	90/90	130/130
NSX160H	TM-D	65				90/90	130/130				90/90	130/130
NSX160S	TM-D	90					130/130					130/130
NSX250B	TM-D	20						30/30	30/30	50/50	50/50	50/50
NSX250F	TM-D	35							42/42	65/65	90/90	130/130
NSX250N	TM-D	50								65/65	90/90	130/130
NSX250H	TM-D	65									90/90	130/130
NSX250S	TM-D	90										130/130
NSX100B	Micrologic	20	30/30	30/30	50/50	50/50	50/50	30/30	30/30	50/50	50/50	50/50
NSX100F	Micrologic	35		42/42	65/65	90/90	130/130		42/42	65/65	90/90	130/130
NSX100N	Micrologic	50			65/65	90/90	130/130			65/65	90/90	130/130
NSX100H	Micrologic	65				90/90	130/130				90/90	130/130
NSX100S	Micrologic	90					130/130					130/130
NSX160B	Micrologic	20	30/30	30/30	50/50	50/50	50/50	30/30	30/30	50/50	50/50	50/50
NSX160F	Micrologic	35		42/42	65/65	90/90	130/130		42/42	65/65	90/90	130/130
NSX160N	Micrologic	50			65/65	90/90	130/130			65/65	90/90	130/130
NSX160H	Micrologic	65				90/90	130/130				90/90	130/130
NSX160S	Micrologic	90					130/130					130/130
NSX250B	Micrologic	20						30/30	30/30	50/50	50/50	50/50
NSX250F	Micrologic	35							42/42	65/65	90/90	130/130
NSX250N	Micrologic	50								65/65	90/90	130/130
NSX250H	Micrologic	65									90/90	130/130
NSX250S	Micrologic	90										130/130

**Note:** respect the basic rules of selectivity, in terms of overload, short-circuit, ground fault and earth leakage when applicable see page A-2, or check curves with Schneider Electric online "Electrical calculation tools".  
**[1]** Applicable for all "Distribution" Micrologic of Compact NSX range: 2.3 4.3, 5.3, 6.3, 7.3. For 4.3 and 7.3 selectivity rules for RCD apply in addition. Applicable for Generators and Service connection (G and AB type) Micrologic of Compact NSX range but curves shall be checked Not applicable for "Motor" Micrologic of Compact NSX range ("M" type).

# Selectivity enhanced by cascading

Upstream: Compact NS800, NS1000, NS1250, NS1600, Micrologic

Downstream: Compact NSX100, NSX160, NSX250, NSX400, NSX630

Ue: 440 V AC

A

Upstream	NS800				NS1000			NS1250		NS1600	
	N	H	L	LB	N	H	L	N	H	N	H
Icu (kA)	50	65	130	200	50	65	130	50	65	50	65
Trip unit	Micrologic										

Downstream		Rating (A)											
		800	800	800	800	1000	1000	1000	1000	1250	1250	1600	1600
	Trip unit	Icu (kA)	Reinforced breaking capacity (kA)										
NSX100B	TM-D / Micrologic	20	50/50	50/50	50/50	50/50	50/50	50/50	50/50	50/50	50/50	50/50	50/50
NSX100F	TM-D / Micrologic	35	50/50	65/65	130/130	130/130	50/50	65/65	130/130	50/50	65/65	50/50	65/65
NSX100N	TM-D / Micrologic	50		65/65	130/130	130/130		65/65	130/130		65/65		65/65
NSX100H	TM-D / Micrologic	65			130/130	130/130			130/130				
NSX100S	TM-D / Micrologic	90			130/130	200/200			130/130				
NSX100L	TM-D / Micrologic	130				200/200							
NSX160B	TM-D / Micrologic	20	50/50	50/50	50/50	50/50	50/50	50/50	50/50	50/50	50/50	50/50	50/50
NSX160F	TM-D / Micrologic	35	50/50	65/65	130/130	130/130	50/50	65/65	130/130	50/50	65/65	50/50	65/65
NSX160N	TM-D / Micrologic	50		65/65	130/130	130/130		65/65	130/130		65/65		65/65
NSX160H	TM-D / Micrologic	65			130/130	130/130			130/130				
NSX160S	TM-D / Micrologic	90			130/130	200/200			130/130				
NSX160L	TM-D / Micrologic	130				200/200							
NSX250B	TM-D / Micrologic	20	50/50	50/50	50/50	50/50	50/50	50/50	50/50	50/50	50/50	50/50	50/50
NSX250F	TM-D / Micrologic	35	50/50	65/65	130/130	130/130	50/50	65/65	130/130	50/50	65/65	50/50	65/65
NSX250N	TM-D / Micrologic	50		65/65	130/130	130/130		65/65	130/130		65/65		65/65
NSX250H	TM-D / Micrologic	65			130/130	130/130			130/130				
NSX250S	TM-D / Micrologic	90			130/130	200/200			130/130				
NSX250L	TM-D / Micrologic	130				200/200							
NSX400F	Micrologic	30	50/50	65/65	10/130	10/130	50/50	65/65	15/130	50/50	65/65	50/50	65/65
NSX400N	Micrologic	42		65/65	10/130	10/130		65/65	15/130		65/65		65/65
NSX400H	Micrologic	65			10/130	10/130			15/130				
NSX400S	Micrologic	90			10/130	10/200			15/130				
NSX400L	Micrologic	130				10/200							
NSX630F	Micrologic	30					50/50	65/65	10/130	50/50	65/65	50/50	65/65
NSX630N	Micrologic	42						65/65	10/130		65/65		65/65
NSX630H	Micrologic	65							10/130				
NSX630S	Micrologic	90							10/130				

**Note:** respect the basic rules of selectivity, in terms of overload, short-circuit, ground fault and earth leakage when applicable see page A-2, or check curves with Schneider Electric online "Electrical calculation tools".

# Selectivity enhanced by cascading

Upstream: Compact NSX160, NSX250, TM-D

Downstream: iC60, C120, NG125

Ue: 220-240 V AC  
(Ph/N 110-130 V AC)



Upstream		NSX160					
		B	F	N	H	S	L
Icu (kA)		40	85	90	100	120	150
Trip unit		TM-D					

Downstream												
Rating (A)			80-100	125-160	80-100	125-160	80-100	125-160	80-100	125-160	80-100	125-160
			Reinforced breaking capacity (kA)									
iC60N		20		30/30		40/40		60/60		60/60		60/60
iC60H		30		40/40		50/50		80/80		80/80		80/80
iC60L	≤ 25	50				65/65		80/80		80/80		80/80
	32-40	36		40/40		65/65		80/80		80/80		80/80
	50-63	30		40/40		65/65		80/80		80/80		80/80
NG125N	≤ 20	50				60/60		70/70		70/70		85/85
	25 to 125	50										85/85
NG125H	≤ 20	70				85/85		85/85		85/85		100/100
	25 to 80	70										100/100

Upstream		NSX250					
		B	F	N	H	S	L
Icu (kA)		40	85	90	100	120	150
Trip unit		TM-D					

Downstream								
Rating (A)			200-250	200-250	200-250	200-250	200-250	200-250
			Reinforced breaking capacity (kA)					
iC60N		20	30/30	40/40	60/60	60/60	60/60	60/60
iC60H		30	40/40	50/50	65/65	65/65	65/65	65/65
iC60L	≤ 25	50		65/65	80/80	80/80	80/80	80/80
	32-40	36	40/40	65/65	80/80	80/80	80/80	80/80
	50-63	30	40/40	40/40	65/65	65/65	65/65	65/65
C120N/H		20/30	40/40	40/40	50/50	50/50	70/70	70/70
NG125N		50		60/60	70/70	70/70	85/85	85/85
NG125H		70		85/85	85/85	85/85	100/100	100/100

**Note:** respect the basic rules of selectivity, in terms of overload, short-circuit, ground fault and earth leakage when applicable see page A-2, or check curves with Schneider Electric online "Electrical calculation tools".

# Selectivity enhanced by cascading

Upstream: Compact NSX100, NSX160, NSX250, Micrologic

Downstream: iC60, C120, NG125



Ue: 220-240 V AC  
(Ph/N 110-130 V AC)

Upstream		NSX100					
		B	F	N	H	S	L
Icu (kA)		40	85	90	100	120	150
Trip unit		Micrologic [1]					

Downstream		Rating (A)												
		40	100	40	100	40	100	40	100	40	100	40	100	
		Reinforced breaking capacity (kA)												
iC60N	Rating (A)													
	Icu (kA)													
	≤ 25	20	40/40	40/40	40/40	40/40	60/60	60/60	60/60	60/60	60/60	60/60	60/60	60/60
	32-40	20	40/40		40/40		60/60		60/60		60/60		60/60	
	50-63	20												
iC60H	Rating (A)													
	Icu (kA)													
	≤ 25	30	40/40	40/40	50/50	50/50	80/80	80/80	80/80	80/80	80/80	80/80	80/80	80/80
	32-40	30		40/40		50/50		80/80		80/80		80/80		80/80
	50-63	30												
iC60L	Rating (A)													
	Icu (kA)													
	≤ 25	50			65/65	65/65	80/80	80/80	80/80	80/80	80/80	80/80	80/80	80/80
	32-40	36			65/65		80/80		80/80		80/80		80/80	
	50-63	30												

Upstream		NSX160					
		B	F	N	H	S	L
Icu (kA)		40	85	90	100	120	150
Trip unit		Micrologic [1]					

Downstream		Rating (A)											
		80	160	80	160	80	160	80	160	80	160	80	160
		Reinforced breaking capacity (kA)											
iC60N	Rating (A)												
	Icu (kA)												
	≤ 50	20	40/40	40/40	40/40	40/40	60/60	60/60	60/60	60/60	60/60	60/60	60/60
	63	20	40/40		40/40		60/60		60/60		60/60		60/60
iC60H	Rating (A)												
	Icu (kA)												
	≤ 50	30	40/40	40/40	50/50	50/50	80/80	80/80	80/80	80/80	80/80	80/80	80/80
	63	30	40/40		50/50		80/80		80/80		80/80		80/80
iC60L	Rating (A)												
	Icu (kA)												
	≤ 40	36			65/65	65/65	80/80	80/80	80/80	80/80	80/80	80/80	80/80
	50	30	40/40	40/40	65/65	65/65	80/80	80/80	80/80	80/80	80/80	80/80	80/80
	63	30	40/40		65/65		80/80		80/80		80/80		80/80

Upstream		NSX250					
		B	F	N	H	S	L
Icu (kA)		40	85	90	100	120	150
Trip unit		Micrologic [1]					

Downstream		Rating (A)					
		250	250	250	250	250	250
		Reinforced breaking capacity (kA)					
iC60N	Rating (A)						
	Icu (kA)						
	20	40/40	40/40	60/60	60/60	60/60	60/60
iC60H	Rating (A)						
	Icu (kA)						
	30	40/40	50/50	65/65	65/65	65/65	65/65
iC60L	Rating (A)						
	Icu (kA)						
	≤ 25	50		65/65	80/80	80/80	80/80
	32-40	36		65/65	80/80	80/80	80/80
	50-63	30	40/40	65/65	65/65	65/65	65/65
C120N/H	Rating (A)	20/30	40/40	40/40	50/50	50/50	70/70
NG125N	Rating (A)	50		60/60	70/70	70/70	85/85
NG125H	Rating (A)	70		85/85	85/85	85/85	100/100

**Note:** respect the basic rules of selectivity, in terms of overload, short-circuit, ground fault and earth leakage when applicable see page A-2, or check curves with Schneider Electric online "Electrical calculation tools".  
**[1]** Applicable for all "Distribution" Micrologic of Compact NSX range: 2.2 4.2, 5.2, 6.2, 7.2. For 4.2 and 7.2 selectivity rules for RCD apply in addition. Applicable for Generators and Service connection (G and AB type) Micrologic of Compact NSX range but curves shall be checked. Not applicable for "Motor" Micrologic of Compact NSX range ("M" type).

# Selectivity enhanced by cascading

Upstream: Compact NSX250, TM-D, Micrologic

Downstream: Compact NSXm, NSX100

Ue: 220-240 V AC  
(Ph/N 110-130 V AC)



Upstream		NSX250					
		B	F	N	H	S	L
Icu (kA)		40	85	90	100	120	150
Trip unit		TM-D					

Downstream			Reinforced breaking capacity (kA)					
Rating (A)	Rating (A)	Icu (kA)	200-250	200-250	200-250	200-250	200-250	200-250
NSXm E	≤ 25	25	40/40	85/85	85/85	85/85	85/85	85/85
NSXm B	≤ 25	50		85/85	90/90	100/100	100/100	100/100
NSXm F	≤ 25	85			90/90	100/100	100/100	100/100
NSXm N	≤ 25	90				100/100	100/100	100/100
NSX100 B	≤ 25	40		85/85	90/90	100/100	100/100	100/100
TM-D	40 - 100			36/85	36/90	36/100	36/100	36/100
NSX100F	≤ 25	85			90/90	100/100	120/120	150/150
TM-D	40 - 100				36/90	36/100	36/120	36/150
NSX100N	≤ 25	90				100/100	120/120	150/150
TM-D	40 - 100					36/100	36/120	36/150
NSX100H	≤ 25	100					120/120	150/150
TM-D	40 - 100						36/120	36/150
NSX100S	≤ 25	120						150/150
TM-D	40 - 100							36/150
NSX100 B	≤ 25	40		2/85	2/90	2/100	2/100	2/100
Micrologic	≤ 25							
NSX100 F	≤ 25	85			2/90	2/100	2/120	2/150
Micrologic	≤ 25							
NSX100 N	≤ 25	90				2/100	2/120	2/150
Micrologic	≤ 25							
NSX100 H	≤ 25	100					2/120	2/150
Micrologic	≤ 25							
NSX100 S	≤ 25	120						2/150
Micrologic	≤ 25							

Upstream		NSX250					
		B	F	N	H	S	L
Icu (kA)		40	85	90	100	120	150
Trip unit		Micrologic [1]					

Downstream			Reinforced breaking capacity (kA)					
Rating (A)	Rating (A)	Icu (kA)	200-250	200-250	200-250	200-250	200-250	200-250
NSXm E	≤ 125	25	40/40	85/85	85/85	85/85	85/85	85/85
NSXm B	≤ 125	50		85/85	90/90	100/100	100/100	100/100
NSXm F	≤ 125	85			90/90	100/100	100/100	100/100
NSXm N	≤ 125	90				100/100	100/100	100/100
NSX100B	≤ 25	40		85/85	90/90	100/100	100/100	100/100
TM-D	40-100			36/85	36/90	36/100	36/100	36/100
NSX100F	≤ 25	85			90/90	100/100	120/120	150/150
TM-D	40-100				36/90	36/100	36/120	36/150
NSX100N	≤ 25	90				100/100	120/120	150/150
TM-D	40-100					36/100	36/120	36/150
NSX100H	≤ 25	100					120/120	150/150
TM-D	40-100						36/120	36/150
NSX100S	≤ 25	120						150/150
TM-D	40-100							36/150
NSX100B	≤ 25	40		36/85	36/90	36/100	36/100	36/100
Micrologic	≤ 25							
NSX100F	≤ 25	85			36/90	36/100	36/120	36/150
Micrologic	≤ 25							
NSX100N	≤ 25	90				36/100	36/120	36/150
Micrologic	≤ 25							
NSX100H	≤ 25	100					36/120	36/150
Micrologic	≤ 25							
NSX100S	≤ 25	120						36/150
Micrologic	≤ 25							

Note: respect the basic rules of selectivity, in terms of overload, short-circuit, ground fault and earth leakage when applicable see page A-2, or check curves with Schneider Electric online "Electrical calculation tools".

[1] Applicable for all "Distribution" Micrologic of Compact NSX range: 2.2 4.2, 5.2, 6.2, 7.2. For 4.2 and 7.2 selectivity rules for RCD apply in addition. Applicable for Generators and Service connection (G and AB type) Micrologic of Compact NSX range but curves shall be checked. Not applicable for "Motor" Micrologic of Compact NSX range ("M" type).

# Selectivity enhanced by Cascading

Upstream: Compact NSX400, NSX630, NS800L, NS800LB, NS1000L, Micrologic

Downstream: Compact NSX100, NSX160, NSX250, NSX400, NSX630



Ue: 220-240 V AC  
(Ph/N 110-130 V AC)

Upstream	NSX400				NSX630				NS800		NS1000
	N	H	S	L	N	H	S	L	L	LB	L
Icu (kA)	85	100	120	150	85	100	120	150	150	200	150
Trip unit	Micrologic [1]										

Downstream			400	400	400	400	630	630	630	630	800	1000	
Rating (A)	Trip unit	Icu (kA)	Reinforced breaking capacity (kA)										
NSX100B	TM-D	40	85/85	90/90	100/100	100/100	85/85	90/90	100/100	100/100	50/50	50/50	50/50
NSX100F	TM-D	85		90/90	120/120	150/150		90/90	120/120	150/150	150/150	150/150	150/150
NSX100N	TM-D	90		100/100	120/120	150/150		100/100	120/120	150/150	150/150	150/150	150/150
NSX100H	TM-D	100			120/120	150/150			120/120	150/150	150/150	150/150	150/150
NSX100S	TM-D	120				150/150				150/150	150/150	200/200	150/150
NSX100L	TM-D	150										200/200	
NSX160B	TM-D	40	85/85	90/90	100/100	100/100	85/85	90/90	100/100	100/100	50/50	50/50	50/50
NSX160F	TM-D	85		90/90	120/120	150/150		90/90	120/120	150/150	150/150	150/150	150/150
NSX160N	TM-D	90		100/100	120/120	150/150		100/100	120/120	150/150	150/150	150/150	150/150
NSX160H	TM-D	100			120/120	150/150			120/120	150/150	150/150	150/150	150/150
NSX160S	TM-D	120				150/150				150/150	150/150	200/200	150/150
NSX160L	TM-D	150										200/200	
NSX250B	TM-D	40					85/85	90/90	100/100	100/100	50/50	50/50	50/50
NSX250F	TM-D	85						90/90	120/120	150/150	150/150	150/150	150/150
NSX250N	TM-D	90						100/100	120/120	150/150	150/150	150/150	150/150
NSX250H	TM-D	100							120/120	150/150	150/150	150/150	150/150
NSX250S	TM-D	120								150/150	150/150	200/200	150/150
NSX250L	TM-D	150										200/200	
NSX100B	Micrologic	40	85/85	90/90	100/100	100/100	85/85	90/90	100/100	100/100	50/50	50/50	50/50
NSX100F	Micrologic	85		90/90	120/120	150/150		90/90	120/120	150/150	150/150	150/150	150/150
NSX100N	Micrologic	90		100/100	120/120	150/150		100/100	120/120	150/150	150/150	150/150	150/150
NSX100H	Micrologic	100			120/120	150/150			120/120	150/150	150/150	150/150	150/150
NSX100S	Micrologic	120				150/150				150/150	150/150	200/200	150/150
NSX100L	Micrologic	150										200/200	
NSX160B	Micrologic	40	85/85	90/90	100/100	100/100	85/85	90/90	100/100	100/100	50/50	50/50	50/50
NSX160F	Micrologic	85		90/90	120/120	150/150		90/90	120/120	150/150	150/150	150/150	150/150
NSX160N	Micrologic	90		100/100	120/120	150/150		100/100	120/120	150/150	150/150	150/150	150/150
NSX160H	Micrologic	100			120/120	150/150			120/120	150/150	150/150	150/150	150/150
NSX160S	Micrologic	120				150/150				150/150	150/150	200/200	150/150
NSX160L	Micrologic	150										200/200	
NSX250B	Micrologic	40					85/85	90/90	100/100	100/100	50/50	50/50	50/50
NSX250F	Micrologic	85						90/90	120/120	150/150	150/150	150/150	150/150
NSX250N	Micrologic	90						100/100	120/120	150/150	150/150	150/150	150/150
NSX250H	Micrologic	100							120/120	150/150	150/150	150/150	150/150
NSX250S	Micrologic	120								150/150	150/150	200/200	150/150
NSX250L	Micrologic	150										200/200	
NSX400F	Micrologic	40									10/150	10/150	15/150
NSX400N	Micrologic	85									10/150	10/150	15/150
NSX400H	Micrologic	100									10/150	10/150	15/150
NSX400S	Micrologic	120									10/150	10/200	15/150
NSX400L	Micrologic	150										10/200	
NSX630F	Micrologic	40											10/150
NSX630N	Micrologic	85											10/150
NSX630H	Micrologic	100											10/150
NSX630S	Micrologic	120											10/150

**Note:** respect the basic rules of selectivity, in terms of overload, short-circuit, ground fault and earth leakage when applicable see page A-2, or check curves with Schneider Electric online "Electrical calculation tools".

[1] Applicable for all "Distribution" Micrologic of Compact NSX range: 2.3 4.3, 5.3, 6.3, 7.3. For 4.3 and 7.3 selectivity rules for RCD apply in addition. Applicable for Generators and Service connection (G and AB type) Micrologic of Compact NSX range but curves shall be checked Not applicable for "Motor" Micrologic of Compact NSX range ("M" type).

# Motor protection selectivity

## Motor protection selectivity tables

See introduction page A7 for condition of use of selectivity tables.

Upstream	Compact							
	NSXm	NSX				NS		
	16-160	100-250	100 -160	250	400-630	630b-1600	630b-1000	1600-3200
	All breaking capacities					N/H	L	N
Downstream	TM-D & Micrologic 4.1	TMD	Micrologic			Micrologic		
	Tesys GV2 ME01...ME32	page B-3	page B-5	page B-7	page B-9	page B-9	page B-11	page B-12
Tesys GV2 P01...P32								
Tesys U LUB12 + LUC●6...12								
Tesys U LUB32 + LUC●6...32								
Tesys GV3 P13...P65								
Tesys GV4 P/PE/PEM 02-115								
Compact NSX100 F/N/H/S/L/R Micrologic 2.2M 6.2M								
Compact NSX160 F/N/H/S/L Micrologic 2.2M 6.2M								
Compact NSX250 F/N/H/S/L/R Micrologic 2.2M 6.2M								
Compact NSX400F/N/H/S/L/R Micrologic 2.3 6.3M 320								
Compact NSX630F/N/H/S/L/R Micrologic 2.3M 6.3M								
iC60 L MA1.6...MA40 + LRD	page B-10	page B-6	page B-8	page B-10	page B-10	page B-11	page B-12	page B-13
NG125L MA2.5...MA63 + LRD								
Tesys GV2 L03...L32 + LRD								
Tesys GV3 L25...L65 + LRD								
Tesys GV4 L/LE 02-115 +LRD								
Compact NSX100F/N/H/S/L MA 2.5...MA6.3 + LRD								
Compact NSX100F/N/H/S/L/R MA12.5...MA100 + LRD								
Compact NSX160F/N/H/S/L MA150 + LR9D/F								
Compact NSX250F/N/H/S/L/R MA220+LR9D/F								
Compact NSX400F/N/H/S/L/R 1.3M +LR9F								
Compact NSX630 F/N/H/S/L/R 1.3M +LR9F								



# Motor protection selectivity

B

Upstream	Masterpact						
	MTZ1		MTZ2			MTZ3	
	06-16	06-10	08-20	25-40	25-40	40-63	40-63
H1/H2/H3	L1	N1/H1/H2/L1	H1/H2	H3	H1	H2	
Downstream	Micrologic		Micrologic			Micrologic	
Tesys GV2 ME01...ME32							
Tesys GV2 P01...P32							
Tesys U LUB12 + LUC●6...12							
Tesys U LUB32 + LUC●6...32							
Tesys GV3 P13...P65							
Tesys GV4 P/PE/PEM 02-115							
Compact NSX100 F/N/H/S/L/R Micrologic 2.2M 6.2M							
Compact NSX160 F/N/H/S/L Micrologic 2.2M 6.2M							
Compact NSX250 F/N/H/S/L/R Micrologic 2.2M 6.2M							
Compact NSX400F/N/H/S/L/R Micrologic 2.3 6.3M 320							
Compact NSX630F/N/H/S/L/R Micrologic 2.3M 6.3M	page B-14	page B-15	page B-16	page B-17	page B-18	page B-17	page B-18
iC60 L MA1.6...MA40 + LRD							
NG125L MA2.5...MA63 + LRD							
GV2 L03...L32 + LRD							
GV3 L25...L65 + LRD							
GV4 L/LE 02-115 +LRD							
Compact NSX100F/N/H/S/L MA 2.5...MA6.3 + LRD							
Compact NSX100F/N/H/S/L/R MA12.5...MA100 + LRD							
Compact NSX160F/N/H/S/L MA150 + LR9D/F							
Compact NSX250F/N/H/S/L/R MA220+LR9D/F							
Compact NSX400F/N/H/S/L/R 1.3M +LR9F							
Compact NSX630 F/N/H/S/L/R 1.3M +LR9F							

## Motor protection cascading tables

380...415 V AC	page B-19
440 V AC	page B-20
220...240 V AC	page B-21

## Motor protection selectivity enhanced by cascading tables

380...415 V AC	page B-22-B-25
440 V AC	page B-26

## Protection of motor circuits with circuit-breakers

Introduction	B-27
Using the coordination tables	
Type 2 coordination tables with circuit-breaker	B-36
Type 1 coordination tables with circuit-breaker	B-52

## Type 1 coordination table for AC1 Utilisation category

Non-inductive or slightly inductive loads	B-60
---	------

## Protection of motor circuits with fuses:

Introduction	page B-61
Type 2 coordination tables with fuses	page B-67



# Motor protection selectivity

Upstream: Compact NSXm TM-D, Micrologic 4.1

Downstream: GV2ME/P, GV3P, GV4P/PE/PEM, LUB12, LUB32

U<sub>e</sub> ≤ 440 V AC

Upstream			NSXm E/B/F/N/H										NSXm E/B/F/N/H				
Trip unit			TM-D										Micrologic 4.1				
Downstream			Rating (A)	16	25	32	40	50	63	80	100	125	160	25	50	100	160
			Setting (Ir)	16	25	32	40	50	63	80	100	125	160	23	50	100	160
			Setting range	Selectivity limit (kA)													
	Trip unit or rating	Th Relay															
GV2 ME/P	01	Integrated	0.1/0.16	T	T	T	T	T	T	T	T	T	T	T	T	T	T
GV2 ME/P	02	Integrated	0.16/0.25	T	T	T	T	T	T	T	T	T	T	T	T	T	T
GV2 ME/P	03	Integrated	0.25/0.40	T	T	T	T	T	T	T	T	T	T	T	T	T	T
GV2 ME/P	04	Integrated	0.40/0.63	T	T	T	T	T	T	T	T	T	T	T	T	T	T
GV2 ME/P	05	Integrated	0.63/1	T	T	T	T	T	T	T	T	T	T	T	T	T	T
GV2 ME/P	06	Integrated	1/1.6	0.5	T	T	T	T	T	T	T	T	T	0.38	0.75	T	T
GV2 ME/P	07	Integrated	1.6/2.5	0.5	0.5	0.5	T	T	T	T	T	T	T	0.38	0.75	T	T
GV2 ME/P	08	Integrated	2.5/4	0.5	0.5	0.5	0.5	0.6	0.8	T	T	T	T	0.38	0.75	T	T
GV2 ME/P	10	Integrated	4/6.3		0.5	0.5	0.5	0.6	0.8	T	T	T	T	0.38	0.75	T	T
GV2 ME/P	14	Integrated	06/10			0.5	0.5	0.6	0.8	8	8	10	10	0.38	0.75	T	T
GV2 ME/P	16	Integrated	9/14					0.6	0.8	5	5	8	8		0.75	T	T
GV2 ME/P	20	Integrated	13/18						0.8	4	4	7	7			T	T
GV2 ME/P	21	Integrated	17/23						0.8	3	3	3	3			T	T
GV2 ME/P	22	Integrated	20/25							3	3	3	3			T	T
GV2 ME/P	32	Integrated	24/32								2	2	2			1.5	T
GV3 P	13	Integrated	01/13					0.6	0.8	4	4	5	6		0.75	1.5	T
GV3 P	18	Integrated	12/18						0.8	3	3	4	4			1.5	30
GV3 P	25	Integrated	17/25							2	2	3	3			1.5	10
GV3 P	32	Integrated	23/32								1	1.2	1.25				10
GV3 P	40	Integrated	30/40									1.25	1.25				10
GV3 P	50	Integrated	37/50										1.25				10
GV3 P	65	Integrated	48/65														
GV4P/PE/PEM	02	Integrated	0.8/2	0.5	0.5	0.5	0.5	0.6	T	T	T	T	T	0.38	T	T	T
GV4P/PE/PEM	03	Integrated	1.4/3.5	0.5	0.5	0.5	0.5	0.6	5	T	T	T	T	0.38	3	3.5	T
GV4P/PE/PEM	07	Integrated	2.9/7		0.5	0.5	0.5	0.6	0.8	3	4	4	4	0.38	2	2	4
GV4P/PE/PEM	12	Integrated	5/12.5					0.6	0.8	1	1	3	3		0.75	1.5	2.4
GV4P/PE/PEM	25	Integrated	10/25							1	1	1.25	1.25			1.5	2.4
GV4P/PE/PEM	50	Integrated	20/50										1.25				2.4
GV4P/PE/PEM	80	Integrated	40/80														
GV4P/PE/PEM	115	Integrated	65/115														
LUB12		LUC●X6	0.15/0.6	0.5	0.5	0.5	0.5	0.6	0.8	36	36	36	36	0.25	0.75	1.5	36
LUB12		LUC●1X	0.35...1.4	0.5	0.5	0.5	0.5	0.6	0.8	36	36	36	36	0.25	0.75	1.5	36
LUB12		LUC●05	1.25...5	0.5	0.5	0.5	0.5	0.6	0.8	36	36	36	36	0.25	0.75	1.5	36
LUB12		LUC●12	3...12	0.5	0.5	0.5	0.5	0.6	0.8	36	36	36	36	0.25	0.75	1.5	36
LUB32		LUC●X6	0.15...0.6	0.5	0.5	0.5	0.5	0.6	0.8	1	1	1.25	1.25	0.25	0.75	1.5	20
LUB32		LUC●1X	0.35...1.4	0.5	0.5	0.5	0.5	0.6	0.8	1	1	1.25	1.25	0.25	0.75	1.5	20
LUB32		LUC●05	1.25...5	0.5	0.5	0.5	0.5	0.6	0.8	1	1	1.25	1.25	0.25	0.75	1.5	20
LUB32		LUC●12	3...12			0.5	0.5	0.6	0.8	1	1	1.25	1.25		0.75	1.5	20
LUB32		LUC●18	4.5...18						0.8	1	1	1.25	1.25			1.5	20
LUB32		LUC●32	8...32								1	1.25	1.25			1.5	20

**T** Total selectivity, up to the breaking capacity of the downstream circuit breaker.

**4** Selectivity limit = 4 kA.

No selectivity.



# Motor protection selectivity

Upstream: Compact NSXm TM-D, Micrologic 4.1

Downstream: iC60L MA, NG125L MA, GV2L/LE, GV3L, GV4L/LE

U<sub>e</sub> ≤ 440 V AC

Upstream			NSXm E/B/F/N/H										NSXm E/B/F/N/H				
Trip unit			TM-D										Micrologic 4.1				
Downstream			Rating (A)	16	25	32	40	50	63	80	100	125	160	25	50	100	160
			Setting (I <sub>r</sub> )	16	25	32	40	50	63	80	100	125	160	25	50	100	160
			Setting range	Selectivity limit (kA)													
	Trip unit or rating	Th Relay															
iC60L MA	1.6	LRD6	1/1.6	0.5	T	T	T	T	T	T	T	T	T	5	5	T	T
iC60L MA	2.5	LRD7	1.6/2.5	0.5	0.5	0.5	T	T	T	T	T	T	T	0.375	0.75	T	T
iC60L MA	4	LRD8	2.5/4	0.5	0.5	0.5	0.5	0.6	0.8	T	T	T	T	0.375	0.75	T	T
iC60L MA	6.3	LRD10	4/6.3		0.5	0.5	0.5	0.6	0.8	1	1	1.25	1.25	0.38	0.75	1.5	T
iC60L MA	10	LRD12	5.5/8		0.5	0.5	0.5	0.6	0.8	1	1	1.25	1.25	0.38	0.75	1.5	T
iC60L MA	10	LRD14	07/10			0.5	0.5	0.6	0.8	1	1	1.25	1.25		0.75	1.5	T
iC60L MA	12.5	LRD16	9/13				0.5	0.6	0.8	1	1	1.25	1.25		0.75	1.5	T
iC60L MA	16	LRD21	12/18					0.6	0.8	1	1	1.25	1.25			1.5	T
iC60L MA	25	LRD22	17/25							1	1	1.25	1.25			1.5	T
iC60L MA	40	LRD32	23/32								1	1.25	1.25			1.5	T
iC60L MA	40	LRD3355	30/40									1.25	1.25				T
NG125L MA	40	LRD32	23/32								1	1.25	1.25			1.5	T
NG125L MA	40	LRD3355	30/40									1.25	1.25				T
NG125L MA	63	LRD3357	37/50										1.25				T
NG125L MA	63	LRD3359	48/65										1.25				T
GV2 L/LE	03	LRD3	0.25/0.40	T	T	T	T	T	T	T	T	T	T	T	T	T	T
GV2 L/LE	04	LRD4	0.40/0.63	T	T	T	T	T	T	T	T	T	T	T	T	T	T
GV2 L/LE	05	LRD5	0.63/1	T	T	T	T	T	T	T	T	T	T	T	T	T	T
GV2 L/LE	06	LRD6	1/1.6	0.5	T	T	T	T	T	T	T	T	T	0.38	0.75	T	T
GV2 L/LE	07	LRD7	1.6/2.5	0.5	0.5	0.5	T	T	T	T	T	T	T	0.38	0.75	T	T
GV2 L/LE	08	LRD8	2.5/4	0.5	0.5	0.5	0.5	0.6	0.8	T	T	T	T	0.38	0.75	T	T
GV2 L/LE	10	LRD10	4/6.3		0.5	0.5	0.5	0.6	0.8	T	T	T	T	0.38	0.75	T	T
GV2 L/LE	14	LRD14	07/10			0.5	0.5	0.6	0.8	10	10	T	T	0.38	0.75	T	T
GV2 L/LE	16	LRD16	9/13					0.6	0.8	7	7	10	10		0.75	T	T
GV2 L/LE	20	LRD21	12/18						0.8	5	5	8	8			T	T
GV2 L/LE	22	LRD22	17/25							3	3	3	3			T	T
GV2 L/LE	32	LRD32	23/32								2	2	2			1.5	T
GV3 L	25	LRD22	20/25							2	2	3	3			1.5	10
GV3 L	32	LRD32	23/32								1	1.2	1.25			1.5	10
GV3 L	40	LRD340	30/40									1.25	1.25				10
GV3 L	50	LRD350	37/50										1.25				10
GV3 L	65	LRD365	48/65														
GV4 L/LE	02	LRD-07	1.6/2.5	0.5	0.5	0.5	0.5	0.6	T	T	T	T	T	0.38	T	T	T
GV4 L/LE	03	LRD-08	2.5/4	0.5	0.5	0.5	0.5	0.6	5	T	T	T	T	0.38	3	3.5	T
GV4 L/LE	07	LRD-12	5.5/8		0.5	0.5	0.5	0.6	0.8	3	4	4	4	0.38	2	2	4
GV4 L/LE	12	LRD-313	9/13					0.6	0.8	1	1	3	3			1.5	2.4
GV4 L/LE	25	LRD-325	17/25							1	1	1.25	1.25			1.5	2.4
GV4 L/LE	50	LRD-350	37/50										1.25				2.4
GV4 L/LE	80	LRD-33 63	63/80														
GV4 L/LE	115	LR9D-5369 or LR9-F5369	90/150														

- T Total selectivity, up to the breaking capacity of the downstream circuit breaker.
- 4 Selectivity limit = 4 kA.
- No selectivity.

# Motor protection selectivity

Upstream: Compact NSX100 to 250 TM-D

Downstream: GV2, GV3, GV4, LUB12, LUB32, Integral 63, Compact NSX100 to 250  
 $U_e \leq 440 \text{ V AC}$

Upstream			NSX100B/F/N/H/S/L/R								NSX160B/F/N/H/S/L				NSX250B/F/N/H/S/L/R				
Trip unit			TM-D																
Downstream			Rating (A)	16	25	32	40	50	63	80	100	80	100	125	160	160	200	250	
			Setting (Ir)	16	25	32	40	50	63	80	100	80	100	125	160	160	200	250	
			Setting range	Selectivity limit (kA)															
	Trip unit or rating	Th Relay																	
GV2 ME/P	01	Integrated	0.1/0.16	T	T	T	T	T	T	T	T	T	T	T	T	T	T	T	
GV2 ME/P	02	Integrated	0.16/0.25	T	T	T	T	T	T	T	T	T	T	T	T	T	T	T	
GV2 ME/P	03	Integrated	0.25/0.40	T	T	T	T	T	T	T	T	T	T	T	T	T	T	T	
GV2 ME/P	04	Integrated	0.40/0.63	T	T	T	T	T	T	T	T	T	T	T	T	T	T	T	
GV2 ME/P	05	Integrated	0.63/1	T	T	T	T	T	T	T	T	T	T	T	T	T	T	T	
GV2 ME/P	06	Integrated	1/1.6	0.19	T	T	T	T	T	T	T	T	T	T	T	T	T	T	
GV2 ME/P	07	Integrated	1.6/2.5	0.19	0.25	0.4	T	T	T	T	T	T	T	T	T	T	T	T	
GV2 ME/P	08	Integrated	2.5/4	0.19	0.25	0.4	0.5	0.5	0.5	0.63	0.8	0.63	0.8	T	T	T	T	T	
GV2 ME/P	10	Integrated	4/6.3		0.25	0.4	0.5	0.5	0.5	0.63	0.8	0.63	0.8	T	T	T	T	T	
GV2 ME/P	14	Integrated	06/10			0.4	0.5	0.5	0.5	0.63	0.8	0.63	0.8	T	T	T	T	T	
GV2 ME/P	16	Integrated	9/14					0.5	0.5	0.63	0.8	0.63	0.8	T	T	T	T	T	
GV2 ME/P	20	Integrated	13/18							0.63	0.8	0.63	0.8	T	T	T	T	T	
GV2 ME/P	21	Integrated	17/23							0.63	0.8	0.63	0.8	T	T	T	T	T	
GV2 ME/P	22	Integrated	20/25							0.63	0.8	0.63	0.8	T	T	T	T	T	
GV2 ME/P	32	Integrated	24/32							0.63	0.8	0.63	0.8	T	T	T	T	T	
GV3 P	13	Integrated	01/13				0.5	0.5	0.5	0.63	0.8	0.63	0.8	1.25	1.25	1.25	T	T	
GV3 P	18	Integrated	12/18					0.5	0.5	0.63	0.8	0.63	0.8	1.25	1.25	1.25	T	T	
GV3 P	25	Integrated	17/25						0.5	0.63	0.8	0.63	0.8	1.25	1.25	1.25	T	T	
GV3 P	32	Integrated	23/32							0.63	0.8	0.63	0.8	1.25	1.25	1.25	T	T	
GV3 P	40	Integrated	30/40											1.25	1.25	1.25	T	T	
GV3 P	50	Integrated	37/50											1.25	1.25	1.25	T	T	
GV3 P	65	Integrated	48/65												1.25	1.25	T	T	
GV4P/PE/PEM	02	Integrated	0.8/2	0.19	0.25	0.4	0.5	0.5	0.5	0.63	0.8	0.63	0.8	1.25	1.25	1.25	T	T	
GV4P/PE/PEM	03	Integrated	1.4/3.5		0.25	0.4	0.5	0.5	0.5	0.63	0.8	0.63	0.8	1.25	1.25	1.25	T	T	
GV4P/PE/PEM	07	Integrated	2.9/7		0.25	0.4	0.5	0.5	0.5	0.63	0.8	0.63	0.8	1.25	1.25	1.25	T	T	
GV4P/PE/PEM	12	Integrated	5/12.5				0.5	0.5	0.5	0.63	0.8	0.63	0.8	1.25	1.25	1.25	T	T	
GV4P/PE/PEM	25	Integrated	10/25							0.63	0.8	0.63	0.8	1.25	1.25	1.25	T	T	
GV4P/PE/PEM	50	Integrated	20/50											1.25	1.25	1.25	T	T	
GV4P/PE/PEM	80	Integrated	40/80												1.25	1.25	T	T	
GV4P/PE/PEM	115	Integrated	65/115														T	T	
LUB12		LUC●X6	0.15/0.6	0.19	0.3	0.4	0.5	0.5	0.5	0.63	0.8	0.63	0.8	T	T	T	T	T	
LUB12		LUC●1X	0.35...1.4	0.19	0.3	0.4	0.5	0.5	0.5	0.63	0.8	0.63	0.8	T	T	T	T	T	
LUB12		LUC●05	1.25...5	0.19	0.3	0.4	0.5	0.5	0.5	0.63	0.8	0.63	0.8	T	T	T	T	T	
LUB12		LUC●12	3...12				0.5	0.5	0.5	0.63	0.8	0.63	0.8	T	T	T	T	T	
LUB32		LUC●X6	0.15...0.6	0.19	0.3	0.4	0.5	0.5	0.5	0.63	0.8	0.63	0.8	5	5	5	T	T	
LUB32		LUC●1X	0.35...1.4	0.19	0.3	0.4	0.5	0.5	0.5	0.63	0.8	0.63	0.8	5	5	5	T	T	
LUB32		LUC●05	1.25...5	0.19	0.3	0.4	0.5	0.5	0.5	0.63	0.8	0.63	0.8	5	5	5	T	T	
LUB32		LUC●12	3...12				0.5	0.5	0.5	0.63	0.8	0.63	0.8	5	5	5	T	T	
LUB32		LUC●18	4.5...18						0.5	0.63	0.8	0.63	0.8	5	5	5	T	T	
LUB32		LUC●32	8...32							0.8	0.8	0.8	0.8	5	5	5	T	T	
Integral 63		LB1-LD03M16	1/13				0.5	0.5	0.5	0.63	0.8	0.63	0.8	1	1	1	T	T	
Integral 63		LB1-LD03M21	13/18						0.5	0.63	0.8	0.63	0.8	1	1	1	T	T	
Integral 63		LB1-LD03M22	18/25							0.63	0.8	0.63	0.8	1	1	1	T	T	
Integral 63		LB1-LD03M53	23/32								0.8	0.8	0.8	1	1	1	T	T	
Integral 63		LB1-LD03M55	28/40											1	1	1	T	T	
Integral 63		LB1-LD03M57	35/50												1	1	T	T	
NSX100 F/N/H/S/L/R		Mic. 2.2M or 6.2EM	25/50										0.8	0.8	1	1	1	36	36
			100															36	
NSX160 F/N/H/S/L/R		Mic. 2.2M or 6.2EM	100											1	1	1	2	2.5	
			150															2.5	
NSX250 F/N/H/S/L/R		Mic. 2.2M or 6.2EM	150											1	1	1	2	2.5	
			220															2.5	

- T Total selectivity, up to the breaking capacity of the downstream circuit breaker.
- 4 Selectivity limit = 4 kA.
- No selectivity.

**Note:** respect the basic rules of selectivity, in terms of overload, short-circuit, ground fault and earth leakage when applicable see page A-2, or check curves with Schneider Electric online "Electrical calculation tools".

# Motor protection selectivity

Upstream: Compact NSX100 to 250 TM-D

Downstream: iC60L MA, NG125L MA, GV2, GV3, GV4, Compact NSX100

U<sub>e</sub> ≤ 440 V AC

Upstream			NSX100B/F/N/H/S/L/R							NSX160B/F/N/H/S/L				NSX250B/F/N/H/S/L/R				
Trip unit			TM-D															
Downstream			Rating (A)	16	25	32	40	50	63	80	100	80	100	125	160	160	200	250
CB	Rating	Th Relay	Setting (Ir)	16	25	32	40	50	63	80	100	80	100	125	160	160	200	250
			Setting range	Selectivity limit (kA)														
iC60L MA	1.6	LRD6	1/1.6	0.19	T	T	T	T	T	T	T	T	T	T	T	T	T	T
iC60L MA	2.5	LRD7	1.6/2.5	0.19	0.3	0.4	T	T	T	T	T	T	T	T	T	T	T	T
iC60L MA	4	LRD8	2.5/4	0.19	0.3	0.4	0.5	0.5	0.5	0.63	T	0.63	T	T	T	T	T	T
iC60L MA	6.3	LRD10	4/6.3		0.3	0.4	0.5	0.5	0.5	0.63	5	0.63	5	T	T	T	T	T
iC60L MA	10	LRD12	5.5/8		0.3	0.4	0.5	0.5	0.5	0.63	2	0.63	2	T	T	T	T	T
iC60L MA	10	LRD14	07/10			0.4	0.5	0.5	0.5	0.63	0.8	0.63	0.8	T	T	T	T	T
iC60L MA	12.5	LRD16	9/13				0.5	0.5	0.5	0.63	0.8	0.63	0.8	T	T	T	T	T
iC60L MA	16	LRD21	12/18						0.5	0.63	0.8	0.63	0.8	T	T	T	T	T
iC60L MA	25	LRD22	17/25							0.63	0.8	0.63	0.8	T	T	T	T	T
iC60L MA	40	LRD32	23/32								0.8	0.8	0.8	T	T	T	T	T
iC60L MA	40	LRD3355	30/40										0.8	T	T	T	T	T
NG125L MA	1.6	LRD6	1/1.6	0.19	T	T	T	T	T	T	T	T	T	T	T	T	T	T
NG125L MA	2.5	LRD7	1.6/2.5	0.19	0.3	0.4	T	T	T	T	T	T	T	T	T	T	T	T
NG125L MA	4	LRD8	2.5/4	0.19	0.3	0.4	0.5	0.5	0.5	0.63	T	0.63	T	T	T	T	T	T
NG125L MA	6.3	LRD10	4/6.3		0.3	0.4	0.5	0.5	0.5	0.63	5	0.63	5	T	T	T	T	T
NG125L MA	10	LRD12	5.5/8		0.3	0.4	0.5	0.5	0.5	0.63	2	0.63	2	T	T	T	T	T
NG125L MA	10	LRD14	07/10			0.4	0.5	0.5	0.5	0.63	0.8	0.63	0.8	T	T	T	T	T
NG125L MA	12.5	LRD16	9/13				0.5	0.5	0.5	0.63	0.8	0.63	0.8	T	T	T	T	T
NG125L MA	16	LRD21	12/18						0.5	0.63	0.8	0.63	0.8	T	T	T	T	T
NG125L MA	25	LRD22	17/25							0.63	0.8	0.63	0.8	T	T	T	T	T
NG125L MA	40	LRD32	23/32								0.8	0.8	0.8	T	T	T	T	T
NG125L MA	40	LRD3355	30/40										0.8	T	T	T	T	T
NG125L MA	63	LRD3357	37/50											T	T	T	T	T
NG125L MA	63	LRD3359	48/65											T	T	T	T	T
GV2 L/LE	03	LRD3	0.25/0.40	T	T	T	T	T	T	T	T	T	T	T	T	T	T	T
GV2 L/LE	04	LRD4	0.40/0.63	T	T	T	T	T	T	T	T	T	T	T	T	T	T	T
GV2 L/LE	05	LRD5	0.63/1	T	T	T	T	T	T	T	T	T	T	T	T	T	T	T
GV2 L/LE	06	LRD6	1/1.6	0.19	T	T	T	T	T	T	T	T	T	T	T	T	T	T
GV2 L/LE	07	LRD7	1.6/2.5	0.19	0.25	0.4	T	T	T	T	T	T	T	T	T	T	T	T
GV2 L/LE	08	LRD8	2.5/4	0.19	0.25	0.4	0.5	0.5	0.5	0.63	0.8	0.63	0.8	T	T	T	T	T
GV2 L/LE	10	LRD10	4/6.3		0.25	0.4	0.5	0.5	0.5	0.63	0.8	0.63	0.8	T	T	T	T	T
GV2 L/LE	14	LRD14	07/10			0.4	0.5	0.5	0.5	0.63	0.8	0.63	0.8	T	T	T	T	T
GV2 L/LE	16	LRD16	9/13				0.5	0.5	0.5	0.63	0.8	0.63	0.8	T	T	T	T	T
GV2 L/LE	20	LRD21	12/18					0.5	0.5	0.63	0.8	0.63	0.8	T	T	T	T	T
GV2 L/LE	22	LRD22	17/25							0.63	0.8	0.63	0.8	T	T	T	T	T
GV2 L/LE	32	LRD32	23/32								0.8	0.8	0.8	T	T	T	T	T
GV3 L	25	LRD22	20/25							0.63	0.8	0.63	0.8	1.25	1.25	1.25	T	T
GV3 L	32	LRD32	23/32								0.8	0.8	0.8	1.25	1.25	1.25	T	T
GV3 L	40	LRD340	30/40											1.25	1.25	1.25	T	T
GV3 L	50	LRD350	37/50											1.25	1.25	1.25	T	T
GV3 L	65	LRD365	48/65											1.25	1.25	1.25	T	T
GV4 L/LE	02	LRD-07	1.6/2.5	0.19	0.25	0.4	0.5	0.5	0.5	0.63	0.8	0.63	0.8	1.25	1.25	1.25	T	T
GV4 L/LE	03	LRD-08	2.5/4		0.25	0.4	0.5	0.5	0.5	0.63	0.8	0.63	0.8	1.25	1.25	1.25	T	T
GV4 L/LE	07	LRD-12	5.5/8		0.25	0.4	0.5	0.5	0.5	0.63	0.8	0.63	0.8	1.25	1.25	1.25	T	T
GV4 L/LE	12	LRD-313	9/13			0.5	0.5	0.5	0.5	0.63	0.8	0.63	0.8	1.25	1.25	1.25	T	T
GV4 L/LE	25	LRD-325	17/25							0.63	0.8	0.63	0.8	1.25	1.25	1.25	T	T
GV4 L/LE	50	LRD-350	37/50											1.25	1.25	1.25	T	T
GV4 L/LE	80	LRD-33 63	63/80											1.25	1.25	1.25	T	T
GV4 L/LE	115	LR9D-5369 LR9-F5369	90/150															T
NSX100 [1]	MA2.5	LRD6	1/1.6	0.19	0.3	T	T	T	T	T	T	T	T	T	T	T	T	T
NSX100 [1]	MA2.5	LRD7	1.6/2.5	0.19	0.3	0.4	0.5	0.5	0.5	T	T	T	T	T	T	T	T	T
NSX100 [1]	MA6.3	LRD8	2.5/4	0.19	0.3	0.4	0.5	0.5	0.5	0.63	0.8	0.63	0.8	T	T	T	T	T
NSX100 [1]	MA6.3	LRD10	4/6.3		0.3	0.4	0.5	0.5	0.5	0.63	0.8	0.63	0.8	T	T	T	T	T
NSX100 [1]	MA12.5	LRD12	5.5/8		0.3	0.4	0.5	0.5	0.5	0.63	0.8	0.63	0.8	1	1	1	T	T
NSX100 [1]	MA12.5	LRD14	9/13			0.4	0.5	0.5	0.5	0.63	0.8	0.63	0.8	1	1	1	T	T
NSX100 [1]	MA12.5	LRD16	12/18				0.5	0.5	0.5	0.63	0.8	0.63	0.8	1	1	1	T	T
NSX100 [1]	MA25	LRD21	17/25					0.5	0.63	0.8	0.63	0.8	0.8	1	1	1	T	T
NSX100 [1]	MA25	LRD22	17/25						0.63	0.8	0.63	0.8	0.8	1	1	1	T	T
NSX100 [1]	MA50	LRD32	23/32							0.8	0.8	0.8	0.8	1	1	1	36	36
NSX100 [1]	MA50	LRD340	30/40										1	1	1	36	36	
NSX100 [1]	MA50	LRD350	37/50											1	1	36	36	
NSX100 [1]	MA100	LRD365	48/65												1	36	36	
NSX100 [1]	MA100	LRD3363	63/80													36	36	

- T Total selectivity, up to the breaking capacity of the downstream circuit breaker.
- 4 Selectivity limit = 4 kA.
- No selectivity.

Note: respect the basic rules of selectivity, in terms of overload, short-circuit, ground fault and earth leakage when applicable see page A-2, or check curves with Schneider Electric online "Electrical calculation tools".

[1] F/N/H/S/L/R

# Motor protection selectivity

Upstream: Compact NSX100 to 160 Micrologic

Downstream: GV2, GV3, GV4, LUB12, LUB32, Integral 63, Compact NSX100 to 250

$U_e \leq 440 \text{ V AC}$

Upstream				NSX100B/F/N/H/S/L/R						NSX160B/F/N/H/S/L					
Trip unit				Micrologic [1]											
Downstream			Rating (A)	40			100			160					
	Trip unit or rating	Th Relay	Setting Ir	16	25	40	40	63	80	100	63	80	100	125	160
				Selectivity limit (kA)											
GV2 ME/P	01	Integrated	0.1/0.16	T	T	T	T	T	T	T	T	T	T	T	T
GV2 ME/P	02	Integrated	0.16/0.25	T	T	T	T	T	T	T	T	T	T	T	T
GV2 ME/P	03	Integrated	0.25/0.40	T	T	T	T	T	T	T	T	T	T	T	T
GV2 ME/P	04	Integrated	0.40/0.63	T	T	T	T	T	T	T	T	T	T	T	T
GV2 ME/P	05	Integrated	0.63/1	T	T	T	T	T	T	T	T	T	T	T	T
GV2 ME/P	06	Integrated	1/1.6	0.6	0.6	0.6	T	T	T	T	T	T	T	T	T
GV2 ME/P	07	Integrated	1.6/2.5	0.6	0.6	0.6	T	T	T	T	T	T	T	T	T
GV2 ME/P	08	Integrated	2.5/4	0.6	0.6	0.6	T	T	T	T	T	T	T	T	T
GV2 ME/P	10	Integrated	4/6.3		0.6	0.6	T	T	T	T	T	T	T	T	T
GV2 ME/P	14	Integrated	06/10			0.6	T	T	T	T	T	T	T	T	T
GV2 ME/P	16	Integrated	9/14					T	T	T	T	T	T	T	T
GV2 ME/P	20	Integrated	13/18					T	T	T	T	T	T	T	T
GV2 ME/P	21	Integrated	17/23						T	T		T	T	T	T
GV2 ME/P	22	Integrated	20/25						T	T		T	T	T	T
GV2 ME/P	32	Integrated	24/32							T		T	T	T	T
GV3 P	13	Integrated	01/13			0.6	1.5	1.5	1.5	1.5	T	T	T	T	T
GV3 P	18	Integrated	12/18					1.5	1.5	1.5	T	T	T	T	T
GV3 P	25	Integrated	17/25						1.5	1.5	T	T	T	T	T
GV3 P	32	Integrated	23/32							1.5		T	T	T	T
GV3 P	40	Integrated	30/40										T	T	T
GV3 P	50	Integrated	37/50											2.4	2.4
GV3 P	65	Integrated	48/65												2.4
GV4P/PE/PEM	02	Integrated	0.8/2	T	T	T	T	T	T	T	T	T	T	T	T
GV4P/PE/PEM	03	Integrated	1.4/3.5	25	25	25	T	T	T	T	T	T	T	T	T
GV4P/PE/PEM	07	Integrated	2.9/7		2	2	2	2	2	2	4	4	4	4	4
GV4P/PE/PEM	12	Integrated	5/12.5					1.5	1.5	1.5	2.4	2.4	2.4	2.4	2.4
GV4P/PE/PEM	25	Integrated	10/25						1.5	1.5		2.4	2.4	2.4	2.4
GV4P/PE/PEM	50	Integrated	20/50												2.4
GV4P/PE/PEM	80	Integrated	40/80												
GV4P/PE/PEM	115	Integrated	65/115												
LUB12		LUCoX6	0.15/0.6	0.6	0.6	0.6	1.5	1.5	1.5	1.5	T	T	T	T	T
LUB12		LUCo1X	0.35...1.4	0.6	0.6	0.6	1.5	1.5	1.5	1.5	T	T	T	T	T
LUB12		LUCo05	1.25...5	0.6	0.6	0.6	1.5	1.5	1.5	1.5	T	T	T	T	T
LUB12		LUCo12	3...12				1.5	1.5	1.5	1.5	T	T	T	T	T
LUB32		LUCoX6	0.15...0.6	0.6	0.6	0.6	1.5	1.5	1.5	1.5	T	T	T	T	T
LUB32		LUCo1X	0.35...1.4	0.6	0.6	0.6	1.5	1.5	1.5	1.5	T	T	T	T	T
LUB32		LUCo05	1.25...5	0.6	0.6	0.6	1.5	1.5	1.5	1.5	T	T	T	T	T
LUB32		LUCo12	3...12				1.5	1.5	1.5	1.5	T	T	T	T	T
LUB32		LUCo18	4.5...18					1.5	1.5	1.5	T	T	T	T	T
LUB32		LUCo32	8...32							1.5		T	T	T	T
Integral 63		LB1-LD03M16	1/13			0.6	1.5	1.5	1.5	1.5	2.4	2.4	2.4	2.4	2.4
Integral 63		LB1-LD03M21	13/18					1.5	1.5	1.5	2.4	2.4	2.4	2.4	2.4
Integral 63		LB1-LD03M22	18/25							1.5	1.5	2.4	2.4	2.4	2.4
Integral 63		LB1-LD03M53	23/32									1.5	2.4	2.4	2.4
Integral 63		LB1-LD03M55	28/40											2.4	2.4
Integral 63		LB1-LD03M57	35/50												2.4
Integral 63		LB1-LD03M61	45/63												
NSX100 F/N/H/S/L/R		Mic. 2.2M or 6.2EM	25/50 100							1.5			2.4	2.4	2.4
NSX160 F/N/H/S/L/R		Mic. 2.2M or 6.2EM	100 150										2.4	2.4	2.4
NSX250 F/N/H/S/L/R		Mic. 2.2M or 6.2EM	150 220												

**T** Total selectivity, up to the breaking capacity of the downstream circuit breaker.

**4** Selectivity limit = 4 kA.

No selectivity.

**Note:** respect the basic rules of selectivity, in terms of overload, short-circuit, ground fault and earth leakage when applicable see page A-2, or check curves with Schneider Electric online "Electrical calculation tools".

**[1]** Valid for all "Distribution" Micrologic of Compact NSX : 2.2, 4.2, 5.2, 6.2, 7.2. Valid for Generators (and Service connection (G and AB type) Micrologic of Compact NSX but curves shall be checked. Not Valid for "Motor" Micrologic of Compact NSX ("M" type).

# Motor protection selectivity

Upstream: Compact NSX100 to 160, Micrologic

Downstream: iC60L MA, NG125L MA, GV2, GV3, GV4, Compact NSX100

U<sub>e</sub> ≤ 440 V AC

Upstream Trip unit			NSX100B/F/N/H/S/L/R				NSX160B/F/N/H/S/L									
			Micrologic [1]													
Downstream			Rating (A) Setting Ir			40				100			160			
CB	Rating	Th Relay	Setting range	16	25	40	40	63	80	100	63	80	100	125	160	
			Selectivity limit (kA)													
iC60L MA	1.6	LRD6	1/1.6	T	T	T	T	T	T	T	T	T	T	T	T	
iC60L MA	2.5	LRD7	1.6/2.5	1	1	1	T	T	T	T	T	T	T	T	T	
iC60L MA	4	LRD8	2.5/4	0.6	0.6	0.6	T	T	T	T	T	T	T	T	T	
iC60L MA	6.3	LRD10	4/6.3	0.6	0.6	0.6	5	5	5	5	T	T	T	T	T	
iC60L MA	10	LRD12	5.5/8		0.6	0.6	2	2	2	2	T	T	T	T	T	
iC60L MA	10	LRD14	07/10			0.6	1.5	1.5	1.5	1.5	T	T	T	T	T	
iC60L MA	12.5	LRD16	9/13			0.6	1.5	1.5	1.5	1.5	T	T	T	T	T	
iC60L MA	16	LRD21	12/18					1.5	1.5	1.5	T	T	T	T	T	
iC60L MA	25	LRD22	17/25						1.5	1.5		T	T	T	T	
iC60L MA	40	LRD32	23/32							1.5			T	T	T	
iC60L MA	40	LRD3355	30/40											T	T	
NG125L MA	1.6	LRD6	1/1.6	T	T	T	T	T	T	T	T	T	T	T	T	
NG125L MA	2.5	LRD7	1.6/2.5	1	1	1	T	T	T	T	T	T	T	T	T	
NG125L MA	4	LRD8	2.5/4	0.6	0.6	0.6	T	T	T	T	T	T	T	T	T	
NG125L MA	6.3	LRD10	4/6.3	0.6	0.6	0.6	5	5	5	5	T	T	T	T	T	
NG125L MA	10	LRD12	5.5/8		0.6	0.6	2	2	2	2	T	T	T	T	T	
NG125L MA	10	LRD14	07/10			0.6	1.5	1.5	1.5	1.5	T	T	T	T	T	
NG125L MA	12.5	LRD16	9/13			0.6	1.5	1.5	1.5	1.5	T	T	T	T	T	
NG125L MA	16	LRD21	12/18					1.5	1.5	1.5	T	T	T	T	T	
NG125L MA	25	LRD22	17/25						1.5	1.5		T	T	T	T	
NG125L MA	40	LRD32	23/32							1.5			T	T	T	
NG125L MA	40	LRD3355	30/40											T	T	
NG125L MA	63	LRD3357	37/50											T	T	
NG125L MA	63	LRD3359	48/65												T	
GV2 L/LE	03	LRD3	0.25/0.40	T	T	T	T	T	T	T	T	T	T	T	T	
GV2 L/LE	04	LRD4	0.40/0.63	T	T	T	T	T	T	T	T	T	T	T	T	
GV2 L/LE	05	LRD5	0.63/1	T	T	T	T	T	T	T	T	T	T	T	T	
GV2 L/LE	06	LRD6	1/1.6	0.6	0.6	0.6	T	T	T	T	T	T	T	T	T	
GV2 L/LE	07	LRD7	1.6/2.5	0.6	0.6	0.6	T	T	T	T	T	T	T	T	T	
GV2 L/LE	08	LRD8	2.5/4	0.6	0.6	0.6	T	T	T	T	T	T	T	T	T	
GV2 L/LE	10	LRD10	4/6.3		0.6	0.6	T	T	T	T	T	T	T	T	T	
GV2 L/LE	14	LRD14	07/10			0.6	T	T	T	T	T	T	T	T	T	
GV2 L/LE	16	LRD16	9/13					T	T	T	T	T	T	T	T	
GV2 L/LE	20	LRD21	12/18						T	T	T	T	T	T	T	
GV2 L/LE	22	LRD22	17/25						T	T	T	T	T	T	T	
GV2 L/LE	32	LRD32	23/32							T	T	T	T	T	T	
GV3 L	25	LRD22	20/25							1.5	1.5					
GV3 L	32	LRD32	23/32									1.5				
GV3 L	40	LRD340	30/40											2.4	2.4	
GV3 L	50	LRD350	37/50												2.4	
GV3 L	65	LRD365	48/65													
GV4 L/LE	02	LRD-07	1.6/2.5	T	T	T	T	T	T	T	T	T	T	T	T	
GV4 L/LE	03	LRD-08	2.5/4	25	25	25	T	T	T	T	T	T	T	T	T	
GV4 L/LE	07	LRD-12	5.5/8		2	2	2	2	2	2	4	4	4	4	4	
GV4 L/LE	12	LRD-313	9/13					1.5	1.5	1.5	2.4	2.4	2.4	2.4	2.4	
GV4 L/LE	25	LRD-325	17/25						1.5	1.5		2.4	2.4	2.4	2.4	
GV4 L/LE	50	LRD-350	37/50												2.4	
GV4 L/LE	80	LRD-33 63	63/80													
GV4 L/LE	115	LR9D-5369 LR9-F5369	90/150													
NSX100	MA2.5	LRD6	1/1.6	T	T	T	T	T	T	T	T	T	T	T	T	
NSX100	MA2.5	LRD7	1.6/2.5	1	1	1	T	T	T	T	T	T	T	T	T	
NSX100	MA6.3	LRD8	2.5/4	0.6	0.6	0.6	1.5	1.5	1.5	1.5	T	T	T	T	T	
NSX100	MA6.3	LRD10	4/6.3		0.6	0.6	1.5	1.5	1.5	1.5	T	T	T	T	T	
NSX100	MA12.5	LRD12	5.5/8		0.6	0.6	1.5	1.5	1.5	1.5	2.4	2.4	2.4	2.4	2.4	
NSX100	MA12.5	LRD14	9/13			0.6	1.5	1.5	1.5	1.5	2.4	2.4	2.4	2.4	2.4	
NSX100	MA12.5	LRD16	12/18			0.6	1.5	1.5	1.5	1.5	2.4	2.4	2.4	2.4	2.4	
NSX100	MA25	LRD21	17/25					1.5	1.5	1.5	2.4	2.4	2.4	2.4	2.4	
NSX100	MA25	LRD22	17/25						1.5	1.5		2.4	2.4	2.4	2.4	
NSX100	MA50	LRD32	23/32							1.5			2.4	2.4	2.4	
NSX100	MA50	LRD340	30/40											2.4	2.4	
NSX100	MA50	LRD350	37/50												2.4	
NSX100	MA100	LRD365	48/65													
NSX100	MA100	LRD3363	63/80													

- T Total selectivity, up to the breaking capacity of the downstream circuit breaker.
- 4 Selectivity limit = 4 kA.
- No selectivity.

**Note:** respect the basic rules of selectivity, in terms of overload, short-circuit, ground fault and earth leakage when applicable see page A-2, or check curves with Schneider Electric online "Electrical calculation tools".

[1] Valid for all "Distribution" Micrologic of Compact NSX : 2.2, 4.2, 5.2, 6.2, 7.2. Valid for Generators (and Service connection (G and AB type) Micrologic of Compact NSX but curves shall be checked. Not Valid for "Motor" Micrologic of Compact NSX ("M" type).

# Motor protection selectivity

Upstream: Compact NSX250 to 630 Micrologic

Downstream: GV2, GV3, GV4, LUB12, LUB32, Integral 63, Compact NSX100 to 250

$U_e \leq 440 \text{ V AC}$

Upstream			NSX250B/F/N/H/S/L/R	NSX400F/N/H/S/L/R								NSX630F/N/H/S/L/R							
Trip unit			Micrologic [1]																
Downstream			Rating (A)	250				400				630							
CB	Rating	Th Relay	Ir setting	100	125	160	200	250	160	200	250	320	400	250	320	400	500	630	
			Setting range	Selectivity limit (kA)															
GV2 ME/P	01	Integrated	0.1/0.16	T	T	T	T	T	T	T	T	T	T	T	T	T	T	T	
GV2 ME/P	02	Integrated	0.16/0.25	T	T	T	T	T	T	T	T	T	T	T	T	T	T	T	
GV2 ME/P	03	Integrated	0.25/0.40	T	T	T	T	T	T	T	T	T	T	T	T	T	T	T	
GV2 ME/P	04	Integrated	0.40/0.63	T	T	T	T	T	T	T	T	T	T	T	T	T	T	T	
GV2 ME/P	05	Integrated	0.63/1	T	T	T	T	T	T	T	T	T	T	T	T	T	T	T	
GV2 ME/P	06	Integrated	1/1.6	T	T	T	T	T	T	T	T	T	T	T	T	T	T	T	
GV2 ME/P	07	Integrated	1.6/2.5	T	T	T	T	T	T	T	T	T	T	T	T	T	T	T	
GV2 ME/P	08	Integrated	2.5/4	T	T	T	T	T	T	T	T	T	T	T	T	T	T	T	
GV2 ME/P	10	Integrated	4/6.3	T	T	T	T	T	T	T	T	T	T	T	T	T	T	T	
GV2 ME/P	14	Integrated	06/10	T	T	T	T	T	T	T	T	T	T	T	T	T	T	T	
GV2 ME/P	16	Integrated	9/14	T	T	T	T	T	T	T	T	T	T	T	T	T	T	T	
GV2 ME/P	20	Integrated	13/18	T	T	T	T	T	T	T	T	T	T	T	T	T	T	T	
GV2 ME/P	21	Integrated	17/23	T	T	T	T	T	T	T	T	T	T	T	T	T	T	T	
GV2 ME/P	22	Integrated	20/25	T	T	T	T	T	T	T	T	T	T	T	T	T	T	T	
GV2 ME/P	32	Integrated	24/32	T	T	T	T	T	T	T	T	T	T	T	T	T	T	T	
GV3 P	13	Integrated	01/13	T	T	T	T	T	T	T	T	T	T	T	T	T	T	T	
GV3 P	18	Integrated	12/18	T	T	T	T	T	T	T	T	T	T	T	T	T	T	T	
GV3 P	25	Integrated	17/25	T	T	T	T	T	T	T	T	T	T	T	T	T	T	T	
GV3 P	32	Integrated	23/32	T	T	T	T	T	T	T	T	T	T	T	T	T	T	T	
GV3 P	40	Integrated	30/40		T	T	T	T	T	T	T	T	T	T	T	T	T	T	
GV3 P	50	Integrated	37/50			T	T	T	T	T	T	T	T	T	T	T	T	T	
GV3 P	65	Integrated	48/65				T	T	T	T	T	T	T	T	T	T	T	T	
GV4P/PE/PEM	02	Integrated	0.8/2	T	T	T	T	T	T	T	T	T	T	T	T	T	T	T	
GV4P/PE/PEM	03	Integrated	1.4/3.5	T	T	T	T	T	T	T	T	T	T	T	T	T	T	T	
GV4P/PE/PEM	07	Integrated	2.9/7	T	T	T	T	T	T	T	T	T	T	T	T	T	T	T	
GV4P/PE/PEM	12	Integrated	5/12.5	T	T	T	T	T	T	T	T	T	T	T	T	T	T	T	
GV4P/PE/PEM	25	Integrated	10/25	T	T	T	T	T	T	T	T	T	T	T	T	T	T	T	
GV4P/PE/PEM	50	Integrated	20/50			T	T	T	T	T	T	T	T	T	T	T	T	T	
GV4P/PE/PEM	80	Integrated	40/80				T				T	T	T	T	T	T	T	T	
GV4P/PE/PEM	115	Integrated	65/115									T	T	T	T	T	T	T	
LUB12		LUCoX6	0.15/0.6	T	T	T	T	T	T	T	T	T	T	T	T	T	T	T	
LUB12		LUCo1X	0.35...1.4	T	T	T	T	T	T	T	T	T	T	T	T	T	T	T	
LUB12		LUCo05	1.25...5	T	T	T	T	T	T	T	T	T	T	T	T	T	T	T	
LUB12		LUCo12	3...12	T	T	T	T	T	T	T	T	T	T	T	T	T	T	T	
LUB32		LUCoX6	0.15...0.6	T	T	T	T	T	T	T	T	T	T	T	T	T	T	T	
LUB32		LUCo1X	0.35...1.4	T	T	T	T	T	T	T	T	T	T	T	T	T	T	T	
LUB32		LUCo05	1.25...5	T	T	T	T	T	T	T	T	T	T	T	T	T	T	T	
LUB32		LUCo12	3...12	T	T	T	T	T	T	T	T	T	T	T	T	T	T	T	
LUB32		LUCo18	4.5...18	T	T	T	T	T	T	T	T	T	T	T	T	T	T	T	
LUB32		LUCo32	8...32	T	T	T	T	T	T	T	T	T	T	T	T	T	T	T	
Integral 63		LB1-LD03M16	1/13	T	T	T	T	T	T	T	T	T	T	T	T	T	T	T	
Integral 63		LB1-LD03M21	13/18	T	T	T	T	T	T	T	T	T	T	T	T	T	T	T	
Integral 63		LB1-LD03M22	18/25	T	T	T	T	T	T	T	T	T	T	T	T	T	T	T	
Integral 63		LB1-LD03M53	23/32	T	T	T	T	T	T	T	T	T	T	T	T	T	T	T	
Integral 63		LB1-LD03M55	28/40		T	T	T	T	T	T	T	T	T	T	T	T	T	T	
Integral 63		LB1-LD03M57	35/50			T	T	T	T	T	T	T	T	T	T	T	T	T	
Integral 63		LB1-LD03M61	45/63				T	T	T	T	T	T	T	T	T	T	T	T	
NSX100 F/N/H/S/L/R		Mic. 2.2M or 6.2EM	25/50	36	36	36	36	36	T	T	T	T	T	T	T	T	T	T	
NSX160 F/N/H/S/L/R		Mic. 2.2M or 6.2EM	100					36				T	T	T	T	T	T	T	
NSX250 F/N/H/S/L/R		Mic. 2.2M or 6.2EM	150					3					4.8			T	T	T	
NSX250 F/N/H/S/L/R		Mic. 2.2M or 6.2EM	220													T	T	T	

**T** Total selectivity, up to the breaking capacity of the downstream circuit breaker.

**4** Selectivity limit = 4 kA.

No selectivity.

**Note:** respect the basic rules of selectivity, in terms of overload, short-circuit, ground fault and earth leakage when applicable see page A-2, or check curves with Schneider Electric online "Electrical calculation tools".

**[1]** Valid for all "Distribution" Micrologic of Compact NSX : 2.2/3, 4.2/3 5.2/3, 6.2/3, 7.2/3. Valid for Generators (and Service connection (G and AB type) Micrologic of Compact NSX but curves shall be checked. Not Valid for "Motor" Micrologic of Compact NSX ("M" type).

# Motor protection selectivity

Upstream: Compact NSX250 to 630 Micrologic

Downstream: iC60L MA, NG125L MA, GV2, GV3, GV4, Compact NSX100 to 250

$U_e \leq 440 \text{ V AC}$

Upstream			NSX250B/F/N/H/S/L/R	NSX400F/N/H/S/L/R					NSX630F/N/H/S/L/R									
Trip unit			Micrologic [1]															
Downstream			Rating (A)	250					400					630				
CB	Rating	Th Relay	Ir setting	100	125	160	200	250	160	200	250	320	400	250	320	400	500	630
			Setting range	Selectivity limit (kA)														
iC60L MA	1.6	LRD6	1/1.6	T	T	T	T	T	T	T	T	T	T	T	T	T	T	T
iC60L MA	2.5	LRD7	1.6/2.5	T	T	T	T	T	T	T	T	T	T	T	T	T	T	T
iC60L MA	4	LRD8	2.5/4	T	T	T	T	T	T	T	T	T	T	T	T	T	T	T
iC60L MA	6.3	LRD10	4/6.3	T	T	T	T	T	T	T	T	T	T	T	T	T	T	T
iC60L MA	10	LRD12	5.5/8	T	T	T	T	T	T	T	T	T	T	T	T	T	T	T
iC60L MA	10	LRD14	07/10	T	T	T	T	T	T	T	T	T	T	T	T	T	T	T
iC60L MA	12.5	LRD16	9/13	T	T	T	T	T	T	T	T	T	T	T	T	T	T	T
iC60L MA	16	LRD21	12/18	T	T	T	T	T	T	T	T	T	T	T	T	T	T	T
iC60L MA	25	LRD22	17/25	T	T	T	T	T	T	T	T	T	T	T	T	T	T	T
iC60L MA	40	LRD32	23/32	T	T	T	T	T	T	T	T	T	T	T	T	T	T	T
iC60L MA	40	LRD3355	30/40	T	T	T	T	T	T	T	T	T	T	T	T	T	T	T
NG125L MA	1.6	LRD6	1/1.6	T	T	T	T	T	T	T	T	T	T	T	T	T	T	T
NG125L MA	2.5	LRD7	1.6/2.5	T	T	T	T	T	T	T	T	T	T	T	T	T	T	T
NG125L MA	4	LRD8	2.5/4	T	T	T	T	T	T	T	T	T	T	T	T	T	T	T
NG125L MA	6.3	LRD10	4/6.3	T	T	T	T	T	T	T	T	T	T	T	T	T	T	T
NG125L MA	10	LRD12	5.5/8	T	T	T	T	T	T	T	T	T	T	T	T	T	T	T
NG125L MA	10	LRD14	07/10	T	T	T	T	T	T	T	T	T	T	T	T	T	T	T
NG125L MA	12.5	LRD16	9/13	T	T	T	T	T	T	T	T	T	T	T	T	T	T	T
NG125L MA	16	LRD21	12/18	T	T	T	T	T	T	T	T	T	T	T	T	T	T	T
NG125L MA	25	LRD22	17/25	T	T	T	T	T	T	T	T	T	T	T	T	T	T	T
NG125L MA	40	LRD32	23/32	T	T	T	T	T	T	T	T	T	T	T	T	T	T	T
NG125L MA	40	LRD3355	30/40	T	T	T	T	T	T	T	T	T	T	T	T	T	T	T
NG125L MA	63	LRD3357	37/50			T	T	T	T	T	T	T	T	T	T	T	T	T
NG125L MA	63	LRD3359	48/65				T	T	T	T	T	T	T	T	T	T	T	T
GV2 L/LE	03	LRD3	0.25/0.40	T	T	T	T	T	T	T	T	T	T	T	T	T	T	T
GV2 L/LE	04	LRD4	0.40/0.63	T	T	T	T	T	T	T	T	T	T	T	T	T	T	T
GV2 L/LE	05	LRD5	0.63/1	T	T	T	T	T	T	T	T	T	T	T	T	T	T	T
GV2 L/LE	06	LRD6	1/1.6	T	T	T	T	T	T	T	T	T	T	T	T	T	T	T
GV2 L/LE	07	LRD7	1.6/2.5	T	T	T	T	T	T	T	T	T	T	T	T	T	T	T
GV2 L/LE	08	LRD8	2.5/4	T	T	T	T	T	T	T	T	T	T	T	T	T	T	T
GV2 L/LE	10	LRD10	4/6.3	T	T	T	T	T	T	T	T	T	T	T	T	T	T	T
GV2 L/LE	14	LRD14	07/10	T	T	T	T	T	T	T	T	T	T	T	T	T	T	T
GV2 L/LE	16	LRD16	9/13	T	T	T	T	T	T	T	T	T	T	T	T	T	T	T
GV2 L/LE	20	LRD21	12/18	T	T	T	T	T	T	T	T	T	T	T	T	T	T	T
GV2 L/LE	22	LRD22	17/25	T	T	T	T	T	T	T	T	T	T	T	T	T	T	T
GV2 L/LE	32	LRD32	23/32	T	T	T	T	T	T	T	T	T	T	T	T	T	T	T
GV3 L	25	LRD22	20/25	T	T	T	T	T	T	T	T	T	T	T	T	T	T	T
GV3 L	32	LRD32	23/32	T	T	T	T	T	T	T	T	T	T	T	T	T	T	T
GV3 L	40	LRD340	30/40		T	T	T	T	T	T	T	T	T	T	T	T	T	T
GV3 L	50	LRD350	37/50			T	T	T	T	T	T	T	T	T	T	T	T	T
GV3 L	65	LRD365	48/65				T	T	T	T	T	T	T	T	T	T	T	T
GV4 L/LE	02	LRD-07	1.6/2.5	T	T	T	T	T	T	T	T	T	T	T	T	T	T	T
GV4 L/LE	03	LRD-08	2.5/4	T	T	T	T	T	T	T	T	T	T	T	T	T	T	T
GV4 L/LE	07	LRD-12	5.5/8	T	T	T	T	T	T	T	T	T	T	T	T	T	T	T
GV4 L/LE	12	LRD-313	9/13	T	T	T	T	T	T	T	T	T	T	T	T	T	T	T
GV4 L/LE	25	LRD-325	17/25	T	T	T	T	T	T	T	T	T	T	T	T	T	T	T
GV4 L/LE	50	LRD-350	37/50			T	T	T	T	T	T	T	T	T	T	T	T	T
GV4 L/LE	80	LRD-33 63	63/80				T	T	T	T	T	T	T	T	T	T	T	T
GV4 L/LE	115	LR9/F-5369	90/150								T	T	T	T	T	T	T	T
NSX100	MA2.5	LRD6	1/1.6	T	T	T	T	T	T	T	T	T	T	T	T	T	T	T
NSX100	MA2.5	LRD7	1.6/2.5	T	T	T	T	T	T	T	T	T	T	T	T	T	T	T
NSX100	MA6.3	LRD8	2.5/4	T	T	T	T	T	T	T	T	T	T	T	T	T	T	T
NSX100	MA6.3	LRD10	4/6.3	T	T	T	T	T	T	T	T	T	T	T	T	T	T	T
NSX100	MA12.5	LRD12	5.5/8	T	T	T	T	T	T	T	T	T	T	T	T	T	T	T
NSX100	MA12.5	LRD14	9/13	T	T	T	T	T	T	T	T	T	T	T	T	T	T	T
NSX100	MA12.5	LRD16	12/18	T	T	T	T	T	T	T	T	T	T	T	T	T	T	T
NSX100	MA25	LRD21	17/25	T	T	T	T	T	T	T	T	T	T	T	T	T	T	T
NSX100	MA25	LRD22	17/25	T	T	T	T	T	T	T	T	T	T	T	T	T	T	T
NSX100	MA50	LRD32	23/32	36	36	36	36	36	T	T	T	T	T	T	T	T	T	T
NSX100	MA50	LRD340	30/40		36	36	36	36	T	T	T	T	T	T	T	T	T	T
NSX100	MA50	LRD350	37/50			36	36	36	T	T	T	T	T	T	T	T	T	T
NSX100	MA100	LRD365	48/65				36	36	T	T	T	T	T	T	T	T	T	T
NSX100	MA100	LRD3363	63/80					36		T	T	T	T	T	T	T	T	T
NSX160	MA150	LR9D/F 5369	90/150										T	T	T	T	T	T
NSX250	MA220	LR9D/F 5371	132/220															T

- T** Total selectivity, up to the breaking capacity of the downstream circuit breaker.
- 4** Selectivity limit = 4 kA.
- No selectivity.

**Note:** respect the basic rules of selectivity, in terms of overload, short-circuit, ground fault and earth leakage when applicable see page A-2, or check curves with Schneider Electric online "Electrical calculation tools".  
**[1]** Valid for all "Distribution" Micrologic of Compact NSX : 2.2/3, 4.2/3 5.2/3, 6.2/3, 7.2/3. Valid for Generators (and Service connection (G and AB type) Micrologic of Compact NSX but curves shall be checked. Not Valid for "Motor" Micrologic of Compact NSX ("M" type).



# Motor protection selectivity

Upstream: Compact NS630b to 1600 N/H

Downstream: iC60L MA, NG125L MA, LUB12, LUB32, GV2, GV3, GV4, Compact NSX100 to 630

$U_e \leq 440 \text{ V AC}$

Upstream		NS630b 800 1000 1250 1600 N/H								NS630b 800 1000 1250 1600 N/H								NS630b 800 1000 1250 1600 N/H													
Trip unit		Micrologic 2.0								Micrologic 5.0 - 6.0 - 7.0								Micrologic 5.0 - 6.0 - 7.0													
		Inst...In								Inst...In								Inst OFF													
Downstream	Rating	630		800		1000		1250		1600		630		800		1000		1250		1600		630		800		1000		1250		1600	
	Setting Ir	250	400	630	800	1000	1250	1600	250	400	630	800	1000	1250	1600	250	400	630	800	1000	1250	1600	250	400	630	800	1000	1250	1600		
<b>Selectivity limit (kA)</b>																															
iC60 L MA1.6...MA40 + LRD		T	T	T	T	T	T	T	T	T	T	T	T	T	T	T	T	T	T	T	T	T	T	T	T	T	T	T	T		
NG125L MA2.5...MA63 + LRD		T	T	T	T	T	T	T	T	T	T	T	T	T	T	T	T	T	T	T	T	T	T	T	T	T	T	T	T		
LUB12 + LUC6..12		T	T	T	T	T	T	T	T	T	T	T	T	T	T	T	T	T	T	T	T	T	T	T	T	T	T	T	T		
LUB32 + LUC6..32		T	T	T	T	T	T	T	T	T	T	T	T	T	T	T	T	T	T	T	T	T	T	T	T	T	T	T	T		
GV2 ME01...ME32		T	T	T	T	T	T	T	T	T	T	T	T	T	T	T	T	T	T	T	T	T	T	T	T	T	T	T	T		
GV2 P01...P32		T	T	T	T	T	T	T	T	T	T	T	T	T	T	T	T	T	T	T	T	T	T	T	T	T	T	T	T		
GV2 L03..L32 + LRD		T	T	T	T	T	T	T	T	T	T	T	T	T	T	T	T	T	T	T	T	T	T	T	T	T	T	T	T		
GV3 P13...P65		T	T	T	T	T	T	T	T	T	T	T	T	T	T	T	T	T	T	T	T	T	T	T	T	T	T	T	T		
GV3 L25..L65 + LRD		T	T	T	T	T	T	T	T	T	T	T	T	T	T	T	T	T	T	T	T	T	T	T	T	T	T	T	T		
GV4 P/PE/PEM 02-115		T	T	T	T	T	T	T	T	T	T	T	T	T	T	T	T	T	T	T	T	T	T	T	T	T	T	T	T		
GV4 L/LE 02-115 +LRD		T	T	T	T	T	T	T	T	T	T	T	T	T	T	T	T	T	T	T	T	T	T	T	T	T	T	T	T		
NSX100 F/N/H/S/L MA 2.5...MA6.3 + LRD		T	T	T	T	T	T	T	T	T	T	T	T	T	T	T	T	T	T	T	T	T	T	T	T	T	T	T	T		
NSX100 F/N/H/S/L/R MA12.5...MA100 + LRD		T	T	T	T	T	T	T	T	T	T	T	T	T	T	T	T	T	T	T	T	T	T	T	T	T	T	T	T		
NSX160 F/N/H/S/L MA150 + LR9D/F	150		T	T	T	T	T	T	T	T	T	T	T	T	T	T	T	T	T	T	T	T	T	T	T	T	T	T	T		
NSX250 F/N/H/S/L/R MA220 + LR9D/F	220			T	T	T	T	T	T	T	T	T	T	T	T	T	T	T	T	T	T	T	T	T	T	T	T	T	T		
NSX400 F/N/H/S/L/R Mic. 1.3M +LR9F	320					T	T	T							T	T	T										T	T	T		
NSX630 F/N Mic. 1.3M +LR9F	500							T																					T		
NSX630 H/S/L/R Mic. 1.3M +LR9F	500							65																					65		
NSX100 F/N/H/S/L/R Mic. 2.2M 6.2M	25	T	T	T	T	T	T	T	T	T	T	T	T	T	T	T	T	T	T	T	T	T	T	T	T	T	T	T	T		
	50	T	T	T	T	T	T	T	T	T	T	T	T	T	T	T	T	T	T	T	T	T	T	T	T	T	T	T	T		
	100 (80)	T	T	T	T	T	T	T	T	T	T	T	T	T	T	T	T	T	T	T	T	T	T	T	T	T	T	T	T		
NSX160 F/N/H/S/L Mic. 2.2M 6.2M	≤ 100	T	T	T	T	T	T	T	T	T	T	T	T	T	T	T	T	T	T	T	T	T	T	T	T	T	T	T	T		
	150		T	T	T	T	T	T							T	T	T										T	T	T		
NSX250 F/N/H/S/L/R Mic. 2.2M 6.2M	≤ 150		T	T	T	T	T	T							T	T	T										T	T	T		
	220			T	T	T	T	T							T	T	T										T	T	T		
NSX400 F/N/H/S/L/R Mic. 2.3M 6.3M	320					T	T	T							T	T	T										T	T	T		
NSX630 F/N Mic. 2.3M 6.3M	500							T																					T		
NSX630H/S/L/R Mic. 2.3M 6.3M	500							65																					65		

Total selectivity, up to the breaking capacity of the downstream circuit breaker.

Selectivity limit = 4 kA.

No selectivity.

**Note:** respect the basic rules of selectivity, in terms of overload, short-circuit, ground fault and earth leakage when applicable see page A-2, or check curves with Schneider Electric online "Electrical calculation tools".

# Motor protection selectivity

Upstream: Compact NS630b to 1000 L

Downstream: iC60L MA, NG125L MA, LUB12, LUB32, GV2, GV3, GV4, Compact NSX100 to 630

$U_e \leq 440 \text{ V AC}$

B

Upstream		NS630b 800 1000 L														
Trip Unit		Micrologic 2.0					Micrologic 5.0 - 6.0 - 7.0 Inst 15 In					Micrologic 5.0 - 6.0 - 7.0 Inst OFF				
Downstream	Rating	630			800	1000	630			800	1000	630			800	1000
	Setting Ir	250	400	630	800	1000	250	400	630	800	1000	250	400	630	800	1000
<b>Selectivity limit (kA)</b>																
iC60 L MA1.6 ... MA40 + LRD		T	T	T	T	T	T	T	T	T	T	T	T	T	T	T
NG125L MA2.5 .. MA63 + LRD		T	T	T	T	T	T	T	T	T	T	T	T	T	T	T
LUB12 + LUC6..12		T	T	T	T	T	T	T	T	T	T	T	T	T	T	T
LUB32 + LUC6..32		T	T	T	T	T	T	T	T	T	T	T	T	T	T	T
GV2 ME01..ME32		T	T	T	T	T	T	T	T	T	T	T	T	T	T	T
GV2 P01 .. P32		T	T	T	T	T	T	T	T	T	T	T	T	T	T	T
GV2 L03..L32 + LRD		T	T	T	T	T	T	T	T	T	T	T	T	T	T	T
GV3 P13 .. P65		T	T	T	T	T	T	T	T	T	T	T	T	T	T	T
GV3 L25..L65 + LRD		T	T	T	T	T	T	T	T	T	T	T	T	T	T	T
GV4 P/PE/PEM 02-115		T	T	T	T	T	T	T	T	T	T	T	T	T	T	T
GV4 L/LE 02-115 +LRD		T	T	T	T	T	T	T	T	T	T	T	T	T	T	T
NSX100 F/N/H/S/L MA 2.5 .. MA6.3 + LRD		T	T	T	T	T	T	T	T	T	T	T	T	T	T	T
NSX100 F/N/H/S/L/R MA12.5 .. MA100 + LRD		T	T	T	T	T	T	T	T	T	T	T	T	T	T	T
NSX160 F MA150 + LR9D/F	150		T	T	T	T	T	T	T	T	T	T	T	T	T	T
NSX160N/H/S/L MA150 + LR9D/F	150		36	36	T	T		36	36	T	T		36	36	T	T
NSX250 F/N/H/S/L/R MA220 + LR9D/F	220			20	T	T	20	20	20	T	T	20	20	20	T	T
NSX400F/N/H/S/L/R Micrologic 1.3M +LR9F	320					15										15
NSX630 F/N/H/S/L/R Micrologic 1.3M +LR9F	500					10										10
NSX100 FN/H/S/L/R Micrologic 2.2M 6.2M	25	T	T	T	T	T	T	T	T	T	T	T	T	T	T	T
	50	T	T	T	T	T	T	T	T	T	T	T	T	T	T	T
	100 (80)	T	T	T	T	T	T	T	T	T	T	T	T	T	T	T
NSX160 F/N/H/S/L Micrologic 2.2M 6.2M	≤ 100	36	36	36	T	T	36	36	36	T	T	36	36	36	T	T
	150		36	36	T	T		36	36	T	T		36	36	T	T
NSX250 F/N/H/S/L/R Micrologic 2.2M 6.2M	≤ 150		20	20	T	T		20	20	T	T		20	20	T	T
	220			20	T	T			20	T	T			20	T	T
NSX400F/N/H/S/L/R Micrologic 2.3M 6.3M	320				15	15				15	15				15	15
NSX630F/N/H/S/L/R Micrologic 2.3M 6.3M	500					10					10					10

Total selectivity, up to the breaking capacity of the downstream circuit breaker.

Selectivity limit = 4 kA.

No selectivity.

**Note:** respect the basic rules of selectivity, in terms of overload, short-circuit, ground fault and earth leakage when applicable see page A-2, or check curves with Schneider Electric online "Electrical calculation tools".

# Motor protection selectivity

Upstream: Compact NS1600b - 3200 N

Downstream: iC60L MA, NG125L MA, LUB12, LUB32, GV2, GV3, GV4, Compact NSX100 to 630

$U_e \leq 440 \text{ V AC}$

Upstream		NS1600 2000 2500 3200 N											
Trip Unit		Micrologic 2.0				Micrologic 5.0 - 6.0 - 7.0 Inst 15In				Micrologic 5.0 - 6.0 - 7.0 Inst OFF			
Downstream	Rating	1600	2000	2500	3200	1600	2000	2500	3200	1600	2000	2500	3200
<b>Selectivity limit (kA)</b>													
iC60 L MA1.6 ... MA40 + LRD		T	T	T	T	T	T	T	T	T	T	T	T
NG125L MA2.5 .. MA63 + LRD		T	T	T	T	T	T	T	T	T	T	T	T
LUB12 + LUC6..12		T	T	T	T	T	T	T	T	T	T	T	T
LUB32 + LUC6..32		T	T	T	T	T	T	T	T	T	T	T	T
GV2 ME01..ME32		T	T	T	T	T	T	T	T	T	T	T	T
GV2 P01 .. P32		T	T	T	T	T	T	T	T	T	T	T	T
GV2 L03..L32 + LRD		T	T	T	T	T	T	T	T	T	T	T	T
GV3 P13 .. P65		T	T	T	T	T	T	T	T	T	T	T	T
GV3 L25..L65 + LRD		T	T	T	T	T	T	T	T	T	T	T	T
GV4 P/PE/PEM 02-115		T	T	T	T	T	T	T	T	T	T	T	T
GV4 L/LE 02-115 +LRD		T	T	T	T	T	T	T	T	T	T	T	T
NSX100 F/N/H/S/L MA 2.5 .. MA6.3 + LRD		T	T	T	T	T	T	T	T	T	T	T	T
NSX100 F/N/H/S/L/R MA12.5 .. MA100 + LRD		T	T	T	T	T	T	T	T	T	T	T	T
NSX160 F/N/H/S/L MA150 + LR9D/F	150	T	T	T	T	T	T	T	T	T	T	T	T
NSX250 F/N/H/S/L/R MA220 + LR9D/F	220	T	T	T	T	T	T	T	T	T	T	T	T
NSX400F/N/H/S/L/R Micrologic 1.3M +LR9F	320	T	T	T	T	T	T	T	T	T	T	T	T
NSX630 F/N/H/S/L/R Micrologic 1.3M +LR9F	500	T	T	T	T	T	T	T	T	T	T	T	T
NSX100 F/N/H/S/L/R Micrologic 2.2M 6.2M	25	T	T	T	T	T	T	T	T	T	T	T	T
	50	T	T	T	T	T	T	T	T	T	T	T	T
	100 (80)	T	T	T	T	T	T	T	T	T	T	T	T
NSX160 F/N/H/S/L Micrologic 2.2M 6.2M	≤ 100	T	T	T	T	T	T	T	T	T	T	T	T
	150	T	T	T	T	T	T	T	T	T	T	T	T
NSX250 F/N/H/S/L/R Micrologic 2.2M 6.2M	≤ 150	T	T	T	T	T	T	T	T	T	T	T	T
	220	T	T	T	T	T	T	T	T	T	T	T	T
NSX400 F/N/H/S/L/R Micrologic 2.3M 6.3M	320	T	T	T	T	T	T	T	T	T	T	T	T
NSX630 F/N/H/S/L/R Micrologic 2.3M 6.3M	320	T	T	T	T	T	T	T	T	T	T	T	T
	500	T	T	T	T	T	T	T	T	T	T	T	T

Total selectivity, up to the breaking capacity of the downstream circuit breaker.  
 No selectivity.

**Note:** respect the basic rules of selectivity, in terms of overload, short-circuit, ground fault and earth leakage when applicable see page A-2, or check curves with Schneider Electric online "Electrical calculation tools".

B

# Motor protection selectivity

Upstream: Masterpact MTZ1 06-16 H1/H2/H3

Downstream: iC60L MA, NG125L MA, LUB12, LUB32, GV2, GV3, GV4, Compact NSX100 to 630

$U_e \leq 440 \text{ V AC}$

B

Upstream		Masterpact MTZ1 06/08/10/12/16 H1/H2/H3																			
Trip Unit		Micrologic 2.0X						Micrologic 5.0X - 6.0X - 7.0X Inst 15 In						Micrologic 5.0X - 6.0X - 7.0X Inst OFF							
Downstream	Rating	630		800		1000		1250		1600		630		800		1000		1250		1600	
	Setting Ir	250	400	630	800	1000	1250	1600	250	400	630	800	1000	1250	1600	250	400	630	800	1000	1250
Selectivity limit (kA)																					
iC60 L MA1.6...MA40 + LRD		T	T	T	T	T	T	T	T	T	T	T	T	T	T	T	T	T	T	T	T
NG125L MA2.5...MA63 + LRD		T	T	T	T	T	T	T	T	T	T	T	T	T	T	T	T	T	T	T	T
LUB12 + LUC6...12		T	T	T	T	T	T	T	T	T	T	T	T	T	T	T	T	T	T	T	T
LUB32 + LUC6...32		T	T	T	T	T	T	T	T	T	T	T	T	T	T	T	T	T	T	T	T
GV2 ME01...ME32		T	T	T	T	T	T	T	T	T	T	T	T	T	T	T	T	T	T	T	T
GV2 P01...P32		T	T	T	T	T	T	T	T	T	T	T	T	T	T	T	T	T	T	T	T
GV2 L03...L32 + LRD		T	T	T	T	T	T	T	T	T	T	T	T	T	T	T	T	T	T	T	T
GV3 P13...P65		T	T	T	T	T	T	T	T	T	T	T	T	T	T	T	T	T	T	T	T
GV3 L25...L65 + LRD		T	T	T	T	T	T	T	T	T	T	T	T	T	T	T	T	T	T	T	T
GV4 P/PE/PEM 02-115		T	T	T	T	T	T	T	T	T	T	T	T	T	T	T	T	T	T	T	T
GV4 L/LE 02-115 +LRD		T	T	T	T	T	T	T	T	T	T	T	T	T	T	T	T	T	T	T	T
NSX100 F/N/H/S/L MA 2.5...MA6.3 + LRD		T	T	T	T	T	T	T	T	T	T	T	T	T	T	T	T	T	T	T	T
NSX100 F/N/H/S/L/R MA12.5...MA100 + LRD		T	T	T	T	T	T	T	T	T	T	T	T	T	T	T	T	T	T	T	T
NSX160 F/N/H/S/L MA150 + LR9D/F	150		T	T	T	T	T			T	T	T	T	T			T	T	T	T	T
NSX250 F/N/H/S/L/R MA220 + LR9D/F	220			T	T	T	T				T	T	T	T				T	T	T	T
NSX400F/N/H/S/L/R Micrologic 1.3M +LR9F	320					T	T	T					T	T	T					T	T
NSX630 F/N/H/S/L/R Micrologic 1.3M +LR9F	500																				T
NSX100 FN/H/S/L/R Micrologic 2.2M 6.2M	25	T	T	T	T	T	T	T	T	T	T	T	T	T	T	T	T	T	T	T	T
	50	T	T	T	T	T	T	T	T	T	T	T	T	T	T	T	T	T	T	T	T
	100 (80)		T	T	T	T	T			T	T	T	T	T			T	T	T	T	T
NSX160 F/N/H/S/L Micrologic 2.2M 6.2M	≤ 100	T	T	T	T	T	T	T	T	T	T	T	T	T	T	T	T	T	T	T	T
	150		T	T	T	T	T			T	T	T	T	T			T	T	T	T	T
NSX250 F/N/H/S/L/R Micrologic 2.2M 6.2M	≤ 150	T	T	T	T	T	T	T	T	T	T	T	T	T	T	T	T	T	T	T	T
	220		T	T	T	T	T			T	T	T	T	T			T	T	T	T	T
NSX400 F/N/H/S/L/R Micrologic 2.3M 6.3M	320						T	T						T	T					T	T
NSX630 F/N/H/S/L/R Micrologic 2.3M 6.3M	400							T	T						T	T				T	T
	500									T						T					T

- T Total selectivity, up to the breaking capacity of the downstream circuit breaker.
- 4 Selectivity limit = 4 kA.
- No selectivity.

**Note:** respect the basic rules of selectivity, in terms of overload, short-circuit, ground fault and earth leakage when applicable see page A-2, or check curves with Schneider Electric online "Electrical calculation tools".

# Motor protection selectivity

Upstream: Masterpact MTZ1 06-10 L1

Downstream: iC60L MA, NG125L MA, LUB12, LUB32, GV2, GV3, GV4, Compact NSX100 to 630

$U_e \leq 440 \text{ V AC}$

Upstream		Masterpact MTZ1 06/08/10 L1																				
Trip Unit		Micrologic 2.0X					Micrologic 5.0X - 6.0X - 7.0X Inst 15 In					Micrologic 5.0X - 6.0X - 7.0X Inst OFF										
Downstream	Rating Setting I <sub>r</sub>	630			800		1000		630			800		1000		630		800		1000		
		250	400	630	800	1000	250	400	630	800	1000	250	400	630	800	1000	250	400	630	800	1000	
<b>Selectivity limit (kA)</b>																						
iC60 L MA1.6...MA40 + LRD		T	T	T	T	T	T	T	T	T	T	T	T	T	T	T	T	T	T	T	T	
NG125L MA2.5...MA63 + LRD		T	T	T	T	T	T	T	T	T	T	T	T	T	T	T	T	T	T	T	T	
LUB12 + LUC6...12		T	T	T	T	T	T	T	T	T	T	T	T	T	T	T	T	T	T	T	T	
LUB32 + LUC6...32		T	T	T	T	T	T	T	T	T	T	T	T	T	T	T	T	T	T	T	T	
GV2 ME01...ME32		T	T	T	T	T	T	T	T	T	T	T	T	T	T	T	T	T	T	T	T	
GV2 P01...P32		T	T	T	T	T	T	T	T	T	T	T	T	T	T	T	T	T	T	T	T	
GV2 L03...L32 + LRD		T	T	T	T	T	T	T	T	T	T	T	T	T	T	T	T	T	T	T	T	
GV3 P13...P65		T	T	T	T	T	T	T	T	T	T	T	T	T	T	T	T	T	T	T	T	
GV3 L25...L65 + LRD		T	T	T	T	T	T	T	T	T	T	T	T	T	T	T	T	T	T	T	T	
GV4 P/PE/PEM 02-115		T	T	T	T	T	T	T	T	T	T	T	T	T	T	T	T	T	T	T	T	
GV4 L/LE 02-115 +LRD		T	T	T	T	T	T	T	T	T	T	T	T	T	T	T	T	T	T	T	T	
NSX100 F/N/H/S/L MA 2.5...MA6.3 + LRD		T	T	T	T	T	T	T	T	T	T	T	T	T	T	T	T	T	T	T	T	
NSX100 F/N/H/S/L/R MA12.5...MA100 + LRD		T	T	T	T	T	T	T	T	T	T	T	T	T	T	T	T	T	T	T	T	
NSX160 F MA150 + LR9D/F			T	T	T	T	T	T	T	T	T	T	T	T	T	T	T	T	T	T	T	
NSX160 N/H/S/L MA150 + LR9D/F			36	36	T	T		36	36	T	T		36	36	T	T		36	36	T	T	
NSX250 F/N/H/S/L/R MA220 + LR9D/F				20	T	T			20	T	T			20	T	T			20	T	T	
NSX400 F/N/H/S/L/R Mic. 1.3M + LR9F						15					15										15	
NSX630 F/N/H/S/L/R Mic. 1.3M +LR9F																						
NSX100 F/N/H/S/L/R Mic. 2.2M 6.2M		25	T	T	T	T	T	T	T	T	T	T	T	T	T	T	T	T	T	T	T	
		50	T	T	T	T	T	T	T	T	T	T	T	T	T	T	T	T	T	T	T	
		100 (80)	T	T	T	T	T	T	T	T	T	T	T	T	T	T	T	T	T	T	T	
NSX160 F Mic. 2.2M 6.2M		≤ 100	T	T	T	T	T	T	T	T	T	T	T	T	T	T	T	T	T	T	T	
		150		T	T	T	T		T	T	T	T		T	T	T	T		T	T	T	
NSX160 N/H/S/L Mic. 2.2M 6.2M		≤ 100	36	36	36	T	T	36	36	36	T	T	36	36	36	T	T	36	36	36	T	T
		150		36	36	T	T		36	36	T	T		36	36	T	T		36	36	T	T
NSX250 F/N/H/S/L/R Mic. 2.2M 6.2M		≤ 150		20	20	T	T		20	20	T	T		20	20	T	T		20	20	T	T
		220			20	T	T			20	T	T			20	T	T			20	T	T
NSX400 F/N/H/S/L/R Mic. 2.3M 6.3M		320				15	15				15	15								15	15	
NSX630 F/N/H/S/L/R Mic. 2.3M 6.3M		500					10					10									10	

- T Total selectivity, up to the breaking capacity of the downstream circuit breaker.
- 4 Selectivity limit = 4 kA.
- No selectivity.

**Note:** respect the basic rules of selectivity, in terms of overload, short-circuit, ground fault and earth leakage when applicable see page A-2, or check curves with Schneider Electric online "Electrical calculation tools".



# Motor protection selectivity

Upstream: Masterpact MTZ2 08/10/12/16/20 N1/H1/H2/L1

Downstream: iC60L MA, NG125L MA, LUB12, LUB32, GV2, GV3, GV4, Compact NSX100 to 630

$U_e \leq 440 \text{ V AC}$

Upstream		Masterpact MTZ2 08/10/12/16/20 N1/H1/H2/L1																			
Trip Unit		Micrologic 2.0X								Micrologic 5.0X - 6.0X - 7.0X Inst 15 In								Micrologic 5.0X - 6.0X - 7.0X Inst OFF			
Downstream	Rating Setting Ir	800				1000				1250				1600				2000			
		320	630	800	1000	1250	1600	2000	320	630	800	1000	1250	1600	2000	320	630	800	1000	1250	1600
Selectivity limit (kA)																					
iC60 L MA1.6...MA40 + LRD		T	T	T	T	T	T	T	T	T	T	T	T	T	T	T	T	T	T	T	T
NG125L MA2.5...MA63 + LRD		T	T	T	T	T	T	T	T	T	T	T	T	T	T	T	T	T	T	T	T
LUB12 + LUC6...12		T	T	T	T	T	T	T	T	T	T	T	T	T	T	T	T	T	T	T	T
LUB32 + LUC6...32		T	T	T	T	T	T	T	T	T	T	T	T	T	T	T	T	T	T	T	T
GV2 ME01...ME32		T	T	T	T	T	T	T	T	T	T	T	T	T	T	T	T	T	T	T	T
GV2 P01...P32		T	T	T	T	T	T	T	T	T	T	T	T	T	T	T	T	T	T	T	T
GV2 L03...L32 + LRD		T	T	T	T	T	T	T	T	T	T	T	T	T	T	T	T	T	T	T	T
GV3 P13...P65		T	T	T	T	T	T	T	T	T	T	T	T	T	T	T	T	T	T	T	T
GV3 L25...L65 + LRD		T	T	T	T	T	T	T	T	T	T	T	T	T	T	T	T	T	T	T	T
GV4 P/PE/PEM 02-115		T	T	T	T	T	T	T	T	T	T	T	T	T	T	T	T	T	T	T	T
GV4 L/LE 02-115 +LRD		T	T	T	T	T	T	T	T	T	T	T	T	T	T	T	T	T	T	T	T
NSX100 F/N/H/S/L MA 2.5 .. MA6.3 + LRD		T	T	T	T	T	T	T	T	T	T	T	T	T	T	T	T	T	T	T	T
NSX100 F/N/H/S/L/R MA12.5 .. MA100 + LRD		T	T	T	T	T	T	T	T	T	T	T	T	T	T	T	T	T	T	T	T
NSX160 F/N/H/S/L MA150 + LR9D/F	150	T	T	T	T	T	T	T	T	T	T	T	T	T	T	T	T	T	T	T	T
NSX250 F/N/H/S/L/R MA220 + LR9D/F	220		T	T	T	T	T		T	T	T	T	T	T		T	T	T	T	T	T
NSX400F/N/H/S/L/R Micrologic 1.3M +LR9F	320				T	T	T				T	T	T	T				T	T	T	T
NSX630 F/N/H/S/L/R Micrologic 1.3M +LR9F	500					T	T						T	T						T	T
NSX100 FN/H/S/L/R Micrologic 2.2M 6.2M	25	T	T	T	T	T	T	T	T	T	T	T	T	T	T	T	T	T	T	T	T
	50	T	T	T	T	T	T	T	T	T	T	T	T	T	T	T	T	T	T	T	T
	100 (80)	T	T	T	T	T	T	T	T	T	T	T	T	T	T	T	T	T	T	T	T
NSX160 F/N/H/S/L Micrologic 2.2M 6.2M	≤ 100	T	T	T	T	T	T	T	T	T	T	T	T	T	T	T	T	T	T	T	T
	150		T	T	T	T	T		T	T	T	T	T		T	T	T	T	T	T	T
NSX250 F/N/H/S/L/R Micrologic 2.2M 6.2M	≤ 150		T	T	T	T	T		T	T	T	T	T		T	T	T	T	T	T	T
	220		T	T	T	T	T		T	T	T	T	T		T	T	T	T	T	T	T
NSX400F/N/H/S/L/R Micrologic 2.3 6.3M	320				T	T	T				T	T	T	T				T	T	T	T
NSX630F/N/H/S/L/R Micrologic 2.3 6.3M	500					T	T						T	T						T	T

- T Total selectivity, up to the breaking capacity of the downstream circuit breaker.
- 4 Selectivity limit = 4 kA.
- No selectivity.

**Note:** respect the basic rules of selectivity, in terms of overload, short-circuit, ground fault and earth leakage when applicable see page A-2, or check curves with Schneider Electric online "Electrical calculation tools".

# Motor protection selectivity

Upstream: Masterpact MTZ2 25/32/40 H1/H2, MTZ3 40/50/63 H1

Downstream: iC60L MA, NG125L MA, LUB12, LUB32, GV2, GV3, GV4, Compact NSX100 to 630

$U_e \leq 440 \text{ V AC}$

Upstream	MTZ2 25/32/40 H1/H2	MTZ3 40/50/63 H1	MTZ2 25/32/40 H1/H2	MTZ3 40/50/63 H1	MTZ2 25/32/40 H1/H2	MTZ3 40/50/63 H1
Trip Unit	Micrologic 2.0X		Micrologic 5.0X - 6.0X - 7.0X Inst 15 in		Micrologic 5.0X - 6.0X - 7.0X Inst OFF	

Downstream	Rating	2500	3200	4000	4000	5000	6300	2500	3200	4000	4000	5000	6300	2500	3200	4000	4000	5000	6300
Selectivity limit (kA)																			
iC60 L MA1.6...MA40 + LRD		T	T	T	T	T	T	T	T	T	T	T	T	T	T	T	T	T	T
NG125L MA2.5...MA63 + LRD		T	T	T	T	T	T	T	T	T	T	T	T	T	T	T	T	T	T
LUB12 + LUC6...12		T	T	T	T	T	T	T	T	T	T	T	T	T	T	T	T	T	T
LUB32 + LUC6...32		T	T	T	T	T	T	T	T	T	T	T	T	T	T	T	T	T	T
GV2 ME01...ME32		T	T	T	T	T	T	T	T	T	T	T	T	T	T	T	T	T	T
GV2 P01...P32		T	T	T	T	T	T	T	T	T	T	T	T	T	T	T	T	T	T
GV2 L03...L32 + LRD		T	T	T	T	T	T	T	T	T	T	T	T	T	T	T	T	T	T
GV3 P13...P65		T	T	T	T	T	T	T	T	T	T	T	T	T	T	T	T	T	T
GV3 L25...L65 + LRD		T	T	T	T	T	T	T	T	T	T	T	T	T	T	T	T	T	T
GV4 P/PE/PEM 02-115		T	T	T	T	T	T	T	T	T	T	T	T	T	T	T	T	T	T
GV4 L/LE 02-115 +LRD		T	T	T	T	T	T	T	T	T	T	T	T	T	T	T	T	T	T
NSX100 F/N/H/S/L MA 2.5 .. MA6.3 + LRD		T	T	T	T	T	T	T	T	T	T	T	T	T	T	T	T	T	T
NSX100 F/N/H/S/L/R MA12.5 .. MA100+LRD		T	T	T	T	T	T	T	T	T	T	T	T	T	T	T	T	T	T
NSX160 F/N/H/S/L MA150 + LR9D/F		150	T	T	T	T	T	T	T	T	T	T	T	T	T	T	T	T	T
NSX250 F/N/H/S/L/R MA220 + LR9D/F		220	T	T	T	T	T	T	T	T	T	T	T	T	T	T	T	T	T
NSX400 F/N/H/S/L/R Micrologic 1.3M+LR9F		320	T	T	T	T	T	T	T	T	T	T	T	T	T	T	T	T	T
NSX630 F/N/H/S/L/R Micrologic 1.3M+LR9F		500	T	T	T	T	T	T	T	T	T	T	T	T	T	T	T	T	T
NSX100 FN/H/S/L/R Micrologic 2.2M 6.2M		25/50/ 100	T	T	T	T	T	T	T	T	T	T	T	T	T	T	T	T	T
NSX160 F/N/H/S/L Micrologic 2.2M 6.2M		150	T	T	T	T	T	T	T	T	T	T	T	T	T	T	T	T	T
NSX250 F/N/H/S/L/R Micrologic 2.2M 6.2M		≤ 150	T	T	T	T	T	T	T	T	T	T	T	T	T	T	T	T	T
		220	T	T	T	T	T	T	T	T	T	T	T	T	T	T	T	T	T
NSX400 F/N/H/S/L/R Micrologic 2.3 6.3M		320	T	T	T	T	T	T	T	T	T	T	T	T	T	T	T	T	T
NSX630 F/N/H/S/L/R Micrologic 2.3 6.3M		500	T	T	T	T	T	T	T	T	T	T	T	T	T	T	T	T	T

**T** Total selectivity, up to the breaking capacity of the downstream circuit breaker.

**Note:** respect the basic rules of selectivity, in terms of overload, short-circuit, ground fault and earth leakage when applicable see page A-2, or check curves with Schneider Electric online "Electrical calculation tools".

# Motor protection selectivity

Upstream: Masterpact MTZ2 20/25/32/40 H3, MTZ3 40/50/63 H2

Downstream: iC60L MA, NG125L MA, LUB12, LUB32, GV2, GV3, GV4,  
Compact NSX100 to 630

U<sub>e</sub> ≤ 440 V AC

B

Upstream	MTZ2 20/25/32/40		MTZ3 40/50/63		MTZ2 20/25/32/40		MTZ3 40/50/63		MTZ2 20/25/32/40		MTZ3 40/50/63	
	H3		H2		H3		H2		H3		H2	
Trip Unit	Micrologic 2.0X				Micrologic 5.0X - 6.0X - 7.0X Inst 15 In				Micrologic 5.0X - 6.0X - 7.0X Inst OFF			

Downstream	2000	2500	3200	4000	4000	5000	6300	2000	2500	3200	4000	4000	5000	6300	2000	2500	3200	4000	4000	5000	6300
Selectivity limit (kA)																					
iC60 L MA1.6...MA40 + LRD	T	T	T	T	T	T	T	T	T	T	T	T	T	T	T	T	T	T	T	T	T
NG125L MA2.5...MA63 + LRD	T	T	T	T	T	T	T	T	T	T	T	T	T	T	T	T	T	T	T	T	T
LUB12 + LUC6...12	T	T	T	T	T	T	T	T	T	T	T	T	T	T	T	T	T	T	T	T	T
LUB32 + LUC6...32	T	T	T	T	T	T	T	T	T	T	T	T	T	T	T	T	T	T	T	T	T
GV2 ME01...ME32	T	T	T	T	T	T	T	T	T	T	T	T	T	T	T	T	T	T	T	T	T
GV2 P01...P32	T	T	T	T	T	T	T	T	T	T	T	T	T	T	T	T	T	T	T	T	T
GV2 L03...L32 + LRD	T	T	T	T	T	T	T	T	T	T	T	T	T	T	T	T	T	T	T	T	T
GV3 P13...P65	T	T	T	T	T	T	T	T	T	T	T	T	T	T	T	T	T	T	T	T	T
GV3 L25...L65 + LRD	T	T	T	T	T	T	T	T	T	T	T	T	T	T	T	T	T	T	T	T	T
GV4 P/PE/PEM 02-115	T	T	T	T	T	T	T	T	T	T	T	T	T	T	T	T	T	T	T	T	T
GV4 L/LE 02-115 + LRD	T	T	T	T	T	T	T	T	T	T	T	T	T	T	T	T	T	T	T	T	T
NSX100 F/N/H/S/L MA 2.5...MA6.3 + LRD	T	T	T	T	T	T	T	T	T	T	T	T	T	T	T	T	T	T	T	T	T
NSX100 F/N/H/S/L/R MA12.5...MA100 + LRD	T	T	T	T	T	T	T	T	T	T	T	T	T	T	T	T	T	T	T	T	T
NSX160 F/N/H/S/L MA150 + LR9D/F	T	T	T	T	T	T	T	T	T	T	T	T	T	T	T	T	T	T	T	T	T
NSX250 F/N/H/S/L/R MA220 + LR9D/F	T	T	T	T	T	T	T	T	T	T	T	T	T	T	T	T	T	T	T	T	T
NSX400 F/N/H/S/L/R Micrologic 1.3M + LR9F	T	T	T	T	T	T	T	T	T	T	T	T	T	T	T	T	T	T	T	T	T
NSX630 F/N/H/S/L/R Micrologic 1.3M + LR9F	T	T	T	T	T	T	T	T	T	T	T	T	T	T	T	T	T	T	T	T	T
NSX100 FN/H/S/L/R Micrologic 2.2M 6.2M	T	T	T	T	T	T	T	T	T	T	T	T	T	T	T	T	T	T	T	T	T
NSX160 F/N/H/S/L Micrologic 2.2M 6.2M	T	T	T	T	T	T	T	T	T	T	T	T	T	T	T	T	T	T	T	T	T
NSX250 F/N/H/S/L/R Micrologic 2.2M 6.2M	T	T	T	T	T	T	T	T	T	T	T	T	T	T	T	T	T	T	T	T	T
NSX400 F/N/H/S/L/R Micrologic 2.3 6.3M 320	T	T	T	T	T	T	T	T	T	T	T	T	T	T	T	T	T	T	T	T	T
NSX630 F/N/H/S/L/R Micrologic 2.3 6.3M 500	T	T	T	T	T	T	T	T	T	T	T	T	T	T	T	T	T	T	T	T	T

- Total selectivity, up to the breaking capacity of the downstream circuit breaker.
- Selectivity limit = 4 kA.
- No selectivity.

Note: respect the basic rules of selectivity, in terms of overload, short-circuit, ground fault and earth leakage when applicable see page A-2, or check curves with Schneider Electric online "Electrical calculation tools".



# Motor protection cascading

Upstream: NG125, Compact NSXm, NSX100, NSX160, NSX250, NSX400, NSX630

Downstream: iC60L MA, NG125L MA, LUB12, LUB32, GV2, GV3, GV4

Ue ≤ 380-415 V AC

Ph/N 220/240 V AC

Upstream CB	NG125			NSXm					NSX100					
	N	H	L	E	B	F	N	H	B	F	N	H	S	L
Icu (kA)	25	36	50	16	25	36	50	70	25	36	50	70	100	150

Downstream			Reinforced breaking capacity (kA)															
	Rating (A)	Icu (kA)																
iC60L MA	1.6-16	20	25	36	50		25	36	36	36	25	36	40	40	40	40		
	25-60	15	25	36	36	16	25	30	30	30	25	30	30	30	30	30		
NG125L MA	1.6-80	50										70		70	100	150		
	01-14	100																
GV2 ME	16-32	15									25	36	40	50	50	50		
	01-16	100																
GV2 P	20-32	50												70	100	150		
	01-16	100												70	100	150		
GV2 L	20-32	50												70	100	150		
	01-16	100												70	100	150		
GV3 P	40-65	50												70	100	150		
	01-16	100												70	100	150		
GV3 L	40-65	50												70	100	150		
	01-16	100												70	100	150		
LUB12	0.15-12	50												70	100	150		
	01-16	100												70	100	150		
LUB32	0.15-32	50												70	100	150		
	01-16	100												70	100	150		
GV4L & LE B	2-115A	25								36	36	50		36	36	50	50	50
	01-16	100																
GV4L & LE N	2-115A	50												70	100	100	100	100
	01-16	100												70	100	100	100	100
GV4L & LE S	2-115A	100																
	01-16	100																
GV4P, PE, PEM B	2-115A	25												36	36	50	50	50
	01-16	100																
GV4P, PE, PEM N	2-115A	50												70	100	100	100	100
	01-16	100												70	100	100	100	100
GV4P, PE, PEM S	2-115A	100																
	01-16	100																

Upstream CB	NSX160						NSX250					
	B	F	N	H	S	L	B	F	N	H	S	L
Icu (kA)	25	36	50	70	100	150	25	36	50	70	100	150

Downstream			Reinforced breaking capacity (kA)													
	Rating (A)	Icu (kA)														
iC60L MA	1.6-16	20	25	36	40	40	40	40	25	30	30	30	30	30	30	
	25-60	15	25	30	30	30	30	30	25	25	25	25	25	25	25	
NG125L MA	1.6-80	50											70	100	150	
	01-14	100														
GV2 ME	16-32	15	25	36	40	50	50	50	25	36	40	50	50	50	50	
	01-16	100														
GV2 P	20-32	50												70	100	150
	01-16	100												70	100	150
GV2 L	20-32	50												70	100	150
	01-16	100												70	100	150
GV3 P	40-65	50												70	100	150
	01-16	100												70	100	150
GV3 L	40-65	50												70	100	150
	01-16	100												70	100	150
LUB12	0.15-12	50												70	100	150
	01-16	100												70	100	150
LUB32	0.15-32	50												70	100	150
	01-16	100												70	100	150
GV4L & LE B	2-115A	25		36	36	50	50	50		36	36	50	50	50	50	
	01-16	100														
GV4L & LE N	2-115A	50												70	100	100
	01-16	100												70	100	100
GV4L & LE S	2-115A	100														
	01-16	100														
GV4P, PE, PEM B	2-115A	25		36	36	50	50	50		36	36	50	50	50	50	
	01-16	100														
GV4P, PE, PEM N	2-115A	50												70	100	100
	01-16	100												70	100	100
GV4P, PE, PEM S	2-115A	100														
	01-16	100														

Upstream CB	NSX400					NSX630				
	F	N	H	S	L	F	N	H	S	L
Icu (kA)	25	36	50	70	100	150	25	36	100	150

Downstream			Reinforced breaking capacity (kA)									
	Rating (A)	Icu (kA)										
GV4L & LE B	2-115A	25	36	36	50	50	50	36	36	50	50	50
	01-16	100										
GV4L & LE N	2-115A	50								70	100	100
	01-16	100										
GV4L & LE S	2-115A	100										
	01-16	100										
GV4P, PE, PEM B	2-115A	25	36	36	50	50	50	36	36	50	50	50
	01-16	100										
GV4P, PE, PEM N	2-115A	50								70	100	100
	01-16	100										
GV4P, PE, PEM S	2-115A	100										
	01-16	100										

Note: For Compact NSX with motor trip unit downstream: use Electrical distribution tables.

# Motor protection cascading

Upstream: Compact NSXm, NSX100, NSX160, NSX250, NSX400, NSX630

Downstream: GV4

$U_e \leq 440 \text{ V AC}$

Upstream CB	NSXm					NSX100					
	E	B	F	N	H	B	F	N	H	S	L
Icu (kA)	10	20	35	50	65	20	35	50	65	90	130

Downstream			Reinforced breaking capacity (kA)										
	Rating (A)	Icu (kA)											
GV4L, LE B	2-115	20			35	35	50		35	35	50	50	50
GV4L, LE N	2-115	50					65				65	90	100
GV4L, LE S	2-115	70										90	130
GV4P, PE, PEM B	2-115	20			35	35	50		35	35	50	50	50
GV4P, PE, PEM N	2-115	50					65				65	90	100
GV4P, PE, PEM S	2-115	70										90	130

Upstream CB	NSX160						NSX250					
	B	F	N	H	S	L	B	F	N	H	S	L
Icu (kA)	20	35	50	65	90	130	20	35	50	65	90	130

Downstream			Reinforced breaking capacity (kA)											
	Rating (A)	Icu (kA)												
GV4L, LE B	2-115A	20		35	35	50	50	50		35	35	50	50	50
GV4L, LE N	2-115A	50				65	90	100				65	90	100
GV4L, LE S	2-115A	70					90	130					90	130
GV4P, PE, PEM B	2-115A	20		35	35	50	50	50		35	35	50	50	50
GV4P, PE, PEM N	2-115A	50				65	90	100				65	90	100
GV4P, PE, PEM S	2-115A	70					90	130					90	130

Upstream CB	NSX400					NSX630				
	F	N	H	S	L	F	N	H	S	L
Icu (kA)	35	50	65	90	130	35	50	65	90	130

Downstream			Reinforced breaking capacity (kA)									
	Rating (A)	Icu (kA)										
GV4L, LE B	2-115A	20	35	35	50	50	50	35	35	50	50	50
GV4L, LE N	2-115A	50			65	90	100			65	90	100
GV4L, LE S	2-115A	70				90	130				90	130
GV4P, PE, PEM B	2-115A	20	35	35	50	50	50	35	35	50	50	50
GV4P, PE, PEM N	2-115A	50			65	90	100			65	90	100
GV4P, PE, PEM S	2-115A	70				90	130				90	130

**Note:** For Compact NSX with motor trip unit downstream: use Electrical distribution tables.

# Motor protection cascading

Upstream: NG125, Compact NSXm, NSX100, NSX160, NSX250, NSX400, NSX630

Downstream: iC60L MA, NG125L MA, LUB12, LUB32, GV2, GV3, GV4

U<sub>e</sub> ≤ 220-240 V AC

Ph/N 110-130 V AC

Upstream CB	NG125			NSXm					NSX100					
	N	H	L	E	B	F	N	H	B	F	N	H	S	L
Icu (kA)	50	70	100	25	50	85	90	100	40	85	90	100	120	150

Downstream			Reinforced breaking capacity (kA)													
	Rating (A)	Icu (kA)														
iC60L MA	1.6-16	40	50	70	100							65	80	80	80	80
	25-60	30	50	70	70						40	80	80	80	80	80
NG125L MA	1.6-80	100													120	150
GV2 ME	01-14	100														
	16-32	50										85	90	100	100	100
GV2 P	01-16	100														
	20-32	100														
GV2 L	01-16	100														
	20-32	50										85	85	100		
GV3 P	13-65	100										85	90	100	100	100
GV3 L	13-65	100														
LUB12	0.15-12	50													120	150
LUB32	0.15-32	50													120	150
GV4L, LE B	2-115A	50										85	85	100	100	100
GV4L, LE N	2-115A	100													120	150
GV4L, LE S	2-115A	120														150
GV4P, PE, PEM B	2-115A	50										85	85	100	100	100
GV4P, PE, PEM N	2-115A	100													120	150
GV4P, PE, PEM S	2-115A	120														150

Upstream CB	NSX160						NSX250					
	B	F	N	H	S	L	B	F	N	H	S	L
Icu (kA)	40	85	90	100	120	150	40	85	90	100	120	150

Downstream			Reinforced breaking capacity (kA)											
	Rating (A)	Icu (kA)												
iC60L MA	1.6-16	40		65	80	80	80	80		65	80	80	80	80
	25-60	30	40	80	80	80	80	80	40	50	65	65	65	65
NG125L MA	1.6-80	100											120	150
GV2 ME	01-14	100												
	16-32	50		85	90	100	100	100		85	90	100	100	100
GV2 P	01-16	100												
	20-32	100												
GV2 L	01-16	100												
	20-32	50		85	90	100	100	100		85	90	100	100	100
GV3 P	40-65	100												
GV3 L	40-65	100												
LUB12	0.15-12	50		85	85	100	100	100		85	85	100	100	100
LUB32	0.15-32	50											120	150
GV4L, LE B	2-115A	50												150
GV4L, LE N	2-115A	100		85	85	100	100	100		85	85	100	100	100
GV4L, LE S	2-115A	120											120	150
GV4P, PE, PEM B	2-115A	50		85	85	100	100	100		85	85	100	100	100
GV4P, PE, PEM N	2-115A	100											120	150
GV4P, PE, PEM S	2-115A	120						150						150

Upstream CB	NSX400					NSX630				
	F	N	H	S	L	F	N	H	S	L
Icu (kA)	40	85	100	120	150	40	85	100	120	150

Downstream												
	Rating (A)	Icu (kA)										
GV4L, LE B	2-115A	50		85	100	100	100		85	100	100	100
GV4L, LE N	2-115A	100					120	150			120	150
GV4L, LE S	2-115A	120					150					150
GV4P, PE, PEM B	2-115A	50		85	100	100	100		85	100	100	100
GV4P, PE, PEM N	2-115A	100					120	150			120	150

Note: For Compact NSX with motor trip unit downstream: use Electrical distribution tables.

# Selectivity enhanced by cascading

Upstream: Compact NSX160, NSX250, NSX400

Downstream: LUB12, LUB32, Integral 63

Ue: 380-415 V AC

B

Upstream	NSX160H	NSX160S	NSX160L	NSX250H	NSX250S	NSX250L
Breaking capacity	70 kA	100 kA	150 kA	70 kA	100 kA	150 kA
Trip unit	TM-D					

Downst.	Thermal relay	Rating (A)	80/100	125/160	80/100	125/160	80/100	125/160	160	200/250	160	200/250	160	200/250
LUB12	LUC $\bullet$ X6	0.15/0.6		70/70		100/100		150/150	70/70	70/70	100/100	100/100	100/100	100/100
	LUC $\bullet$ 1X	0.35/1.4		70/70		100/100		150/150	70/70	70/70	100/100	100/100	100/100	100/100
	LUC $\bullet$ 05	1.25/5		70/70		100/100		150/150	70/70	70/70	100/100	100/100	100/100	100/100
	LUC $\bullet$ 12	3/12		70/70		100/100		150/150	70/70	70/70	100/100	100/100	100/100	100/100
LUB32	LUC $\bullet$ X6	0.15/0.6		5/70		5/100		5/150	5/70	70/70	5/100	100/100	5/100	100/100
	LUC $\bullet$ 1X	0.35/1.4		5/70		5/100		5/150	5/70	70/70	5/100	100/100	5/100	100/100
	LUC $\bullet$ 05	1.25/5		5/70		5/100		5/150	5/70	70/70	5/100	100/100	5/100	100/100
	LUC $\bullet$ 12	3/12		5/70		5/100		5/150	5/70	70/70	5/100	100/100	5/100	100/100
	LUC $\bullet$ 18	4.5/18		5/70		5/100		5/150	5/70	70/70	5/100	100/100	5/100	100/100
	LUC $\bullet$ 32	8/32		5/70		5/100		5/150	5/70	70/70	5/100	100/100	5/100	100/100
Integral 63	LB1-LD03M16	10/13							70/70		100/100		150/150	
LD1-LD030	LB1-LD03M21	11/18							70/70		100/100		150/150	
LD4-LD130	LB1-LD03M22	18/25							70/70		100/100		150/150	
LD4-LD030	LB1-LD03M53	23/32							70/70		100/100		150/150	
	LB1-LD03M55	28/40							70/70		100/100		150/150	
	LB1-LD03M57	35/50							70/70		100/100		150/150	
	LB1-LD03M61	45/63							70/70		100/100		150/150	

Upstream	NSX160H	NSX160L	NSX160L	NSX250H	NSX250S	NSX250L	NSX400H	NSX400S	NSX400L
Breaking capacity	70 kA	100 kA	150 kA	70 kA	100 kA	150 kA	70 kA	100 kA	150 kA
Trip unit	Micrologic								

Downst.	Thermal relay	Rating (A)	160	160	160	250	250	250	400	400	400
LUB12	LUC $\bullet$ X6	0.15/0.6	70/70	100/100	150/150	70/70	100/100	100/100			
	LUC $\bullet$ 1X	0.35/1.4	70/70	100/100	150/150	70/70	100/100	100/100			
	LUC $\bullet$ 05	1.25/5	70/70	100/100	150/150	70/70	100/100	100/100			
	LUC $\bullet$ 12	3/12	70/70	100/100	150/150	70/70	100/100	100/100			
LUB32	LUC $\bullet$ X6	0.15/0.6	5/70	5/100	5/150	70/70	100/100	100/100			
	LUC $\bullet$ 1X	0.35/1.4	5/70	5/100	5/150	70/70	100/100	100/100			
	LUC $\bullet$ 05	1.25/5	5/70	5/100	5/150	70/70	100/100	100/100			
	LUC $\bullet$ 12	3/12	5/70	5/100	5/150	70/70	100/100	100/100			
	LUC $\bullet$ 18	4.5/18	5/70	5/100	5/150	70/70	100/100	100/100			
	LUC $\bullet$ 32	8/32	5/70	5/100	5/150	70/70	100/100	100/100			
Integral 63	LB1-LD03M16	10/13	70/70	100/100	150/150	70/70	100/100	150/150	70/70	100/100	150/150
LD1-LD030	LB1-LD03M21	11/18				70/70	100/100	150/150	70/70	100/100	150/150
LD4-LD130	LB1-LD03M22	18/25				70/70	100/100	150/150	70/70	100/100	150/150
LD4-LD030	LB1-LD03M53	23/32				70/70	100/100	150/150	70/70	100/100	150/150
	LB1-LD03M55	28/40				70/70	100/100	150/150	70/70	100/100	150/150
	LB1-LD03M57	35/50				70/70	100/100	150/150	70/70	100/100	150/150
	LB1-LD03M61	45/63				70/70	100/100	150/150	70/70	100/100	150/150

Note: respect the basic rules of selectivity, in terms of overload, short-circuit, ground fault and earth leakage when applicable see page A-2, or check curves with Schneider Electric online "Electrical calculation tools".

# Selectivity enhanced by cascading

Upstream: Compact NSX160

Downstream: GV2 ME

Ue: 380-415 V AC

Upstream	NSX160B	NSX160F
Breaking capacity	25 kA	36 kA
Trip unit	TM-D	

Downst.	Thermal relay	Rating (A)	16	25	40	63	80	100	125	160	16	25	32	40/50	63	80	100	125	160	
GV2 ME01	Integrated	0.1/0.16	25/25	25/25	25/25	25/25	25/25	25/25	25/25	25/25	36/36	36/36	36/36	36/36	36/36	36/36	36/36	36/36	36/36	36/36
GV2 ME02	Integrated	0.16/0.25	25/25	25/25	25/25	25/25	25/25	25/25	25/25	25/25	36/36	36/36	36/36	36/36	36/36	36/36	36/36	36/36	36/36	36/36
GV2 ME03	Integrated	0.25/0.40	25/25	25/25	25/25	25/25	25/25	25/25	25/25	25/25	36/36	36/36	36/36	36/36	36/36	36/36	36/36	36/36	36/36	36/36
GV2 ME04	Integrated	0.40/0.63	25/25	25/25	25/25	25/25	25/25	25/25	25/25	25/25	36/36	36/36	36/36	36/36	36/36	36/36	36/36	36/36	36/36	36/36
GV2 ME05	Integrated	0.63/1	25/25	25/25	25/25	25/25	25/25	25/25	25/25	25/25	36/36	36/36	36/36	36/36	36/36	36/36	36/36	36/36	36/36	36/36
GV2 ME06	Integrated	1/1.6		25/25	25/25	25/25	25/25	25/25	25/25	25/25		36/36	36/36	36/36	36/36	36/36	36/36	36/36	36/36	36/36
GV2 ME07	Integrated	1.6/2.5			25/25	25/25	25/25	25/25	25/25	25/25			36/36	36/36	36/36	36/36	36/36	36/36	36/36	36/36
GV2 ME08	Integrated	2.5/4							25/25	25/25									36/36	36/36
GV2 ME10	Integrated	4/6.3							25/25	25/25									36/36	36/36
GV2 ME14	Integrated	6/10							25/25	25/25									36/36	36/36
GV2 ME16	Integrated	9/14							25/25	25/25									36/36	36/36
GV2 ME20	Integrated	13/18							25/25	25/25									36/36	36/36
GV2 ME21	Integrated	17/23							25/25	25/25									36/36	36/36
GV2 ME22	Integrated	20/25							25/25	25/25									36/36	36/36
GV2 ME32	Integrated	24/32							25/25	25/25									36/36	36/36



Upstream	NSX160N/H/S/L
Breaking capacity	50/70/100/150 kA
Trip unit	TM-D

Downst.	Thermal relay	Rating (A)	16	25	32	40	50	63	80	100	125	160
GV2 ME01	Integrated	0.1/0.16	50/50	50/50	50/50	50/50	50/50	50/50	50/50	50/50	50/50	50/50
GV2 ME02	Integrated	0.16/0.25	50/50	50/50	50/50	50/50	50/50	50/50	50/50	50/50	50/50	50/50
GV2 ME03	Integrated	0.25/0.40	50/50	50/50	50/50	50/50	50/50	50/50	50/50	50/50	50/50	50/50
GV2 ME04	Integrated	0.40/0.63	50/50	50/50	50/50	50/50	50/50	50/50	50/50	50/50	50/50	50/50
GV2 ME05	Integrated	0.63/1	50/50	50/50	50/50	50/50	50/50	50/50	50/50	50/50	50/50	50/50
GV2 ME06	Integrated	1/1.6		50/50	50/50	50/50	50/50	50/50	50/50	50/50	50/50	50/50
GV2 ME07	Integrated	1.6/2.5			50/50	50/50	50/50	50/50	50/50	50/50	50/50	50/50
GV2 ME08	Integrated	2.5/4									50/50	50/50
GV2 ME10	Integrated	4/6.3									50/50	50/50
GV2 ME14	Integrated	6/10									50/50	50/50
GV2 ME16	Integrated	9/14									50/50	50/50
GV2 ME20	Integrated	13/18									50/50	50/50
GV2 ME21	Integrated	17/23									50/50	50/50
GV2 ME22	Integrated	20/25									50/50	50/50
GV2 ME32	Integrated	24/32									50/50	50/50

Upstream	NSX160B	NSX160F	NSX160F
Breaking capacity	25 kA	36 kA	50/70/100/150 kA
Trip unit	Micrologic		

Downst.	Thermal relay	Rating (A)	160	160	160
GV2 ME01	Integrated	0.1/0.16	25/25	36/36	50/50
GV2 ME02	Integrated	0.16/0.25	25/25	36/36	50/50
GV2 ME03	Integrated	0.25/0.40	25/25	36/36	50/50
GV2 ME04	Integrated	0.40/0.63	25/25	36/36	50/50
GV2 ME05	Integrated	0.63/1	25/25	36/36	50/50
GV2 ME06	Integrated	1/1.6	25/25	36/36	50/50
GV2 ME07	Integrated	1.6/2.5	25/25	36/36	50/50
GV2 ME08	Integrated	2.5/4	25/25	36/36	50/50
GV2 ME10	Integrated	4/6.3	25/25	36/36	50/50
GV2 ME14	Integrated	6/10	25/25	36/36	50/50
GV2 ME16	Integrated	9/14	25/25	36/36	50/50
GV2 ME20	Integrated	13/18	25/25	36/36	50/50
GV2 ME21	Integrated	17/23	25/25	36/36	50/50
GV2 ME22	Integrated	20/25	25/25	36/36	50/50
GV2 ME32	Integrated	24/32	25/25	36/36	50/50

Note: respect the basic rules of selectivity, in terms of overload, short-circuit, ground fault and earth leakage when applicable see page A-2, or check curves with Schneider Electric online "Electrical calculation tools".

## Selectivity enhanced by cascading

Upstream: Compact NSX160

Downstream: GV2 P

Ue: 380-415 V AC

Upstream	NSX160H	NSX160S
Breaking capacity	70 kA	100 kA
Trip unit	TM-D	

Downst.	Thermal relay	Rating (A)	80	100	125	160	80	100	125	160
GV2 P01	Integrated	0.1/0.16	70/70	70/70	70/70	70/70	100/100	100/100	100/100	100/100
GV2 P02	Integrated	0.16/0.25	70/70	70/70	70/70	70/70	100/100	100/100	100/100	100/100
GV2 P03	Integrated	0.25/0.40	70/70	70/70	70/70	70/70	100/100	100/100	100/100	100/100
GV2 P04	Integrated	0.40/0.63	70/70	70/70	70/70	70/70	100/100	100/100	100/100	100/100
GV2 P05	Integrated	0.63/1	70/70	70/70	70/70	70/70	100/100	100/100	100/100	100/100
GV2 P06	Integrated	1/1.6	70/70	70/70	70/70	70/70	100/100	100/100	100/100	100/100
GV2 P07	Integrated	1.6/2.5	70/70	70/70	70/70	70/70	100/100	100/100	100/100	100/100
GV2 P08	Integrated	2.5/4			70/70	70/70	100/100	100/100	100/100	100/100
GV2 P10	Integrated	4/6.3			70/70	70/70	100/100	100/100	100/100	100/100
GV2 P14	Integrated	6/10			70/70	70/70	100/100	100/100	100/100	100/100
GV2 P16	Integrated	9/14			70/70	70/70	100/100	100/100	100/100	100/100
GV2 P20	Integrated	13/18			70/70	70/70	100/100	100/100	100/100	100/100
GV2 P21	Integrated	17/23			70/70	70/70	100/100	100/100	100/100	100/100
GV2 P22	Integrated	20/25			70/70	70/70	100/100	100/100	100/100	100/100

Upstream	NSX160L	NSX160H	NSX160S	NSX160L
Breaking capacity	150 kA	70 kA	100 kA	150 kA
Trip unit	TM-D	Micrologic		

Downst.	Thermal relay	Rating (A)	80	100	125	160	160	160	160
GV2 P01	Integrated	0.1/0.16	150/150	150/150	150/150	150/150	70/70	100/100	150/150
GV2 P02	Integrated	0.16/0.25	150/150	150/150	150/150	150/150	70/70	100/100	150/150
GV2 P03	Integrated	0.25/0.40	150/150	150/150	150/150	150/150	70/70	100/100	150/150
GV2 P04	Integrated	0.40/0.63	150/150	150/150	150/150	150/150	70/70	100/100	150/150
GV2 P05	Integrated	0.63/1	150/150	150/150	150/150	150/150	70/70	100/100	150/150
GV2 P06	Integrated	1/1.6	150/150	150/150	150/150	150/150	70/70	100/100	150/150
GV2 P07	Integrated	1.6/2.5	150/150	150/150	150/150	150/150	70/70	100/100	150/150
GV2 P08	Integrated	2.5/4			150/150	150/150	70/70	100/100	150/150
GV2 P10	Integrated	4/6.3			150/150	150/150	70/70	100/100	150/150
GV2 P14	Integrated	6/10			150/150	150/150	70/70	100/100	150/150
GV2 P16	Integrated	9/14			150/150	150/150	70/70	100/100	150/150
GV2 P20	Integrated	13/18			150/150	150/150	70/70	100/100	150/150
GV2 P21	Integrated	17/23			150/150	150/150	70/70	100/100	150/150
GV2 P22	Integrated	20/25			150/150	150/150	70/70	100/100	150/150

**Note:** respect the basic rules of selectivity, in terms of overload, short-circuit, ground fault and earth leakage when applicable see page A-2, or check curves with Schneider Electric online "Electrical calculation tools".

## Selectivity enhanced by cascading

Upstream: Compact NSX160

Downstream: GV2 L

Ue: 380-415 V AC

Upstream	NSX160H	NSX160S
Breaking capacity	70 kA	100 kA
Trip unit	TM-D	

Downst.	Thermal relay	Rating (A)	80	100	125	160	80	100	125	160
GV2 L03	LR2 D13 03	0.25/0.40	70/70	70/70	70/70	70/70	100/100	100/100	100/100	100/100
GV2 L04	LR2 D13 04	0.40/0.63	70/70	70/70	70/70	70/70	100/100	100/100	100/100	100/100
GV2 L05	LR2 D13 05	0.63/1	70/70	70/70	70/70	70/70	100/100	100/100	100/100	100/100
GV2 L06	LR2 D13 06	1/1.6	70/70	70/70	70/70	70/70	100/100	100/100	100/100	100/100
GV2 L07	LR2 D13 07	1.6/2.5	70/70	70/70	70/70	70/70	100/100	100/100	100/100	100/100
GV2 L08	LR2 D13 08	2.5/4			70/70	70/70	100/100	100/100	100/100	100/100
GV2 L10	LR2 D13 10	4/6.3			70/70	70/70	100/100	100/100	100/100	100/100
GV2 L14	LR2 D13 14	7/10			70/70	70/70	100/100	100/100	100/100	100/100
GV2 L16	LR2 D13 16	9/13			70/70	70/70	100/100	100/100	100/100	100/100
GV2 L20	LR2 D13 21	12/18			70/70	70/70	100/100	100/100	100/100	100/100
GV2 L22	LR2 D13 22	17/25			70/70	70/70	100/100	100/100	100/100	100/100

Upstream	NSX160L	NSX160H	NSX160S	NSX160L
Breaking capacity	150 kA	70 kA	100 kA	150 kA
Trip unit	TM-D	Micrologic		

Downst.	Thermal relay	Rating (A)	80	100	125	160	160	160	160
GV2 L03	LR2 D13 03	0.25/0.40	150/150	150/150	150/150	150/150	70/70	100/100	150/150
GV2 L04	LR2 D13 04	0.40/0.63	150/150	150/150	150/150	150/150	70/70	100/100	150/150
GV2 L05	LR2 D13 05	0.63/1	150/150	150/150	150/150	150/150	70/70	100/100	150/150
GV2 L06	LR2 D13 06	1/1.6	150/150	150/150	150/150	150/150	70/70	100/100	150/150
GV2 L07	LR2 D13 07	1.6/2.5	150/150	150/150	150/150	150/150	70/70	100/100	150/150
GV2 L08	LR2 D13 08	2.5/4			150/150	150/150	70/70	100/100	150/150
GV2 L10	LR2 D13 10	4/6.3			150/150	150/150	70/70	100/100	150/150
GV2 L14	LR2 D13 14	7/10			150/150	150/150	70/70	100/100	150/150
GV2 L16	LR2 D13 16	9/13			150/150	150/150	70/70	100/100	150/150
GV2 L20	LR2 D13 21	12/18			150/150	150/150	70/70	100/100	150/150
GV2 L22	LR2 D13 22	17/25			150/150	150/150	70/70	100/100	150/150

**Note:** respect the basic rules of selectivity, in terms of overload, short-circuit, ground fault and earth leakage when applicable see page A-2, or check curves with Schneider Electric online "Electrical calculation tools".

# Selectivity enhanced by cascading

Upstream: Compact NSX160, NSX250, NSX400

Downstream: LUB12, LUB32

Ue: 440 V AC

Upstream	NSX160H	NSX160S	NSX160L	NSX250H	NSX250S	NSX250L
Breaking capacity	65 kA	90 kA	130 kA	65 kA	90 kA	130 kA
Trip unit	TM-D					

Downst.	Thermal relay	Rating (A)	80/100	125/160	80/100	125/160	80/100	125/160	160	200/250	160	200/250	160	200/250
LUB12	LUC $\bullet$ X6	0.15/0.6		65/65		90/90		130/130	65/65	65/65	90/90	90/90	100/100	100/100
	LUC $\bullet$ 1X	0.35/1.4		65/65		90/90		130/130	65/65	65/65	90/90	90/90	100/100	100/100
	LUC $\bullet$ 05	1.25/5		65/65		90/90		130/130	65/65	65/65	90/90	90/90	100/100	100/100
	LUC $\bullet$ 12	3/12		65/65		90/90		130/130	65/65	65/65	90/90	90/90	100/100	100/100
LUB32	LUC $\bullet$ X6	0.15/0.6		5/65		5/90		5/130	5/65	65/65	5/90	90/90	5/100	100/100
	LUC $\bullet$ 1X	0.35/1.4		5/65		5/90		5/130	5/65	65/65	5/90	90/90	5/100	100/100
	LUC $\bullet$ 05	1.25/5		5/65		5/90		5/130	5/65	65/65	5/90	90/90	5/100	100/100
	LUC $\bullet$ 12	3/12		5/65		5/90		5/130	5/65	65/65	5/90	90/90	5/100	100/100
	LUC $\bullet$ 18	4.5/18		5/65		5/90		5/130	5/65	65/65	5/90	90/90	5/100	100/100
	LUC $\bullet$ 32	8/32		5/65		5/90		5/130	5/65	65/65	5/90	90/90	5/100	100/100

Upstream	NSX160H	NSX160S	NSX160L	NSX250H	NSX250S	NSX250L	NSX400H	NSX400L
Breaking capacity	65 kA	90 kA	130 kA	65 kA	90 kA	130 kA	65 kA	90 kA
Trip unit	Micrologic							

Downst.	Thermal relay	Rating (A)	160	160	160	250	250	250	400	400
LUB12	LUC $\bullet$ X6	0.15/0.6	65/65	90/90	130/130	65/65	90/90	100/100		
	LUC $\bullet$ 1X	0.35/1.4	65/65	90/90	130/130	65/65	90/90	100/100		
	LUC $\bullet$ 05	1.25/5	65/65	90/90	130/130	65/65	90/90	100/100		
	LUC $\bullet$ 12	3/12	65/65	90/90	130/130	65/65	90/90	100/100		
LUB32	LUC $\bullet$ X6	0.15/0.6	5/65	5/90	5/130	65/65	90/90	100/100		
	LUC $\bullet$ 1X	0.35/1.4	5/65	5/90	5/130	65/65	90/90	100/100		
	LUC $\bullet$ 05	1.25/5	5/65	5/90	5/130	65/65	90/90	100/100		
	LUC $\bullet$ 12	3/12	5/65	5/90	5/130	65/65	90/90	100/100		
	LUC $\bullet$ 18	4.5/18	5/65	5/90	5/130	65/65	90/90	100/100		
	LUC $\bullet$ 32	8/32	5/65	5/90	5/130	65/65	90/90	100/100		

**Note:** respect the basic rules of selectivity, in terms of overload, short-circuit, ground fault and earth leakage when applicable see page A-2, or check curves with Schneider Electric online "Electrical calculation tools".



# Motor protection coordination

## Protection of motor circuit with circuit-breaker

### Introduction

A circuit supplying a motor may include one, two, three or four switchgear or controlgear devices fulfilling one or more functions.

**When a number of devices are used, they must be coordinated to ensure optimum operation of the motor.**

Protection of a motor circuit involves a number of parameters that depend on:

- the application (type of machine driven, operating safety, starting frequency, etc.)
- the level of service continuity imposed by the load or the application
- the applicable standards to ensure protection of life and property.

The necessary electrical functions are of very different natures:

- protection (motor-dedicated for overloads)
- control (generally with high endurance levels)
- isolation.

### Protection functions

#### Disconnection functions:

- Isolate a motor circuit prior to maintenance operations.

#### Short-circuit protection:

Protect the starter and the cables against major overcurrents ( $> 10 I_n$ ).

#### Control:

Start and stop the motor, and, if applicable:

- gradual acceleration
- speed control.

#### Overload protection:

Protect the starter and the cables against minor overcurrents ( $< 10 I_n$ ).

#### Additional specific protection:

- limitative fault protection (while the motor is running)
- preventive fault protection (monitoring of motor insulation with motor off).

#### Overloads ( $I < 10 I_n$ ).

An overload may be caused by:

- an electrical problem, for instance on the mains (loss of a phase, voltage outside tolerances, etc.)
- a mechanical problem, for instance excessive torque due to abnormally high demands by the process or motor damage (bearing vibrations, etc.)

A further consequence of these two origins is excessively long starting.

#### Impedant short-circuit ( $10 < I < 50 I_n$ )

Deterioration of motor-winding insulation is the primary cause.

#### Short-circuit ( $I > 50 I_n$ )

This type of fault is relatively rare. A possible cause may be a connection error during maintenance.

#### Overload protection

Thermal relays provide protection against this type of fault. They may be:

- integrated in the short-circuit protective device
- separate.

#### Short-circuit protection

This type of protection is provided by a circuit breaker.

#### Protection against insulation faults

This type of protection may be provided by:

- a residual current device (RCD)
- an insulation monitoring device (IMD).

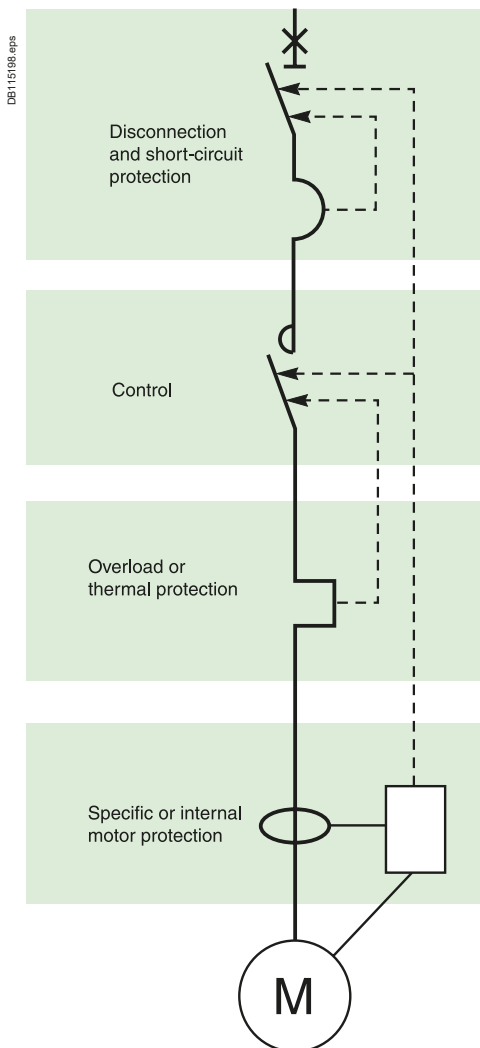

# Motor protection coordination

## Protection of motor circuit with circuit-breaker

B

### Applicable standards

A circuit supplying a motor must comply with the general rules set out in IEC standard 60947-4-1 and in particular with those concerning contactors, motor starters and their protection as stipulated in IEC 60947-4-1, notably:

- coordination of the components of the motor circuit
- trip class for thermal relays
- contactor utilisation categories
- coordination of insulation.

### Coordination of the components of the motor circuit

#### Two types of coordination

The standard defines tests at different current levels. The purpose of these tests is to place the switchgear and controlgear in extreme conditions. Depending on the state of the components following the tests, the standard defines two types of coordination:

##### ■ type 1:

Deterioration of the contactor and the relay is acceptable under two conditions:

- no danger to operating personnel
- no danger to any components other than the contactor and the relay

##### ■ type 2:

Only minor welding of the contactor or starter contacts is permissible and the contacts must be easily separated.

- following type-2 coordination tests, the switchgear and controlgear functions must be fully operational.

#### Which type of coordination is needed?

Selection of a type of coordination depends on the operating conditions encountered.

The goal is to achieve the best balance between the user's needs and the cost of the installation.

##### ■ type 1:

- qualified maintenance service
- low cost of switchgear and controlgear
- continuity of service is not imperative or may be ensured by simply replacing the faulty motor drawer

##### ■ type 2:

- continuity of service is imperative
- limited maintenance service
- specifications stipulating type 2.

# Motor protection coordination

## Protection of motor circuit with circuit-breaker

### The different test currents

#### "Ic", "r" and "Iq" test currents

To qualify for type-2 coordination, the standard requires three fault-current tests to check that the switchgear and controlgear operates correctly under overload and short-circuit conditions.

#### "Ic" current (overload $I < 10 I_n$ )

The thermal relay provides protection against this type of fault, up to the  $I_c$  value (a function of  $I_m$  or  $I_{sd}$ ) defined by the manufacturer.

IEC standard 60947-4-1 stipulates two tests that must be carried out to guarantee coordination between the thermal relay and the short-circuit protective device:

- at  $0.75 I_c$ , only the thermal relay reacts
- at  $1.25 I_c$ , the short-circuit protective device reacts.

Following the tests at  $0.75 I_c$  and  $1.25 I_c$ , the trip characteristics of the thermal relay must be unchanged. Type-2 coordination thus enhances continuity of service. The contactor may be closed automatically following clearing of the fault.

#### "r" current

(Impedant short-circuit  $10 < I < 50 I_n$ )

The primary cause of this type of fault is the deterioration of insulation. IEC standard 60947-4-1 defines an intermediate short-circuit current "r". This test current is used to check that the protective device provides protection against impedant short-circuits.

There must be no modification in the original characteristics of the contactor and the thermal relay following the test.

The circuit breaker must trip in  $\leq 10$  ms for a fault current  $\geq 15 I_n$ .

Operational current $I_e$ (AC3) of the motor (in A)	"r" current (kA)
$I_e \leq 16$	1
$16 < I_e \leq 63$	3
$63 < I_e \leq 125$	5
$125 < I_e \leq 315$	10
$315 < I_e < 630$	18

#### "Iq" current

(short-circuit  $I > 50 I_n$ )

This type of fault is relatively rare. A possible cause may be a connection error during maintenance.

Short-circuit protection is provided by devices that open quickly.

IEC standard 60947-4-1 defines the "Iq" current as generally  $\geq 50$  kA.

The "Iq" current is used to check the coordination of the switchgear and controlgear installed on a motor supply circuit.

Following this test under extreme conditions, all the coordinated switchgear and controlgear must remain operational.

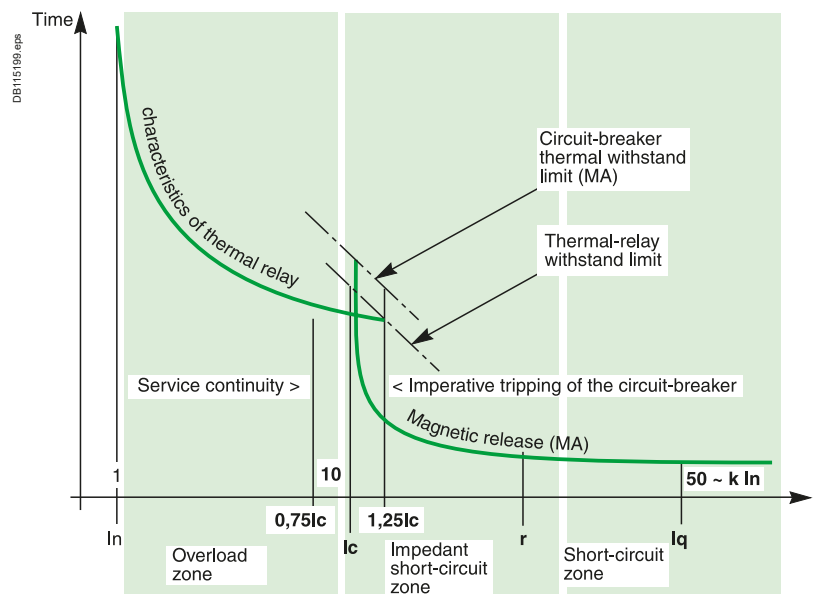

# Motor protection coordination

## Protection of motor circuit with circuit-breaker

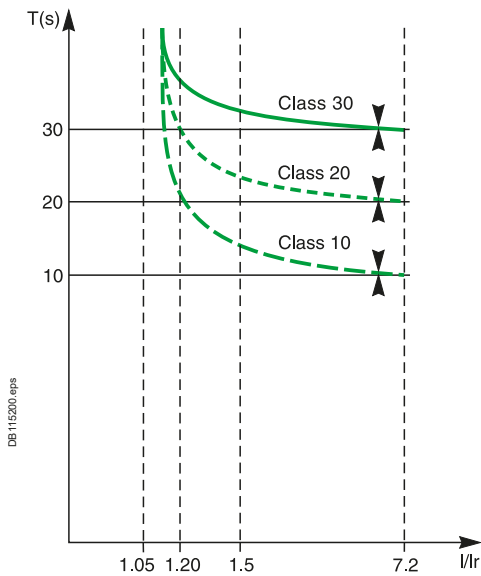

Trip class of a thermal relay.

### Trip class of a thermal relay

The four trip class of a thermal relay are 10 A, 10, 20 and 30 (maximum tripping times at 7.2 Ir).

Classes 10 and 10 A are the most commonly used. Classes 20 and 30 are reserved for motors with difficult starting conditions.

The diagram and the table opposite can be used to select a thermal relay suited to the motor starting time.

Class	1.05 Ir	1.2 Ir	1.5 Ir	7.2 Ir
10 A	$t > 2 \text{ h}$	$t < 2 \text{ h}$	$t < 2 \text{ min.}$	$2 \leq t \leq 10 \text{ s}$
10	$t > 2 \text{ h}$	$t < 2 \text{ h}$	$t < 4 \text{ min.}$	$4 \leq t \leq 10 \text{ s}$
20	$t > 2 \text{ h}$	$t < 2 \text{ h}$	$t < 8 \text{ min.}$	$6 \leq t \leq 20 \text{ s}$
30	$t > 2 \text{ h}$	$t < 2 \text{ h}$	$t < 12 \text{ min.}$	$9 \leq t \leq 30 \text{ s}$

# Motor protection coordination

## Protection of motor circuit with circuit-breaker

### The four utilisation categories of contactors (AC1 to AC4)

The four utilisation categories of contactors (AC1 to AC4) determine the operating frequency and endurance of a contactor. The category depends on the type of load. If the load is a motor, the category also depends on the service classification.

#### Main characteristics of the controlled electrical circuits and applications

Category	Type of load	Contactor usage	Typical applications
AC1	No-inductive ( $\cos \varphi 0.8$ )	Energisation	Heating, distribution
AC2	Slip-ring motors ( $\cos \varphi 0.65$ )	Starting Switching off during running Regenerative braking Inching	Wire drawing machines
AC3	Squirrel-cage motors ( $\cos \varphi 0.45$ for $I_e \leq 100A$ ) ( $\cos \varphi 0.35$ for $I_e > 100A$ )	Starting Switching off during running	Compressors, lifts, mixing Pumps, escalators, fans, Conveyers, air-conditioning
AC4	Squirrel-cage motors ( $\cos \varphi 0.45$ for $I_e \leq 100A$ ) ( $\cos \varphi 0.35$ for $I_e > 100A$ )	Starting Switching off during running Regenerative braking Plugging Inching	Printing machines, wire

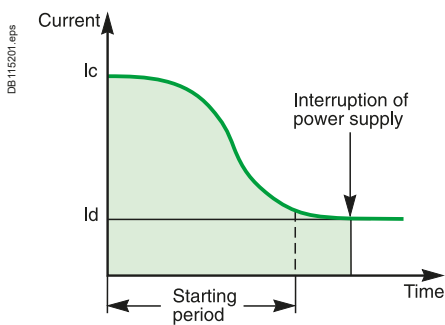

AC3 utilisation category. The contactor interrupts the rated current of the motor.

#### AC3 utilisation category

This category covers asynchronous squirrel-cage motors that are switched off during running. This is the most common situation (85 % of all cases).

The control device establishes the starting current and interrupts the rated current at a voltage equal to approximately one-sixth of the rated value.

Current interruption is carried out with no difficulty.

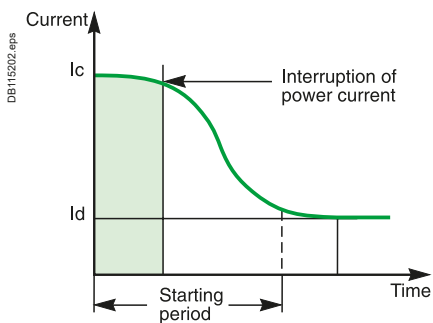

AC4 utilisation category. The contactor must be capable of interrupting the starting current  $I_d$ .

#### AC4 utilisation category

This category covers asynchronous squirrel-cage or slip-ring motors capable of operating under regenerative-braking or inching (jogging) conditions.

The control device establishes the starting current and is capable of interrupting the starting current at a voltage that may be equal to that of the mains.

Such difficult conditions require oversizing of the control and protective devices with respect to category AC3.

# Motor protection coordination

Using the circuit breaker/contactors coordination tables



## Subtransient phenomena related to direct on-line starting of asynchronous motors

Subtransient phenomena occurring when starting squirrel-cage motors:  
A squirrel-cage motor draws a high inrush current during starting. This current is related to the combined influence of two parameters:

- the high inductance of the copper stator winding
- the magnetisation of the iron core of the stator.

In motor: current drawn by the motor at full rated load (in A rms)

$I_d$ : current drawn by the motor during starting (in A rms)

$I_d''$ : subtransient current generated by the motor when it is energised.  
This very short subtransient phenomenon is expressed as  $k \times I_d \times r^2$  (in A peak).

$t_d$ : motor starting time, from 0.5 to 30 seconds depending on the application.

$t_d''$ : duration of the subtransient current, from 0.010 to 0.015 seconds when the motor is energised.

$I_{rm}$ : magnetic setting of the circuit breakers.

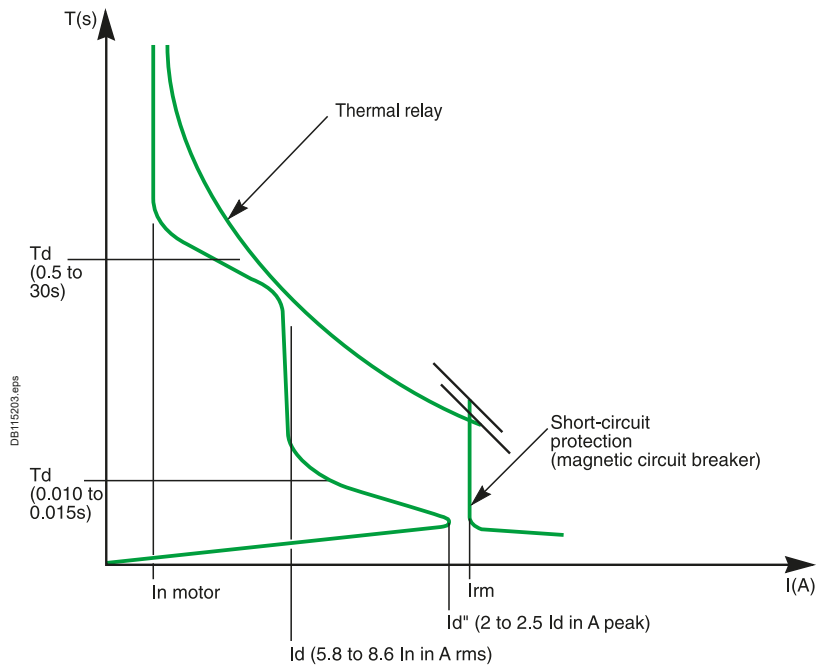

### Typical upper and lower limits for these subtransient currents:

These values, not covered by standards, also depend on the type of motor technology used:

- ordinary motors  $I_d'' = 2 I_d$  to  $2.1 I_d$  (in A peak)
- high-efficiency motors  $I_d'' = 2.2 I_d$  to  $2.5 I_d$  (in A peak).
- variation of  $I_d''$  as a function of  $I_d$ :

Type of motor	$I_d$ (in A rms)	$I_d''$ (in A peak)
Ordinary motor	5.8 to 8.6 $I_n$ motor	$I_d'' = 2 I_d = 11.5 I_n$ (A peak) to $I_d'' = 2.1 I_d = 18 I_n$ (A peak)
High-efficiency motor	5.8 to 8.6 $I_n$ motor	$I_d'' = 2.2 I_d = 12.5 I_n$ (A peak) to $I_d'' = 2.5 I_d = 21.5 I_n$ (A peak)

**Example:** Upon energisation, a high-efficiency motor with an  $I_d$  of 7.5  $I_n$  produces a subtransient current with a value between (depending on its characteristics):

- minimum =  $16.5 I_n$  (in A peak)
- maximum =  $18.8 I_n$  (in A peak).

# Motor protection coordination

## Using the circuit breaker/contactors coordination tables

### Subtransient currents and protection settings:

- as illustrated in the above table, subtransient currents can be very high.
- If they approach their upper limits, they can trip short-circuit protection devices (nuisance tripping)
- circuit breakers are rated to provide optimum short-circuit protection for motor starters (type 2 coordination with thermal relay and contactor)
- combinations made up of circuit breakers and contactors and thermal relays are designed to allow starting of motors generating high subtransient currents (up to 19  $I_n$  motor peak)
- the tripping of short-circuit protective devices when starting with a combination listed in the coordination tables means:
  - the limits of certain devices may be reached
  - the use of the starter under type 2 coordination conditions on the given motor may lead to premature wear of one of the components of the combination.

**In event of such a problem, the ratings of the starter and the associated protective devices must be redesigned.**

European regulation EC640 has been introduced in January 2015 to enforce usage of premium efficiency motor classified as IE3.

One consequence of the improvement of induction motor's efficiency may be an increase of starting current value.

TeSys and Compact ranges can handle IE3 motor higher inrush and starting current. However, due to the spread of starting current values of the motors on the market, it's recommended to check the value of subtransient starting current in Direct-On-Line application when  $I_{start} > 7.5 I_n$  or  $I_{peak} \text{ inrush} > 19 \times I_n$ .

### Using the coordination tables for circuit breaker and contactors:

#### ■ ordinary motor:

The starter components can be selected directly from the coordination tables, whatever the values of the starting current ( $I_d$  from 5.8 to 8.6  $I_n$ ) and the subtransient current

#### ■ high-efficiency motors with $I_d \leq 7.5 I_n$ :

The starter components can be selected directly from the coordination tables, whatever the values of the starting current and the subtransient current

#### ■ high-efficiency motors with $I_d > 7.5 I_n$ :

When circuit breakers are used for motor currents in the neighbourhood of their rated current, they are set to provide minimum short-circuit protection at **19  $I_n$  motor (A peak)**.

There are two possibilities:

- the subtransient starting current is known (indicated by the motor manufacturer) and is less than **19  $I_n$  motor (A peak)**.

In this case, the starter components can be selected directly from the coordination tables, whatever the value of the starting current (for  $I_d > 7.5 I_n$ ).

Example: for a 110 kW 380-415 V 3-phase motor, the selected components are: NSX250-MA220/LC1-F225/LR9-F5371.

- the subtransient starting current is unknown or greater than 19  $I_n$  motor (A peak).

In this case, the value used for the motor power in the coordination tables should be increased by 20 % to satisfy optimum starting and coordination conditions.

Example: for a 110 kW 380-415 V 3-phase motor, the selected components are those for a motor power of  $110 + 20 \% = 132 \text{ kW}$ : NSX400 Micrologic 4.3M/LC1-F265/LR9-F5371

### Reversing starters and coordination

The starter components can be selected using the tables for direct-on-line starting. Replace contactors LC1 by LC2.

### Star-delta starting and coordination

- the components should be sized according to the current flowing in the motor windings
- the mounting locations and connections of the various components of star-delta starters should be selected according to the type of coordination required and the protective devices implemented.

# Motor protection coordination

Using the circuit breaker/contactor coordination tables

B

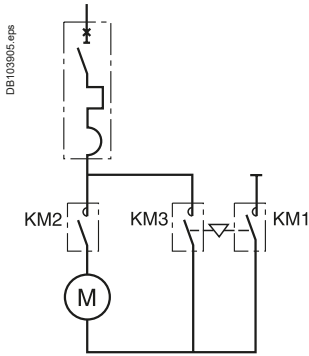

Solution with thermal-magnetic motor circuit breaker.

## Star-delta starting and type 1 coordination

Contactors KM2 and KM3 are sized for the line current divided by 3, however, for the sake of homogeneity, it is often identical to contactors KM2 and KM3.

**The starter components are selected from the special star-delta type 1 coordination tables.**

**Example:** consider the following case:

- 45 kW motor supplied at 380 V
- star-delta starting
- separate thermal relay
- short-circuit current of 20 kA at the starter
- type 1 coordination.

The starter components are selected using the table on page 557E4505.indd/8:

- circuit breaker: NSX100N-MA 100
- contactor: LC3-D50
- thermal relay: LR2-D3357.

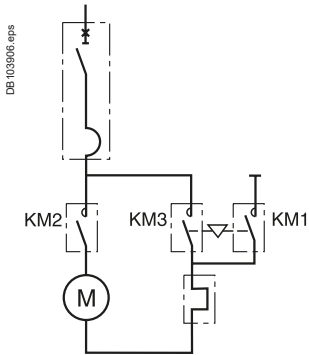

Solution with magnetic motor circuit breaker.

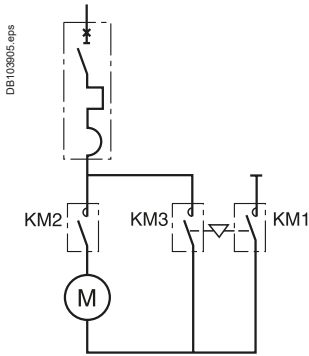

Solution with thermal-magnetic motor circuit breaker.

## Star-delta starting and type 2 coordination

Contactors KM1, KM2 and KM3 are sized for the line current.

**The starter components are selected from the direct-on-line type 2 coordination tables.**

**Example:** consider the following case:

- 55 kW motor supplied at 415 V
- star-delta starting
- thermal protection built into the circuit breaker providing short-circuit protection
- short-circuit current of 45 kA at the starter
- type 2 coordination.

The starter components are selected using the table on page 189:

- circuit breaker: NSX160H with Micrologic 6.2
- starter: LC1-F115 to be replaced by LC3-F115.

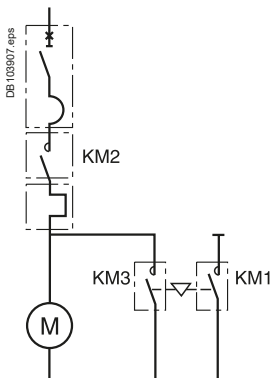

Solution with magnetic motor circuit breaker.



# Motor protection coordination

## Using the circuit breaker/contactor coordination tables

### Starting class and thermal relays

The following tables correspond to "normal" motor starting times. The associated thermal relays are either class 10 or 10 A (tripping time < 10 s).

- for motors with long starting times, the class 10 or 10 A thermal relays must be replaced with class 20 thermal relays as indicated in the correspondence table opposite (for type 1 and type 2 coordination)
- long starting times requiring a class 30 relay:
- apply a derating coefficient (K = 0.8) to the circuit breaker and the contactor
- coordination tables with the multifunction protective relay LT6-P
- three types of multifunction relays (see the corresponding catalogue for detailed characteristics) are available. They may be connected:
  - directly to the motor power supply line
  - to the secondary winding of the current transformer.

The characteristics of the current transformers are the following (as defined by IEC 44-1/44-3):

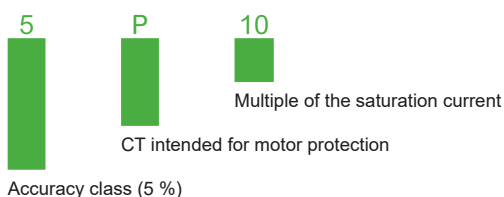

The current transformer ratings must be 5 VA per phase.

Relay		Rating Direct	Connecting Using current trans.
LTM R08	0.4 to 8 A	■	■
LTM R27	1.35 to 27 A	■	
LTM R100	5 to 100 A	■	

Correspondence table class 10 A and class 20 relay			
Contactor series D	Thermal relay Class10/10 A	Class 20	Setting range
LC1-D09-D38	LRD 05	LRD 05L	0.63...1
	LRD 06	LRD 06L	1...1.6
	LRD 07	LRD 07L	1.6...2.5
	LRD 08	LRD 08L	2.5...4
	LRD 10	LRD 10L	4...6
	LRD 12	LRD 12L	5.5...8
LC1-D12-D38	LRD 14	LRD 14L	7...10
	LRD 16	LRD 16L	9...13
LC1-D18-D38	LRD 21	LRD 21L	12...18
LC1-D25-D38	LRD 22	LRD 22L	17...25
	LRD 32	LRD 32L	23...32
LC1-D32-D38	LRD 35		30...38
D40A - D65A	LRD 313	LRD 313L	9 ... 13
	LRD 318	LRD 318L	12 ... 18
	LRD 325	LRD 325L	17 ... 25
	LRD 332	LRD 332L	23 ... 32
	LRD 340	LRD 340L	30 ... 40
	LRD 350	LRD 350L	37 ... 50
	LRD 365	LRD 365L	38 ... 65
D80 - D95	LRD 3322	LR2 D3522	17 ... 25
	LRD 3353	LR2 D3553	23 ... 32
	LRD 3355	LR2 D3555	30 ... 40
	LRD 3357	LR2 D3557	37 ... 50
	LRD 3359	LR2 D3559	48 ... 65
	LRD 3361	LR2 D3561	55 ... 70
	LRD 3363	LR2 D3563	63 ... 80
D115-D150	LRD 3365		80 ... 104
	LR9 D5367	LR9D 5567	60 ... 100
F115-F185	LR9 D5369	LR9D 5569	90 ... 150
	LR9 F53 57	LR9 F55 57	30...50
	LR9 F53 63	LR9 F55 63	48...80
	LR9 F53 67	LR9 F55 67	60...100
	LR9 F53 69	LR9 F55 69	90...150
F185-F400	LR9 F53 71	LR9 F55 71	132...220
F225-F500	LR9 F73 75	LR9 F75 75	200...330
	LR9 F73 79	LR9 F75 79	300...500
F400-F800	LR9 F73 81	LR9 F75 81	380...630

[1] Independant mounting with LAD 7B105.



# Type 2 coordination (IEC 60947-4-1)

Ue: 220-240 V AC

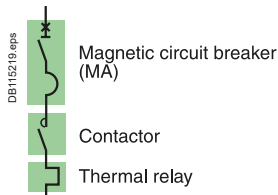

## Circuit breakers, contactors and thermal relays

### Performance "Iq" (kA): U = 220-240V

Circuit breaker	B	F	N	H	S	L
GV4L & LE 02 - 12	-	-	100	-	120 [4]	-
GV4L & LE 25 - 115	50	-	100	-	120 [4]	-
NSX100/160/250-MA	-	85	90	100	120	150
NSX400/630-Micrologic 1.3M	-	85	90	100	120	150
NS800L/NS1000L micrologic 5.0	-	-	-	-	-	150

Starting [1]: normal LRD class 10 A, LR9 class 10.

Motors P (kW)	Guide values of operational current in amps at :				Circuit breakers			Contactors [2]		Thermal o/l relays	
	220V (A)	230V (A)	240V (A)	Ie max (A)	Type	rat(A)	Irm(A)	Type	Type	Irth [3]	
0.09	0.54	0.52	0.50	1	GV4L or GV4LE	2	14	LC1-D09	LRD-05	0.63/1	
0.12	0.73	0.7	0.67	1	GV4L or GV4LE	2	14	LC1-D09	LRD-05	0.63/1	
0.18	1.05	1	0.96	1.6	GV4L or GV4LE	2	22	LC1-D09	LRD-06	1/1.6	
0.25	1.57	1.5	1.44	1.6	GV4L or GV4LE	2	22	LC1-D09	LRD-06	1/1.6	
0.37	2.0	1.9	1.82	2.5	GV4L or GV4LE	3.5	35	LC1-D09	LRD-07	1.6/2.5	
0.55	2.7	2.6	2.5	3	GV4L or GV4LE	3.5	42	LC1-D32	LRD-08	2.5/4	
0.75	3.5	3.3	3.2	4	GV4L or GV4LE	7	56	LC1-D32	LRD-08	2.5/4	
1.1	4.9	4.7	4.5	6	GV4L or GV4LE	7	84	LC1-D32	LRD-10	4/6	
1.5	6.6	6.3	6.0	7	GV4L or GV4LE	7	91	LC1-D40A	LRD-12 [3]	5.5/8	
2.2	8.9	8.5	8.1	10	GV4L or GV4LE	12.5	138	LC1-D40A	LRD-14 [3]	7 /10	
3	11.8	11.3	10.8	12.5	GV4L or GV4LE	12.5	163	LC1-D40A	LRD313	9/13	
4	15.7	15	14.4	18	GV4L or GV4LE	25	250	LC1-D40A	LRD318	12/18	
					NSX100-MA	25	250	LC1-D80	LRD 3321	12/18	
5.5	20.9	20	19.2	25	GV4L or GV4LE	25	325	LC1-D40A	LRD325	17/25	
					NSX100-MA	25	325	LC1-D80	LRD 3322	17/25	
7.5	28.2	27	25.9	32	GV4L or GV4LE	50	450	LC1-D40A	LRD332	23/32	
					NSX100-MA	50	450	LC1-D80	LRD-33 53	23/32	
10	36.1	35	33.1	40	GV4L or GV4LE	50	550	LC1-D50A	LRD340	30/40	
					NSX100-MA	50	550	LC1-D80	LRD-33 55	30/40	
11	40	38	36	50	GV4L or GV4LE	50	650	LC1-D50A	LRD350	37/50	
				40	NSX100-MA	50	550	LC1-D80	LRD-33 55	30/40	
15	53	51	49	65	GV4L or GV4LE	80	880	LC1-D65A	LRD365	48/65	
				63	NSX100-MA	100	700	LC1-D80	LRD-33 59	48/65	
18.5	64	61	58	65	GV4L or GV4LE	80	880	LC1-D65A	LRD365	48/65	
				63	NSX100-MA	100	900	LC1-D80	LRD-33 59	48/65	
22	75	72	69	80	GV4L or GV4LE	80	1040	LC1-D80	LRD-33 63	63/80	
					NSX100-MA	100	1100	LC1-D80	LRD-33 63	63/80	
30	100	96	92	100	NSX100-MA	100	1300	LC1-D115	LR9-D53 67	60/100	
								LC1-F115	LR9-F53 67	60/100	
37	120	115	110	150	NSX160-MA	150	1950	LC1-D150	LR9-D53 69	90/150	
								LC1-F150	LR9-F53 69	90/150	
45	146	140	134	150	NSX160-MA	150	1950	LC1-D150	LR9-D53 69	90/150	
								LC1-F150	LR9-F53 69	90/150	
55	177	169	162	185	NSX250-MA	220	2420	LC1-F185	LR9-F53 71	132/220	
				220	NSX400 - Micrologic 1.3M	320	2880	LC1-F265	LR9-F53 71	132/220	
75	240	230	220	265	NSX400 - Micrologic 1.3M	320	3500	LC1-F265	LR9-F73 75	200/330	
90	291	278	266	320	NSX400 - Micrologic 1.3M	320	4160	LC1-F330	LR9-F73 75	200/330	
110	355	340	326	400	NSX630 - Micrologic 1.3M	500	5700	LC1-F400	LR9-F73 79	300/500	
132	418	400	383	500	NSX630 - Micrologic 1.3M	500	6500	LC1-F500	LR9-F73 79	300/500	
150	477	457	438	500	NSX630 - Micrologic 1.3M	500	6500	LC1-F500	LR9-F73 79	300/500	
160	509	487	467	630	NS800L - Micrologic 5.0 - LR off	800	8000	LC1-F630	LR9-F73 81	380/630	
200	637	609	584	630	NS800L - Micrologic 5.0 - LR off	800	8000	LC1-F630	LR9-F73 81	380/630	
220	700	658	631	700	NS800L - Micrologic 5.0 - LR off	800	9600	LC1-F780 or LC1F1000	TC800/5 + LRD-10	630/1000	
250	782	748	717	800	NS1000L - Micrologic 5.0 - LR off	1000	10000	LC1-F780 or LC1F1000	TC800/5 + LRD-10	630/1000	

[1] For long starting (class 20), see the correspondence table for thermal relay.

[2] Reversers : replace LC1 with LC2 ; start-delta starter : replace LC1 with LC3.

[3] Separate overload relay.

[4] GV4LE only, for GV4 "S" performance with rotary handle, order GV4LE "S" & rotary handle separately.

# Type 2 coordination (IEC 60947-4-1)

U<sub>e</sub>: 220-240 V AC

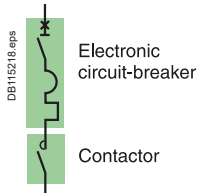

## Circuit breakers, and contactors

### Performance "Iq" (kA): U = 220-240V

Circuit breakers	B	F	N	H	S	L
GV4 P, PE & PEM 02 - 12	-	-	100	-	120 [4]	-
GV4 P, PE & PEM 25 - 115	50	-	100	-	120 [4]	-
NSX100/160/250 Micrologic 2.2M / 6.2M	-	85	90	100	120	150
NSX400/630 Micrologic 2.3M / 6.3M	-	85	90	100	120	150
NS800L/NS1000L Micrologic 5.0	-	-	-	-	-	150

### Starting [1] Standard IEC 60947-4-1

Trip unit normal (classe) long (classe)	GV4P, PE or PEM	Micrologic 2.2M / 2.3M 5. 10	Micrologic 6.2M / 6.3M 5. 10	Micrologic 5.0 10
normal	10	5. 10	5. 10	10
long	20	20	20. 30 [1]	20

Motors P (kW)	Guide values of operational current in amps at :				Circuit breakers			Contactors [2] I <sub>rm</sub> (A) [3]	Thermal o/l relays Type
	220V (A)	230V (A)	240V (A)	I <sub>e</sub> max (A)	Type	trip unit	I <sub>rt</sub> (A)		
0.09	0.54	0.52	0.50	1	GV4P, PE or PEM	2	0.8/2	14	LC1-D25
0.12	0.73	0.7	0.67	1	GV4P, PE or PEM	2	0.8/2	14	LC1-D25
0.18	1.05	1	0.96	1.6	GV4P, PE or PEM	2	0.8/2	22	LC1-D25
0.25	1.57	1.5	1.44	1.6	GV4P, PE or PEM	2	0.8/2	22	LC1-D25
0.37	2.0	1.9	1.82	2.5	GV4P, PE or PEM	3.5	1.4/3.5	42	LC1-D32
0.55	2.7	2.6	2.5	3	GV4P, PE or PEM	3.5	1.4/3.5	42	LC1-D32
0.75	3.5	3.3	3.2	4	GV4P, PE or PEM	7	2.9/7	56	LC1-D50A
1.1	4.9	4.7	4.5	6	GV4P, PE or PEM	7	2.9/7	84	LC1-D50A
1.5	6.6	6.3	6.0	7	GV4P, PE or PEM	7	2.9/7	91	LC1-D50A
2.2	8.9	8.5	8.1	10	GV4P, PE or PEM	12.5	5/12.5	138	LC1-D50A
3	11.8	11.3	10.8	12.5	GV4P, PE or PEM	12.5	5/12.5	163	LC1-D50A
4	15.7	15	14.4	18	NSX100	Micrologic 2.2M or 6.2M	12/25	13I <sub>rt</sub>	LC1-D80
					GV4P, PE or PEM	25	10/25	250	LC1-D65A
					NSX100	Micrologic 2.2M or 6.2M	12/25	13I <sub>rt</sub>	LC1-D80
5.5	20.9	20	19.2	25	GV4P, PE or PEM	25	10/25	250	LC1-D65A
					NSX100	Micrologic 2.2M or 6.2M	12/25	13I <sub>rt</sub>	LC1-D80
					GV4P, PE or PEM	50	20/50	13I <sub>rt</sub>	LC1-D65A
7.5	28.2	27	25.9	50	NSX100	Micrologic 2.2M or 6.2M	25/50	13I <sub>rt</sub>	LC1-D80
					NSX100	Micrologic 2.2M or 6.2M	25/50	13I <sub>rt</sub>	LC1-D80
					NSX100	Micrologic 2.2M or 6.2M	25/50	13I <sub>rt</sub>	LC1-D80
10	36.1	35	33.1	50	GV4P, PE or PEM	50	20/50	13I <sub>rt</sub>	LC1-D65A
					NSX100	Micrologic 2.2M or 6.2M	25/50	13I <sub>rt</sub>	LC1-D80
					NSX100	Micrologic 2.2M or 6.2M	25/50	13I <sub>rt</sub>	LC1-D80
11	40	38	36	50	GV4P, PE or PEM	50	20/50	13I <sub>rt</sub>	LC1-D65A
					NSX100	Micrologic 2.2M or 6.2M	25/50	13I <sub>rt</sub>	LC1-D80
					NSX100	Micrologic 2.2M or 6.2M	25/50	13I <sub>rt</sub>	LC1-D80
15	53	51	49	80	GV4P, PE or PEM	80	40/80	13I <sub>rt</sub>	LC1-D65A
					NSX100	Micrologic 2.2M or 6.2M	50/100	13I <sub>rt</sub>	LC1-D80
					NSX100	Micrologic 2.2M or 6.2M	50/100	13I <sub>rt</sub>	LC1-D80
18.5	64	61	58	80	GV4P, PE or PEM	80	40/80	13I <sub>rt</sub>	LC1-D80
					NSX100	Micrologic 2.2M or 6.2M	50/100	13I <sub>rt</sub>	LC1-D80
					NSX100	Micrologic 2.2M or 6.2M	50/100	13I <sub>rt</sub>	LC1-D80
22	75	72	69	115	GV4P, PE or PEM	115	65/115	13I <sub>rt</sub>	LC1-D115 or LC1-F115
					NSX100	Micrologic 2.2M or 6.2M	50/100	13I <sub>rt</sub>	LC1-D115 or LC1-F115
					NSX100	Micrologic 2.2M or 6.2M	50/100	13I <sub>rt</sub>	LC1-D115 or LC1-F115
30	100	96	92	100	GV4P, PE or PEM	115	65/115	13I <sub>rt</sub>	LC1-D115 or LC1-F115
					NSX100	Micrologic 2.2M or 6.2M	50/100	13I <sub>rt</sub>	LC1-D115 or LC1-F115
					NSX100	Micrologic 2.2M or 6.2M	50/100	13I <sub>rt</sub>	LC1-D115 or LC1-F115
37	120	115	110	150	NSX160	Micrologic 2.2M or 6.2M	70/150	13I <sub>rt</sub>	LC1D150 or LC1-F150
45	146	140	134	150	NSX160	Micrologic 2.2M or 6.2M	70/150	13I <sub>rt</sub>	LC1D150 or LC1-F150
55	177	169	185	185	NSX250	Micrologic 2.2M or 6.2M	100/220	13I <sub>rt</sub>	LC1-F185
					NSX400	Micrologic 2.3M or 6.3M	160/320	13I <sub>rt</sub>	LC1-F185
					NSX400	Micrologic 2.3M or 6.3M	160/320	13I <sub>rt</sub>	LC1-F265
90	291	278	266	320	NSX400	Micrologic 2.3M or 6.3M	160/320	13I <sub>rt</sub>	LC1-F330
110	355	340	326	400	NSX630	Micrologic 2.3M or 6.3M	250/500	13I <sub>rt</sub>	LC1-F400
132	418	400	383	500	NSX630	Micrologic 2.3M or 6.3M	250/500	13I <sub>rt</sub>	LC1-F500
150	448	429	411	500	NSX630	Micrologic 2.3M or 6.3M	250/500	13I <sub>rt</sub>	LC1-F500
160	509	487	467	630	NS800L	Micrologic 5.0	320/800	8000	LC1-F630
200	637	609	584	630	NS800L	Micrologic 5.0	320/800	8000	LC1-F630
220	700	658	631	700	NS800L	Micrologic 5.0	320/800	9600	LC1-F780 or LC1F1000
250	782	748	717	800	NS1000L	Micrologic 5.0	400/1000	10000	LC1-F780 or LC1F1000

[1] For class 30 the contactor rating shall be checked according to 30s thermal withstand (F range).

[2] Reversers : replace LC1 with LC2 ; start-delta starter : replace LC1 with LC3.

[3] li for Micrologic 5.0 control unit.

[4] GV4PE and PEM only, for GV4 "S" performance with rotary handle, order GV4PE, PEM "S" & rotary handle separately.

# Type 2 coordination (IEC 60947-4-1)

Ue: 380-400 V AC

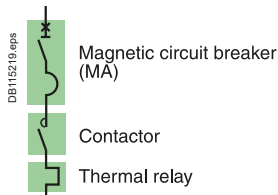

## Circuit breakers, contactors and thermal relays

Performance "Iq" (kA): U = 380-400V

Circuit breaker	B	F	N	H	S	L
GV4L & LE 02 - 12	-	-	50	-	100 [4]	-
GV4L & LE 25 - 115	25	-	50	-	100 [4]	-
NSX100/160/250-MA	-	36	50	70	100	130
NSX400/630-Micrologic 1.3M	-	36	50	70	100	130
NS800L/NS1000L Micrologic 5.0	-	-	-	-	-	130

Starting [1]: normal LRD class 10 A, LR9 class 10.

Motors Rated power P(kW)	Guide values of operational current in amps at :			Circuit breakers			Contactors [2]		Thermal o/l relays	
	380V	400V	Ie max	Type	rat(A)	Irm(A) [3]	Type	Type	Irth [1]	
0.18	0.63	0.6	1	GV4L or GV4LE	2	14	LC1-D09	LRD-05	0.63/1	
0.25	0.89	0.85	1	GV4L or GV4LE	2	14	LC1-D09	LRD-05	0.63/1	
0.37	1.16	1.1	1.6	GV4L or GV4LE	2	22	LC1-D09	LRD-06	1/1.6	
0.55	1.58	1.5	2	GV4L or GV4LE	2	26	LC1-D09	LRD-06	1.6/2.5	
0.75	2.00	1.9	2	GV4L or GV4LE	2	26	LC1-D09	LRD-07	1.6/2.5	
1.1	2.8	2.7	3.5	GV4L or GV4LE	3.5	46	LC1-D25	LRD-08	2.5/4	
1.5	3.8	3.6	7	GV4L or GV4LE	7	56	LC1-D32A + GV1L3	LRD-08	1.6/8	
2.2	5.2	4.9	7	GV4L or GV4LE	7	84	LC1-D32A + GV1L3	LRD-10	1.6/8	
3	6.8	6.5	7	GV4L or GV4LE	7	91	LC1-D40A	LRD-12 [5]	5.5/8	
4	8.9	8.5	10	GV4L or GV4LE	12.5	138	LC1-D65A	LRD-14 [5]	7 / 10	
5.5	12.1	11.5	12.5	GV4L or GV4LE	12.5	163	LC1-D65A	LRD-313	9/13	
7.5	16.3	15.5	18	GV4L or GV4LE	25	250	LC1-D65A	LRD-318	12/18	
10	20	19	25	NSX100-MA	25	250	LC1-D80	LRD 3321	12/18	
				GV4L or GV4LE	25	325	LC1-D65A	LRD-325	17/25	
				NSX100-MA	25	325	LC1-D80	LRD 3322	17/25	
11	23	22	25	GV4L or GV4LE	25	325	LC1-D65A	LRD-325	17/25	
				NSX100-MA	25	450	LC1-D80	LRD 3322	17/25	
				GV4L or GV4LE	50	450	LC1-D65A	LRD-332	23/32	
15	31	29	32	NSX100-MA	50	450	LC1-D80	LRD-33 53	23/32	
				GV4L or GV4LE	50	550	LC1-D65A	LRD-340	30/40	
				NSX100-MA	50	550	LC1-D80	LRD-33 55	30/40	
22	43	41	50	GV4L or GV4LE	50	650	LC1-D65A	LRD-350	37/50	
				NSX100-MA	50	650	LC1-D80	LRD-33 57	37/50	
				GV4L or GV4LE	80	880	LC1-D65A	LRD-365	48/65	
30	58	55	65	NSX100-MA	100	900	LC1-D80	LRD-33 59	48/65	
				GV4L or GV4LE	80	1040	LC1-D80	LRD-33 63	63/80	
				NSX100-MA	100	1100	LC1-D80	LRD-33 63	63/80	
37	69	66	80	GV4L or GV4LE	115	1380	LC1-D115	LR9D-5367	60/100	
				NSX100-MA	100	1300	LC1-F115	LR9-F5367		
				NSX100-MA	100	1300	LC1-D115	LR9-D53 67	60/100	
55	102	97	115	GV4L or GV4LE	115	1495	LC1-F115	LR9-F53 67		
				NSX100-MA	115	1495	LC1-D115	LR9D-5369	90/150	
				NSX160-MA	150	1950	LC1-F115	LR9-F5369	90/150	
75	139	132	150	NSX160-MA	150	1950	LC1-D150	LR9-D53 69	90/150	
				NSX160-MA	150	1950	LC1-F150	LR9-F53 69	90/150	
				NSX250-MA	220	2420	LC1-D150	LR9-D53 69	90/150	
90	168	160	185	NSX250-MA	220	2860	LC1-F185	LR9-F53 71	132/220	
110	205	195	220	NSX400-Micrologic 1.3M	320	3500	LC1-F225	LR9-F53 71	132/220	
				NSX400-Micrologic 1.3M	320	3500	LC1-F265	LR9-F53 71	132/220	
				NSX400-Micrologic 1.3M	320	3500	LC1-F265	LR9-F73 75	200/330	
132	242	230	265	NSX400-Micrologic 1.3M	320	4160	LC1-F330	LR9-F73 75	200/330	
160	295	280	320	NSX630-Micrologic 1.3M	500	5500	LC1-F400 (70kA)	LR9-F73 79	300/500	
				NSX630-Micrologic 1.3M	500	6500	LC1-F500 (130kA)	LR9-F73 79	300/500	
200	368	350	400	NSX630-Micrologic 1.3M	500	6500	LC1-F500	LR9-F73 79	300/500	
				NSX630-Micrologic 1.3M	500	6500	LC1-F500	LR9-F73 79	300/500	
220	400	380	500	NS800L - Micrologic 5.0 - LR off	800	8000	LC1-F630	LR9-F73 81	380/630	
250	453	430	500	NS800L - Micrologic 5.0 - LR off	800	8000	LC1-F630	LR9-F73 81	380/630	
300	526	500	630	NS1000L - Micrologic 5.0 - LR off	1000	10000	LC1-F780 or LC1 F1000	TC800/1 + LRD-05	500/800	
315	568	540	630	NS1000L - Micrologic 5.0 - LR off	1000	10000	LC1-F780 or LC1 F1000	TC800/1 + LRD-05	500/800	
355	642	610	780	NS1000L - Micrologic 5.0 - LR off	1000	10000	LC1-F780 or LC1 F1000	TC800/1 + LRD-05	500/800	
400	726	690	780	NS1000L - Micrologic 5.0 - LR off	1000	10000	LC1-F780 or LC1 F1000	TC800/1 + LRD-05	500/800	
450	789	750	780	NS1000L - Micrologic 5.0 - LR off	1000	10000	LC1-F780 or LC1 F1000	TC800/1 + LRD-05	500/800	
500	895	850	900	NS1000L - Micrologic 5.0 - LR off	1000	10000	LC1-F1000	TC1000/1 + LRD-05	600/1000	

[1] Heavy starting (class 20), see thermal O/L chart of equivalence.

[2] Reversers : replace LC1 with LC2 ; start-delta starter : replace LC1 with LC3.

[3] Ii for Micrologic 5.0 control unit.

[4] GV4LE only, for GV4 "S" performance with rotary handle, order GV4LE "S" & rotary handle separately.

[5] Separate overload Relay, use terminal block LAD7B106.

# Type 2 coordination (IEC 60947-4-1)

U<sub>e</sub>: 380-400 V AC

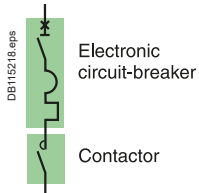

## Circuit breakers, and contactors

### Performance "Iq" (kA): U = 380-400V

Circuit breaker	B	F	N	H	S	L
GV4 P, PE & PEM 02 - 12	-	-	50	-	100 [4]	-
GV4 P, PE & PEM 25 - 115	25	-	50	-	100 [4]	-
NSX100/160/250 Micrologic 2.2M / 6.2M	-	36	50	70	100	130
NSX400/630 Micrologic 2.3M / 6.3M	-	36	50	70	100	130
NS800L/NS1000L Micrologic 5.0	-	-	-	-	-	130

### Starting [1] Standard IEC 60947-4-1

Trip unit normal (classe) long (classe)	GV4P, PE or PEM	Micrologic 2.2M / 2.3M 5. 10	Micrologic 6.2M / 6.3M 5. 10	Micrologic 5.0 10
10				
20		20	20. 30 [1]	20

Motors Rated power P(kW)	Guide values of operational current in amps at :			Circuit breakers			Contactors [2]	
	380V	400V	I <sub>e</sub> max	Type	trip unit	I <sub>rt</sub> (A)	I <sub>rm</sub> (A) [3]	Type
0.18	0.63	0.6	2	GV4P, PE or PEM	2	0.8/2	34	LC1-D25
0.25	0.89	0.85	2	GV4P, PE or PEM	2	0.8/2	34	LC1-D25
0.37	1.16	1.1	2	GV4P, PE or PEM	2	0.8/2	34	LC1-D25
0.55	1.58	1.5	2	GV4P, PE or PEM	2	0.8/2	34	LC1-D25
0.75	2.00	1.9	2	GV4P, PE or PEM	2	0.8/2	34	LC1-D25
1.1	2.8	2.7	3.5	GV4P, PE or PEM	3.5	1.4/3.5	60	LC1-D32
1.5	3.8	3.6	7	GV4P, PE or PEM	7	2.9/7	119	LC1-D50A
2.2	5.2	4.9	7	GV4P, PE or PEM	7	2.9/7	119	LC1-D50A
3	6.8	6.5	7	GV4P, PE or PEM	7	2.9/7	119	LC1-D50A
4	8.9	8.5	12.5	GV4P, PE or PEM	12.5	5/12.5	213	LC1-D50A
5.5	12.1	11.5	12.5	GV4P, PE or PEM	12.5	5/12.5	213	LC1-D50A
7.5	16.3	15.5	25	GV4P, PE or PEM	25	10/25	425	LC1-D65A
10	20	19	25	NSX100	Micrologic 2.2M or 6.2M	12/25	13I <sub>rt</sub>	LC1-D80
				GV4P, PE or PEM	25	10/25	425	LC1-D65A
11	23	22	25	NSX100	Micrologic 2.2M or 6.2M	12/25	13I <sub>rt</sub>	LC1-D80
				GV4P, PE or PEM	25	10/25	425	LC1-D65A
15	31	29	50	NSX100	Micrologic 2.2M or 6.2M	12/25	13I <sub>rt</sub>	LC1-D80
				GV4P, PE or PEM	50	20/50	850	LC1-D65A
18.5	37	35	50	NSX100	Micrologic 2.2M or 6.2M	25/50	13I <sub>rt</sub>	LC1-D80
				GV4P, PE or PEM	50	20/50	850	LC1-D65A
22	43	41	50	NSX100	Micrologic 2.2M or 6.2M	25/50	13I <sub>rt</sub>	LC1-D80
				GV4P, PE or PEM	50	20/50	850	LC1-D65A
30	58	55	65	NSX100	Micrologic 2.2M or 6.2M	25/50	13I <sub>rt</sub>	LC1-D80
				GV4P, PE or PEM	80	40/80	1360	LC1-D65A
37	69	66	80	NSX100	Micrologic 2.2M or 6.2M	50/100(80)	13I <sub>rt</sub>	LC1-D80
				GV4P, PE or PEM	80	40/80	1360	LC1-D80
45	84	80	115	NSX100	Micrologic 2.2M or 6.2M	50/100(80)	13I <sub>rt</sub>	LC1-D80
				GV4P, PE or PEM	115	65/115	1955	LC1-D115 or LC1-F115
55	102	97	115	NSX100	Micrologic 2.2M	50/100	13I <sub>rt</sub>	LC1-D115 or LC1-F115
				GV4P, PE or PEM	115	65/115	1955	LC1-D115 or LC1-F115
75	139	132	150	NSX160	Micrologic 2.2M or 6.2M	70/150	13I <sub>rt</sub>	LC1-D150 or LC1-F150
				NSX250	Micrologic 2.2M or 6.2M	100/220	13I <sub>rt</sub>	LC1-F225
90	168	160	185	NSX250	Micrologic 2.2M or 6.2M	100/220	13I <sub>rt</sub>	LC1-F225
				NSX400	Micrologic 2.3M or 6.3M	160/320	13I <sub>rt</sub>	LC1-F265
110	205	195	265	NSX400	Micrologic 2.3M or 6.3M	160/320	13I <sub>rt</sub>	LC1-F265
				NSX400	Micrologic 2.3M or 6.3M	160/320	13I <sub>rt</sub>	LC1-F330
132	242	230	265	NSX400	Micrologic 2.3M or 6.3M	160/320	13I <sub>rt</sub>	LC1-F330
				NSX630	Micrologic 2.3M or 6.3M	250/500	13I <sub>rt</sub>	LC1-F400 (70kA)
160	295	280	320	NSX630	Micrologic 2.3M or 6.3M	250/500	13I <sub>rt</sub>	LC1-F500 (130kA)
				NSX630	Micrologic 2.3M or 6.3M	250/500	13I <sub>rt</sub>	LC1-F500
200	368	350	400	NS800L	Micrologic 5.0	320/800	8000	LC1-F630
				NS800L	Micrologic 5.0	320/800	8000	LC1-F630
220	400	380	500	NS1000L	Micrologic 5.0	400/1000	10 000	LC1-F780 or LC1-F1000
				NS1000L	Micrologic 5.0	400/1000	10 000	LC1-F780 or LC1-F1000
250	453	430	500	NS1000L	Micrologic 5.0	400/1000	10 000	LC1-F780 or LC1-F1000
				NS1000L	Micrologic 5.0	400/1000	10 000	LC1-F780 or LC1-F1000
300	526	500	630	NS800L	Micrologic 5.0	320/800	8000	LC1-F630
				NS800L	Micrologic 5.0	320/800	8000	LC1-F630
315	568	540	630	NS800L	Micrologic 5.0	320/800	8000	LC1-F630
				NS800L	Micrologic 5.0	320/800	8000	LC1-F630
355	642	610	780/900	NS1000L	Micrologic 5.0	400/1000	10 000	LC1-F780 or LC1-F1000
				NS1000L	Micrologic 5.0	400/1000	10 000	LC1-F780 or LC1-F1000
400	726	690	780/900	NS1000L	Micrologic 5.0	400/1000	10 000	LC1-F780 or LC1-F1000
				NS1000L	Micrologic 5.0	400/1000	10 000	LC1-F780 or LC1-F1000
450	789	750	780/900	NS1000L	Micrologic 5.0	400/1000	10 000	LC1-F780 or LC1-F1000
				NS1000L	Micrologic 5.0	400/1000	10 000	LC1-F780 or LC1-F1000
500	895	850	900	NS1000L	Micrologic 5.0	400/1000	10 000	LC1-F1000
				NS1000L	Micrologic 5.0	400/1000	10 000	LC1-F1000

[1] For class 30 the contactor rating shall be checked according to 30s thermal withstand (F range).

[2] Reversers : replace LC1 with LC2 ; start-delta starter : replace LC1 with LC3.

[3] li for Micrologic 5.0 control unit.

[4] GV4PE and PEM only, for GV4 "S" performance with rotary handle, order GV4PE, PEM "S" & rotary handle separately.

# Type 2 coordination (IEC 60947-4-1)

Ue: 380-400 V AC

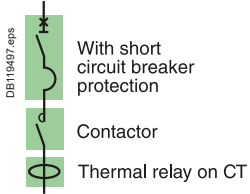

## Circuit breakers, contactors and thermal relays

### Performance "Iq" (kA): U = 380-400V

Circuit breaker	B	F	N	H	S	L
GV4L & LE 02 - 12	-	-	50	-	100 [4]	-
GV4L & LE 25 - 115	25	-	50	-	100 [4]	-
NSX100/160/250-MA	-	36	50	70	100	130
NSX400/630-MA	-	36	50	70	100	130
NS800L/NS1000L Micrologic 5.0	-	-	-	-	-	130

Starting [1]: adjustable class 10 A to 30.

Motors Rated power P(kW)	Guide values of operational current in amps at :			Circuit breakers		Contactors [2]	Thermal o/l relays Adj. class 10A to 30		
	380V	400V	le max	Type	rat(A)	Irm(A)	Type	Type	Irth [1]
0.18	0.63	0.6	2	GV4L or GV4LE	2	26	LC1-D32	LTM R08	0.4/8
0.25	0.89	0.85	2	GV4L or GV4LE	2	26	LC1-D32	LTM R08	0.4/8
0.37	1.16	1.1	2	GV4L or GV4LE	2	26	LC1-D32	LTM R08	0.4/8
0.55	1.58	1.5	2	GV4L or GV4LE	2	26	LC1-D32	LTM R08	0.4/8
0.75	2.00	1.9	2	GV4L or GV4LE	2	26	LC1-D32	LTM R08	0.4/8
1.1	2.8	2.7	3.5	GV4L or GV4LE	3.5	46	LC1-D40A	LTM R08	0.4/8
1.5	3.8	3.6	7	GV4L or GV4LE	7	91	LC1-D40A	LTM R08	0.4/8
2.2	5.2	4.9	7	GV4L or GV4LE	7	91	LC1-D40A	LTM R08	0.4/8
3	6.8	6.5	7	GV4L or GV4LE	7	91	LC1-D40A	LTM R08	0.4/8
4	8.9	8.5	10	GV4L or GV4LE	12.5	138	LC1-D65A	LTM R27	1.35/27
			12.5	NSX100-MA	12.5	163	LC1-D80	LTM R27	1.35/27
5.5	12.1	11.5	12.5	GV4L or GV4LE	12.5	163	LC1-D65A	LTM R27	1.35/27
				NSX100-MA	12.5	163	LC1-D80	LTM R27	1.35/27
7.5	16.3	15.5	25	GV4L or GV4LE	25	325	LC1-D65A	LTM R27	1.35/27
				NSX100-MA	25	325	LC1-D80	LTM R27	1.35/27
10	20	19	25	GV4L or GV4LE	25	325	LC1-D65A	LTM R27	1.35/27
				NSX100-MA	25	325	LC1-D80	LTM R27	1.35/27
11	23	22	25	GV4L or GV4LE	25	325	LC1-D65A	LTM R27	1.35/27
				NSX100-MA	25	325	LC1-D80	LTM R27	1.35/27
15	31	29	32	GV4L or GV4LE	50	550	LC1-D65A	LTM R100	5/100
			32	NSX100-MA	50	550	LC1-D80	LTM R100	5/100
18.5	37	35	40	GV4L or GV4LE	50	550	LC1-D65A	LTM R100	5/100
			50	NSX100-MA	50	550	LC1-D80	LTM R100	5/100
22	43	41	50	GV4L or GV4LE	50	650	LC1-D65A	LTM R100	5/100
				NSX100-MA	50	550	LC1-D80	LTM R100	5/100
30	58	55	65	GV4L or GV4LE	80	880	LC1-D65A	LTM R100	5/100
			80	NSX100-MA	100	1100	LC1-D80	LTM R100	5/100
37	69	66	80	GV4L or GV4LE	80	1040	LC1-D80	LTM R100	5/100
				NSX100-MA	100	1100	LC1-D80	LTM R100	5/100
45	84	80	92	GV4L or GV4LE	115	1265	LC1-D115 or F115	LTM R100	5/100
			100	NSX160-MA	150	1300	LC1-D115 or F115	LTM R100	5/100
55	102	97	110	GV4L or GV4LE	115	1495	LC1-D115 or F115	LTM R08	on CT
			115	NSX160-MA	150	1300	LC1-D115 or F115	LTM R08	on CT
75	139	132	150	NSX160-MA	150	1950	LC1-D150 or F150	LTM R08	on CT
90	168	160	185	NSX250-MA	220	2420	LC1-F185	LTM R08	on CT
110	205	195	220	NSX250-MA	220	2860	LC1-F225	LTM R08	on CT
			265	NSX400 1.3M	320	3500	LC1-F265	LTM R08	on CT
132	242	230	265	NSX400 1.3M	320	3500	LC1-F265	LTM R08	on CT
160	295	280	320	NSX400 1.3M	320	4000	LC1-F330	LTM R08	on CT
200	368	350	400	NSX630-1.3M	500	5500	LC1-F400 (70kA)	LTM R08	on CT
			500	NSX630-1.3M	500	5500	LC1-F500 (130kA)	LTM R08	on CT
220	400	380	500	NSX630-1.3M	500	6500	LC1-F500	LTM R08	on CT
250	453	430	500	NSX630-1.3M	500	6500	LC1-F500	LTM R08	on CT
300	526	500	630	NS800L - Micrologic 5.0 - LR off	800	8000	LC1-F630	LTM R08	on CT
315	568	540	630	NS800L - Micrologic 5.0 - LR off	800	8000	LC1-F630	LTM R08	on CT
355	642	610	630	NS800L - Micrologic 5.0 - LR off	800	8000	LC1-F630	LTM R08	on CT
400	726	690	780	NS1000L - Micrologic 5.0 - LR off	1000	10000	LC1-F780	LTM R08	on CT
							or LC1F1000		
450	789	750	780	NS1000L - Micrologic 5.0 - LR off	1000	10000	LC1-F780	LTM R08	on CT
							or LC1F1000		
500	895	850	780	NS1000L - Micrologic 5.0 - LR off	1000	10000	LC1-F780	LTM R08	on CT
							or LC1F1000		
500		850	900.00	NS1000L - Micrologic 5.0 - LR off	1000	10000	LC1-F1000	LTM R08	on CT

[1] For installations with a class 30 relay, a derating of 20% must be apply on Circuit breakers and the contacteur rating shall be checked according to 30s thermal withstand (F range).

[2] Reversers : replace LC1 with LC2 ; start-delta starter : replace LC1 with LC3.

[3] li for Micrologic 5.0 control unit.

[4] GV4LE only, for GV4 "S" performance with rotary handle, order GV4LE "S" & rotary handle separately.

# Type 2 coordination (IEC 60947-4-1)

Ue: 415 V AC

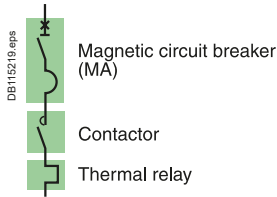

## Circuit breakers, contactors and thermal relays

### Performance "Iq" (kA): U = 415V

Circuit breaker	B	F	N	H	S	L
GV4L & LE 02 - 12	-	-	50	-	100 [4]	-
GV4L & LE 25 - 115	25	-	50	-	100 [4]	-
NSX100/160/250-MA	-	36	50	70	100	130
NSX400/630-Micrologic 1.3M	-	36	50	70	100	130
NS800L/NS1000L Micrologic 5.0	-	-	-	-	-	130

Starting [1]: normal LRD class 10 A, LR9 class 10.



Motors Rated power P(kW)	Guide values of operational current in amps at :		Circuit breakers			Contactors [2]		Thermal o/l relays	
	415V	le max	Type	rat(A)	Irm(A) [3]	Type	Type	Irth [1]	
0.18	0.58	1	GV4L	2	14	LC1-D09	LRD-05	0.63/1	
0.25	0.82	1	GV4L	2	14	LC1-D09	LRD-05	0.63/1	
0.37	1.06	1.6	GV4L	2	22	LC1-D09	LRD-06	1/1.6	
0.55	1.45	2	GV4L	2	26	LC1-D09	LRD-06	1.6/2.5	
0.75	1.83	2	GV4L	2	26	LC1-D09	LRD-07	1.6/2.5	
1.1	2.60	3.5	GV4L	3.5	46	LC1-D25	LRD-08	2.5/4	
1.5	3.5	4	GV4L or GV4LE	7	56	LC1-D32 + GV1L3	LRD-08	2.5/4	
2.2	4.7	6	GV4L or GV4LE	7	84	LC1-D32 + GV1L3	LRD-10	4/6	
3	6.3	7	GV4L	7	91	LC1-D40A	LRD-12 [5]	5.5/8	
4	8.2	10	GV4L	12.5	138	LC1-D65A	LRD-14 [5]	7 / 10	
5.5	11.1	12.5	GV4L	12.5	163	LC1-D65A	LRD-313	9/13	
7.5	14.9	18	GV4L	25	250	LC1-D65A	LRD-318	12/18	
10	18.3	25	NSX100-MA	25	250	LC1-D80	LRD 3321	12/18	
			GV4L	25	325	LC1-D65A	LRD-325	17/25	
11	21.2	25	NSX100-MA	25	325	LC1-D80	LRD 3322	17/25	
			GV4L	25	325	LC1-D65A	LRD-325	17/25	
15	28.0	32	NSX100-MA	25	325	LC1-D80	LRD 3322	17/25	
			GV4L	50	450	LC1-D65A	LRD-332	23/32	
18.5	33.7	40	NSX100-MA	50	450	LC1-D80	LRD-33 53	23/32	
			GV4L	50	550	LC1-D65A	LRD-340	30/40	
22	39.5	50	NSX100-MA	50	550	LC1-D80	LRD-33 55	30/40	
			GV4L	50	650	LC1-D65A	LRD-350	37/50	
30	53.0	63	NSX100-MA	50	550	LC1-D80	LRD-33 55	30/40	
			GV4L	80	880	LC1-D65A	LRD-365	48/65	
37	63.6	80	NSX100-MA	100	1100	LC1-D80	LRD-33 59	48/65	
			GV4L	80	1040	LC1-D80	LRD-33 63	63/80	
45	77.1	80	NSX100-MA	100	1100	LC1-D80	LRD-33 63	63/80	
			GV4L	80	1040	LC1-D80	LRD-33 63	63/80	
55	93.5	115	NSX100-MA	100	1100	LC1-D80	LRD-33 63	63/80	
			GV4L	115	1495	LC1-D115	LR9D-5369	90/150	
75	127.2	150	NSX160-MA	150	1950	LC1-F115	LR9-F5369	90/150	
			NSX160-MA	150	1950	LC1-D150	LR9-D53 69	90/150	
90	154.2	185	NSX250-MA	220	2420	LC1-F150	LR9-F53 69	90/150	
110	188.0	220	NSX250-MA	220	2860	LC1-F150	LR9-F53 69	90/150	
132	221.7	265	NSX400-Micrologic 1.3M	320	3500	LC1-F150	LR9-F53 69	90/150	
160	269.9	320	NSX400-Micrologic 1.3M	320	4160	LC1-F330	LR9-F73 75	200/330	
200	337.3	400	NSX630-Micrologic 1.3M	500	5500	LC1-F400 (70kA)	LR9-F73 79	300/500	
220	366.3	400	NSX630-Micrologic 1.3M	500	5500	LC1-F500 (130kA)	LR9-F73 79	300/500	
			NSX630-Micrologic 1.3M	500	6500	LC1-F400 (70kA)	LR9-F73 79	300/500	
250	414.5	500	NSX630-Micrologic 1.3M	500	6500	LC1-F500 (130kA)	LR9-F73 79	300/500	
			NSX630-Micrologic 1.3M	500	6500	LC1-F500	LR9-F73 79	300/500	
300	481.9	630	NS800L - Micrologic 5.0 - LR off	800	8000	LC1-F630	LR9-F73 81	380/630	
315	520.5	630	NS800L - Micrologic 5.0 - LR off	800	8000	LC1-F630	LR9-F73 81	380/630	
355	588.0	630	NS800L - Micrologic 5.0 - LR off	800	8000	LC1-F630	LR9-F73 81	380/630	
400	665.1	780	NS1000L - Micrologic 5.0 - LR off	1000	9600	LC1-F780/ LC1F1000	TC800/1 + LRD-05	500/800	
450	722.9	780	NS1000L - Micrologic 5.0 - LR off	1000	10000	LC1-F780/ LC1F1000	TC800/1 + LRD-05	500/800	
500	819.3	850	NS1000L - Micrologic 5.0 - LR off	1000	10000	LC1-F1000	TC1000/1 + LRD-05	500/1000	

[1] Heavy starting (class 20), see thermal O/L chart of equivalence.  
 [2] Reversers : replace LC1 with LC2 ; start-delta starter : replace LC1 with LC3.  
 [3] li for Micrologic 5.0 control unit.  
 [4] GV4LE only, for GV4 "S" performance with rotary handle, order GV4LE "S" & rotary handle separately.  
 [5] Separate overload Relay, use terminal block LAD7B106.

# Type 2 coordination (IEC 60947-4-1)

Ue: 415 V AC

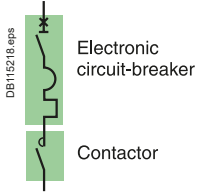

## Circuit breakers, contactors

Performance "Iq" (kA): Ue = 415 V

Circuit breaker	B	F	N	H	S	L
GV4 P, PE & PEM 02 - 12	-	-	50	-	100 <sup>[4]</sup>	-
GV4 P, PE & PEM 25 - 115	25	-	50	-	100 <sup>[4]</sup>	-
NSX100/160/250 Micrologic 2.2M / 6.2M	-	36	50	70	100	130
NSX400/630 Micrologic 2.3M / 6.3M	-	36	50	70	100	130
NS800L/NS1000L Micrologic 5.0	-	-	-	-	-	130

### Starting<sup>[1]</sup> Standard IEC 60947-4-1

Trip unit normal (classe)	GV4P, PE or PEM	Micrologic 2.2M / 2.3M	Micrologic 6.2M / 6.3M	Micrologic 5.0
long (classe)	20	20	20. 30 <sup>[1]</sup>	20

Motors Rated power P(kW)	Guide values of operational current in amps at : 415V		Circuit breakers				Contactors <sup>[2]</sup>
	le max		Type	trip unit	I <sub>rt</sub> (A)	I <sub>rm</sub> (A) <sup>[3]</sup>	Type
0.18	0.58	2	GV4P, PE or PEM	2	0.8/2	34	LC1-D25
0.25	0.82	2	GV4P, PE or PEM	2	0.8/2	34	LC1-D25
0.37	1.06	2	GV4P, PE or PEM	2	0.8/2	34	LC1-D25
0.55	1.45	2	GV4P, PE or PEM	2	0.8/2	34	LC1-D25
0.75	1.83	2	GV4P, PE or PEM	2	0.8/2	34	LC1-D25
1.1	2.60	3.5	GV4P, PE or PEM	3.5	1.4/3.5	60	LC1-D32
1.5	3.5	7	GV4P, PE or PEM	7	2.9/7	119	LC1-D50A
2.2	4.7	7	GV4P, PE or PEM	7	2.9/7	119	LC1-D50A
3	6.3	7	GV4P, PE or PEM	7	2.9/7	119	LC1-D50A
4	8.2	12.5	GV4P, PE or PEM	12.5	5/12.5	213	LC1-D50A
5.5	11.1	12.5	GV4P, PE or PEM	12.5	5/12.5	213	LC1-D50A
7.5	15	25	GV4P, PE or PEM	25	10/25	425	LC1-D65A
10	18	25	NSX100	Micrologic 2.2M or 6.2M	12/25	13I <sub>rth</sub>	LC1-D80
			GV4P, PE or PEM	25	10/25	425	LC1-D65A
11	21	25	NSX100	Micrologic 2.2M or 6.2M	12/25	13I <sub>rth</sub>	LC1-D80
			GV4P, PE or PEM	25	10/25	425	LC1-D65A
15	28	50	NSX100	Micrologic 2.2M or 6.2M	12/25	13I <sub>rth</sub>	LC1-D80
			GV4P, PE or PEM	50	10/25	850	LC1-D65A
18.5	34	50	NSX100	Micrologic 2.2M or 6.2M	25/50	13I <sub>rth</sub>	LC1-D80
			GV4P, PE or PEM	50	20/50	850	LC1-D65A
22	40	50	NSX100	Micrologic 2.2M or 6.2M	25/50	13I <sub>rth</sub>	LC1-D80
			GV4P, PE or PEM	50	20/50	850	LC1-D65A
30	53	65	NSX100	Micrologic 2.2M or 6.2M	25/50	13I <sub>rth</sub>	LC1-D80
			GV4P, PE or PEM	80	40/80	1360	LC1-D65A
37	64	80	NSX100	Micrologic 2.2M or 6.2M	50/100(80)	13I <sub>rth</sub>	LC1-D80
			GV4P, PE or PEM	80	40/80	1360	LC1-D80
45	77	115	NSX100	Micrologic 2.2M	50/100	13I <sub>rth</sub>	LC1-D115 or LC1-F115
			GV4P, PE or PEM	115	65/115	1955	LC1-D115 or LC1-F115
55	94	115	NSX160	Micrologic 2.2M or 6.2M	70/150	13I <sub>rth</sub>	LC1-D150 or LC1-F150
			GV4P, PE or PEM	115	65/115	1955	LC1-D115 or LC1-F115
75	127	150	NSX160	Micrologic 2.2M or 6.2M	70/150	13I <sub>rth</sub>	LC1-D150 or LC1-F150
			NSX250	Micrologic 2.2M or 6.2M	100/220	13I <sub>rth</sub>	LC1-F225
90	154	185	NSX250	Micrologic 2.2M or 6.2M	100/220	13I <sub>rth</sub>	LC1-F225
110	188	220	NSX400	Micrologic 2.3M or 6.3M	160/320	13I <sub>rth</sub>	LC1-F265
132	222	265	NSX400	Micrologic 2.3M or 6.3M	160/320	13I <sub>rth</sub>	LC1-F330
160	270	320	NSX630	Micrologic 2.3M or 6.3M	250/500	13I <sub>rth</sub>	LC1-F400 (70kA)
200	337	400	NSX630	Micrologic 2.3M or 6.3M	250/500	13I <sub>rth</sub>	LC1-F500 (130kA)
220	366	400	NSX630	Micrologic 2.3M or 6.3M	250/500	13I <sub>rth</sub>	LC1-F400 (70kA)
			NSX630	Micrologic 2.3M or 6.3M	250/500	13I <sub>rth</sub>	LC1-F500 (130kA)
250	415	500	NSX630	Micrologic 2.3M or 6.3M	250/500	13I <sub>rth</sub>	LC1-F500
300	482	630	NS800L	Micrologic 5.0	320/800	8000	LC1-F630
315	521	630	NS800L	Micrologic 5.0	320/800	8000	LC1-F630
355	588	780	NS1000L	Micrologic 5.0	400/1000	10000	LC1-F780 or LC1F1000
400	665	780	NS1000L	Micrologic 5.0	400/1000	10000	LC1-F780 or LC1F1000
450	723	780	NS1000L	Micrologic 5.0	400/1000	10000	LC1-F780 or LC1F1000
500	819	850	NS1000L	Micrologic 5.0	400/1000	10000	LC1F1000

[1] For class 30 the contactor rating shall be checked according to 30s thermal withstand (F range).

[2] Reversers : replace LC1 with LC2 ; start-delta starter : replace LC1 with LC3.

[3] li for Micrologic 5.0 control unit.

[4] GV4PE and PEM only, for GV4 "S" performance with rotary handle, order GV4PE, PEM "S" & rotary handle separately



# Type 2 coordination (IEC 60947-4-1)

Ue: 415 V AC

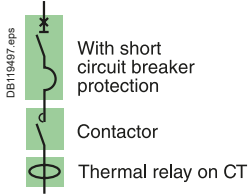

## Circuit breakers, contactors and thermal relays

### Performance "Iq" (kA): Ue = 415 V

Circuit breakers	B	F	N	H	S	L
GV4 L & LE 02 - 12	-	-	50	-	100 [4]	-
GV4 L & LE 25 - 115	25	-	50	-	100 [4]	-
NSX100/160/250-MA	-	36	50	70	100	130
NSX400/630-MA	-	36	50	70	100	130
NS800L/NS1000L Micrologic 5.0	-	-	-	-	-	130

Starting [1]: adjustable class 10 A to 30.



Motors Rated power P(kW)	Guide values of operational current in amps at :		Circuit breakers			Contactors [2]		Thermal o/l relays	
	415V	Ie max	Type	rat(A)	Irm(A)	Type	Adj. class 10A to 30		
0.18	0.58	2	GV4L	2	26	LC1-D32	LTM R08	0.4/8	
0.25	0.82	2	GV4L	2	26	LC1-D32	LTM R08	0.4/8	
0.37	1.06	2	GV4L	2	26	LC1-D32	LTM R08	0.4/8	
0.55	1.45	2	GV4L	2	26	LC1-D32	LTM R08	0.4/8	
0.75	1.83	2	GV4L	2	26	LC1-D32	LTM R08	0.4/8	
1.1	2.60	3.5	GV4L	3.5	46	LC1-D40A	LTM R08	0.4/8	
1.5	3.5	7	GV4L	7	91	LC1-D40A	LTM R08	0.4/8	
2.2	4.7	7	GV4L	7	91	LC1-D40A	LTM R08	0.4/8	
3	6.3	7	GV4L	7	91	LC1-D40A	LTM R08	0.4/8	
4	8.2	10	GV4L	12.5	138	LC1-D65A	LTM R27	1.35/27	
5.5	11.1	12.5	NSX100-MA	12.5	163	LC1-D80	LTM R27	1.35/27	
			GV4L	12.5	163	LC1-D65A	LTM R27	1.35/27	
7.5	14.9	25	NSX100-MA	12.5	163	LC1-D80	LTM R27	1.35/27	
			GV4L	25	325	LC1-D65A	LTM R27	1.35/27	
10	18.3	25	NSX100-MA	25	325	LC1-D80	LTM R27	1.35/27	
			GV4L	25	325	LC1-D65A	LTM R27	1.35/27	
11	21.2	25	NSX100-MA	25	325	LC1-D80	LTM R27	1.35/27	
			GV4L	25	325	LC1-D65A	LTM R27	1.35/27	
15	28.0	32	NSX100-MA	25	325	LC1-D80	LTM R27	1.35/27	
			GV4L	50	550	LC1-D65A	LTM R100	5/100	
18.5	33.7	40	NSX100-MA	50	650	LC1-D80	LTM R100	5/100	
			GV4L	50	550	LC1-D65A	LTM R100	5/100	
22	39.5	50	NSX100-MA	50	650	LC1-D80	LTM R100	5/100	
			GV4L	50	650	LC1-D65A	LTM R100	5/100	
30	53.0	65	NSX100-MA	50	650	LC1-D80	LTM R100	5/100	
			GV4L	80	880	LC1-D65A	LTM R100	5/100	
37	63.6	80	NSX100-MA	100	1100	LC1-D80	LTM R100	5/100	
			GV4L	80	1040	LC1-D80	LTM R100	5/100	
45	77.1	115	NSX100-MA	100	1100	LC1-D80	LTM R100	5/100	
			GV4L	115	1265	LC1-D115	LTM R100	5/100	
55	93.5	115	NSX100-MA	100	1100	LC1-D115	LTM R100	5/100	
			GV4L	115	1495	LC1-D115	LTM R08	sur TC/on CT	
75	127.2	150	NSX160-MA	150	1950	LC1-D150 or LC1F50	LTM R08	sur TC/on CT	
			NSX160-MA	150	1950	LC1-D150 or LC1F50	LTM R08	sur TC/on CT	
90	154.2	185	NSX250-MA	220	2420	LC1-F185	LTM R08	sur TC/on CT	
110	188.0	220	NSX250-MA	220	2860	LC1-F225	LTM R08	sur TC/on CT	
132	221.7	265	NSX400 1.3M	320	3500	LC1-F265	LTM R08	sur TC/on CT	
160	269.9	320	NSX400 1.3M	320	4000	LC1-F330	LTM R08	sur TC/on CT	
200	337.3	400	NSX630-1.3M	500	5500	LC1-F400 (70kA)	LTM R08	sur TC/on CT	
			NSX630-1.3M	500	6300	LC1-F500 (130kA)	LTM R08	sur TC/on CT	
220	366.3	400	NSX630-1.3M	500	5500	LC1-F400 (70kA)	LTM R08	sur TC/on CT	
			NSX630-1.3M	500	6300	LC1-F500 (130kA)	LTM R08	sur TC/on CT	
250	414.5	500	NSX630-1.3M	500	6300	LC1-F500	LTM R08	sur TC/on CT	
300	481.9	630	NS800L - Micrologic 5.0 - LR off	800	8000	LC1-F630	LTM R08	sur TC/on CT	
315	520.5	630	NS800L - Micrologic 5.0 - LR off	800	8000	LC1-F630	LTM R08	sur TC/on CT	
355	588.0	780	NS1000L - Micrologic 5.0 - LR off	1000	10000	LC1-F780 or LC1F1000	LTM R08	sur TC/on CT	
400	665.1	780	NS1000L - Micrologic 5.0 - LR off	1000	10000	LC1-F780 or LC1F1000	LTM R08	sur TC/on CT	
450	722.9	780	NS1000L - Micrologic 5.0 - LR off	1000	10000	LC1-F780 or LC1F1000	LTM R08	sur TC/on CT	
500	819.3	900	NS1000L - Micrologic 5.0 - LR off	1000	10000	LC1F1000	LTM R08	sur TC/on CT	

[1] For installations with a class 30 relay, a derating of 20% must be apply on Circuit breakers and the contacteur rating shall be checked according to 30s thermal withstand (F range).

[2] Reversers : replace LC1 with LC2 ; start-delta starter : replace LC1 with LC3.

[3] ii for Micrologic 5.0 control unit.

[4] GV4LE only, for GV4 "S" performance with rotary handle, order GV4LE "S" & rotary handle separately

# Type 2 coordination (IEC 60947-4-1)

Ue: 440 V AC

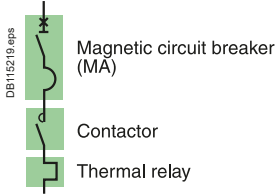

## Circuit breakers, contactors and thermal relays

Performance "Iq" (kA): Ue = 440V [2]

Circuit breakers	B	F	N	H	S	L
GV4L & LE 02 - 12	-	-	50	-	70 [4]	-
GV4L & LE 25 - 115	20	-	50	-	70 [4]	-
NSX100/160/250-MA	-	35	50	65	90	130
NSX400/630-Micrologic 1.3M	-	30	42	65	90	130
NS630bL/NS800L/NS1000L Micrologic 5.0	-	-	-	-	-	130

Starting [1]: normal LRD class 10 A, LR9 class 10.

Motors Rated power P(kW)	Guide values of operational current in amps at : 440V (A)		Circuit breakers			Contactors [2]		Thermal o/l relays	
	le	le max	Type	rat(A)	Irm(A) [6]	Type	Type	Irth [1]	
0.18	0.55	1	GV4L or GV4LE	2	14	LC1-D09	LRD-05	0.63/1	
0.25	0.77	1	GV4L or GV4LE	2	14	LC1-D09	LRD-05	0.63/1	
0.37	1	1.6	GV4L or GV4LE	2	22	LC1-D09	LRD-06	1/1.6	
0.55	1.36	1.6	GV4L or GV4LE	2	22	LC1-D09	LRD-06	1/1.6	
0.75	1.7	2	GV4L or GV4LE	2	26	LC1-D09	LRD-07	1.6/2.5	
1.1	2.4	2.5	GV4L or GV4LE	3.5	35	LC1-D25 + GV1L3	LR9D07	1.6/2.5	
1.5	3.3	3.5	GV4L or GV4LE	3.5	46	LC1-D32 + GV1L3	LR9D08	2.5/4	
2.2	4.5	5	GV4L or GV4LE	7	70	LC1-D32 + GV1L3	LR9D10	4/6	
3	5.9	7	GV4L or GV4LE	7	91	LC1-D40A	LRD-12 [5]	5.5/8	
4	7.7	8	GV4L or GV4LE	12.5	113	LC1-D65A	LRD-12 [5]	5.5/8	
5.5	10.5	12.5	GV4L or GV4LE	12.5	163	LC1-D65A	LRD-313	9/13	
7.5	14	16	GV4L or GV4LE	25	225	LC1-D65A	LRD-318	12/18	
10	18.2	18	NSX100-MA	25	250	LC1-D80	LRD 3321	12/18	
		25	GV4L or GV4LE	25	325	LC1-D65A	LRD-325	17/25	
11	20	25	NSX100-MA	25	325	LC1-D80	LRD 3322	17/25	
		25	GV4L or GV4LE	25	325	LC1-D65A	LRD-325	17/25	
15	26	32	NSX100-MA	25	325	LC1-D80	LRD 3322	17/25	
		32	GV4L or GV4LE	50	450	LC1-D65A	LRD-332	23/32	
18.5	32	40	NSX100-MA	50	450	LC1-D80	LRD-3353	23/32	
		40	GV4L or GV4LE	50	550	LC1-D65A	LRD-340	30/40	
22	38	40	NSX100-MA	50	550	LC1-D80	LRD-3355	30/40	
		40	GV4L or GV4LE	50	550	LC1-D65A	LRD-340	30/40	
30	50	65	NSX100-MA	50	550	LC1-D80	LRD-3355	30/40	
		63	GV4L or GV4LE	80	880	LC1-D65A	LRD-365	48/65	
37	60	65	NSX100-MA	100	900	LC1-D80	LRD-3359	48/65	
		63	GV4L or GV4LE	80	880	LC1-D65A	LRD-365	48/65	
45	73	80	NSX100-MA	100	900	LC1-D80	LRD-3359	48/65	
		80	GV4L or GV4LE	80	1040	LC1-D80	LRD-33 63	63/80	
55	88	100	NSX100-MA	100	1100	LC1-D80	LRD-3363	63/80	
		100	GV4L or GV4LE	115	1380	LC1-D115	LR9-D5367	60/100	
75	120	150	NSX100-MA	100	1300	LC1-F115	LR9-F5367		
		150	NSX160-MA	150	1950	LC1-D115	LR9-D5367	60/100	
90	145	150	NSX160-MA	150	1950	LC1-F115	LR9-F5367		
		150	NSX160-MA	150	1950	LC1-D150	LR9-D5369	90/150	
110	177	185	NSX160-MA	150	1950	LC1-F150	LR9-F5369	90/150	
		185	NSX250-MA	220	2420	LC1-F150	LR9-F5369		
132	209	265	NSX400-Micrologic 1.3M	320	3500	LC1-F185	LR9-F5371	132/220	
160	255	265	NSX400-Micrologic 1.3M	320	3500	LC1-F265	LR9-F5371	132/220	
200	318	320	NSX400-Micrologic 1.3M	320	4160	LC1-F265	LR9-F7375	200/330	
220	343	400	NSX400-Micrologic 1.3M	320	4160	LC1-F330	LR9-F7375	200/330	
		400	NSX630-Micrologic 1.3M	500	5500	LC1-F400 (70kA)	LR9-F7379	300/500	
250	390	500	NSX630-Micrologic 1.3M	500	6500	LC1-F500 (130kA)	LR9-F7379	300/500	
		500	NSX630-Micrologic 1.3M	500	6500	LC1-F500	LR9-F7379	300/500	
300	466	500	NS800L - Micrologic 5.0 - LR off	800	8000	LC1-F630	LR9-F7379	300/500	
315	490	630	NS800L - Micrologic 5.0 - LR off	800	8000	LC1-F630	LR9-F7381	380/630	
355	554	630	NS800L - Micrologic 5.0 - LR off	800	8000	LC1-F630	LR9-F7381	380/630	
375	587	630	NS800L - Micrologic 5.0 - LR off	800	8000	LC1-F630	LR9-F7381	380/630	
400	627	720	NS800L - Micrologic 5.0 - LR off	800	9600	LC1-F780	TC800/1 + LRD-05	500/800	
450	695	720	NS800L - Micrologic 5.0 - LR off	800	9600	or LC1F1000			
		720	NS800L - Micrologic 5.0 - LR off	800	9600	LC1-F780	TC800/1 + LRD-05	500/800	
500	772	780	NS1000L - Micrologic 5.0 - LR off	1000	10000	or LC1F1000			
		780	NS1000L - Micrologic 5.0 - LR off	1000	10000	LC1F1000	TC800/1 + LRD-05	500/800	
560	863	900	NS1000L - Micrologic 5.0 - LR off	1000	10000	LC1F1000	TC1000/1 + LRD-05	600/1000	

[1] For long starting (class 20), see the correspondence table for thermal relay.

[2] For 480V Consult us.

[3] Reversers : replace LC1 with LC2 ; start-delta starter : replace LC1 with LC3.

[4] GV4LE only, for GV4 "S" performance with rotary handle, order GV4LE "S" & rotary handle separately.

[5] separate overload Relay, use terminal block LAD7B106.

[6] li for Micrologic 5.0 control unit.

# Type 2 coordination (IEC 60947-4-1)

Ue: 440 V AC

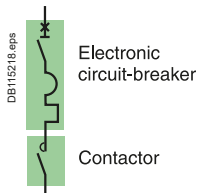

## Circuit breakers, and contactors

Performance "Iq" (kA): Ue = 440V [2]

Circuit breaker	B	F	N	H	S	L
GV4 P, PE & PEM 02 - 12	-	-	50	-	70 [5]	-
GV4 P, PE & PEM 25 - 115	20	-	50	-	70 [5]	-
NSX100/160/250-MA	-	35	42	65	90	130
NSX400/630-MA	-	30	42	65	90	130
NS630bL/NS800L/NS1000L Micrologic 5.0	-	-	-	-	-	130

### Starting [1] Standard IEC 60947-4-1

Trip unit normal (classe)	GV4P, PE or PEM	Micrologic 2.2M / 2.3M	Micrologic 6.2M / 6.3M	Micrologic 5.0
long (classe)	10	5. 10	5. 10	10
	20	20	20. 30 [1]	20

Motors Rated power P(kW)	Guide values of operational current in amps at : 440V (A)		Circuit breakers				Contactors [2]
	Ie max (A)		Type	trip unit	I <sub>rt</sub> (A)	I <sub>rm</sub> (A) [4]	Type
0.18	0.55	2	GV4P, PE or PEM	2	0.8/2	34	LC1-D25
0.25	0.77	2	GV4P, PE or PEM	2	0.8/2	34	LC1-D25
0.37	1	2	GV4P, PE or PEM	2	0.8/2	34	LC1-D25
0.55	1.36	2	GV4P, PE or PEM	2	0.8/2	34	LC1-D25
0.75	1.7	2	GV4P, PE or PEM	2	0.8/2	34	LC1-D25
1.1	2.4	2.5	GV4P, PE or PEM	3.5	1.4/3.5	60	LC1-D32
1.5	3.3	3.5	GV4P, PE or PEM	3.5	1.4/3.5	60	LC1-D32
2.2	4.5	7	GV4P, PE or PEM	7	2.9/7	119	LC1-D65A
3	5.9	7	GV4P, PE or PEM	7	2.9/7	119	LC1-D65A
4	7.7	12.5	GV4P, PE or PEM	12.5	5/12.5	213	LC1-D65A
5.5	10.5	12.5	GV4P, PE or PEM	12.5	5/12.5	213	LC1-D65A
7.5	14	25	GV4P, PE or PEM	25	10/25	425	LC1-D65A
		20	NSX100	Micrologic 2.2M / 6.2M	12/20	13I <sub>rt</sub>	LC1-D80
10	18.2	25	GV4P, PE or PEM	25	10/25	425	LC1-D65A
		25	NSX100	Micrologic 2.2M / 6.2M	15/25	13I <sub>rt</sub>	LC1-D80
11	20	25	GV4P, PE or PEM	25	10/25	425	LC1-D65A
		50	NSX100	Micrologic 2.2M / 6.2M	15/25	13I <sub>rt</sub>	LC1-D80
15	26	50	GV4P, PE or PEM	50	20/50	850	LC1-D65A
		40	NSX100	Micrologic 2.2M / 6.2M	24/40	13I <sub>rt</sub>	LC1-D80
18.5	32	50	GV4P, PE or PEM	50	20/50	850	LC1-D65A
		40	NSX100	Micrologic 2.2M / 6.2M	24/40	13I <sub>rt</sub>	LC1-D80
22	38	50	GV4P, PE or PEM	50	20/50	850	LC1-D65A
		40	NSX100	Micrologic 2.2M / 6.2M	24/40	13I <sub>rt</sub>	LC1-D80
30	50	63	GV4P, PE or PEM	80	40/80	1360	LC1-D65A
		80	NSX100	Micrologic 2.2M / 6.2M	48/80	13I <sub>rt</sub>	LC1-D80
37	60	63	GV4P, PE or PEM	80	40/80	1360	LC1-D65A
		80	NSX100	Micrologic 2.2M / 6.2M	48/80	13I <sub>rt</sub>	LC1-D80
45	73	80	GV4P, PE or PEM	80	40/80	1360	LC1-D80
		100	NSX100	Micrologic 2.2M / 6.2M	48/80	13I <sub>rt</sub>	LC1-D80
55	88	100	GV4P, PE or PEM	115	65/115	1955	LC1-D115 or LC1-F115
		150	NSX100	Micrologic 2.2M / 6.2M	60/100	13I <sub>rt</sub>	LC1-D115 or LC1-F115
75	120	150	NSX160	Micrologic 2.2M / 6.2M	90/150	13I <sub>rt</sub>	LC1-D150 or LC1-F150
90	145	150	NSX160	Micrologic 2.2M / 6.2M	90/150	13I <sub>rt</sub>	LC1-D150 or LC1-F150
110	177	185	NSX250	Micrologic 2.2M / 6.2M	131/220	13I <sub>rt</sub>	LC1-F225
132	209	265	NSX400	Micrologic 2.3M / 6.3M	160/320	13I <sub>rt</sub>	LC1-F265
160	255	265	NSX400	Micrologic 2.3M / 6.3M	160/320	13I <sub>rt</sub>	LC1-F265
200	318	320	NSX400	Micrologic 2.3M / 6.3M	160/320	13I <sub>rt</sub>	LC1-F330
220	343	400	NSX630	Micrologic 2.3M / 6.3M	250/500	13I <sub>rt</sub>	LC1-F400 (70kA)
		500					LC1-F500 (130kA)
250	390	400	NSX630	Micrologic 2.3M / 6.3M	250/500	13I <sub>rt</sub>	LC1-F500
300	466	500	NSX630	Micrologic 2.3M / 6.3M	250/500	13I <sub>rt</sub>	LC1-F500
315	490	630	NS800L	Micrologic 5.0	320/800	8000	LC1-F630
355	554	630	NS800L	Micrologic 5.0	320/800	8000	LC1-F630
375	587	630	NS800L	Micrologic 5.0	320/800	8000	LC1-F630
400	627	720	NS800L	Micrologic 5.0	320/800	9600	LC1-F780 or LC1F1000
450	695	720	NS800L	Micrologic 5.0	320/800	9600	LC1-F780 or LC1F1000
500	772	800	NS1000L	Micrologic 5.0	400/1000	10000	LC1-F1000
560	863	900	NS1000L	Micrologic 5.0	400/1000	10000	LC1-F1000

[1] For class 30 the contacteur rating shall be checked according to 30s thermal withstand (F range).

[2] For 480V Consult us.

[3] Reversers : replace LC1 with LC2 ; start-delta starter : replace LC1 with LC3.

[4] li for Micrologic 5.0 control unit.

[5] GV4PE only, for GV4 "S" performance with rotary handle, order GV4PE "S" & rotary handle separately.

# Type 2 coordination (IEC 60947-4-1)

U<sub>e</sub>: 440 V AC

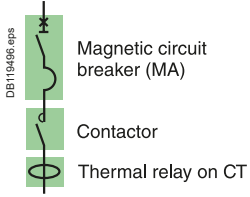

## Circuit breakers, contactors and thermal relays

Performance "I<sub>q</sub>" (kA): U<sub>e</sub> = 440V [1]

Circuit breakers	B	F	N	H	S	L
GV4 L & LE 02 - 12	-	-	50	-	70 [4]	-
GV4 L & LE 25 - 115	20	-	50	-	70 [4]	-
NSX400/630-Micrologic 1.3M	-	30	42	65	90	130
NS630bL/NS800L/NS1000L Micrologic 5.0	-	-	-	-	-	130

Starting [1]: normal LRD class 10 A, LR9 class 10.

Motors Rated power P(kW)	Guide values of operational current in amps at :		Circuit breakers			Contactors [2]		Thermal o/l relays Adj. class 10A to 30	
	440V (A)	I <sub>e</sub> max	Type	rat(A)	I <sub>rm</sub> (A) [4]	Type	Type	I <sub>rth</sub> [1]	
0.18	0.55	2	GV4L or GV4LE	2	26	LC1-D32	LTM R08	0.4/8	
0.25	0.77	2	GV4L or GV4LE	2	26	LC1-D32	LTM R08	0.4/8	
0.37	1	2	GV4L or GV4LE	2	26	LC1-D32	LTM R08	0.4/8	
0.55	1.36	2	GV4L or GV4LE	2	26	LC1-D32	LTM R08	0.4/8	
0.75	1.7	2	GV4L or GV4LE	2	26	LC1-D32	LTM R08	0.4/8	
1.1	2.4	3.5	GV4L or GV4LE	3.5	46	LC1-D40A	LTM R08	0.4/8	
1.5	3.3	3.5	GV4L or GV4LE	3.5	46	LC1-D40A	LTM R08	0.4/8	
2.2	4.5	7	GV4L or GV4LE	7	91	LC1-D40A	LTM R08	0.4/8	
3	5.9	7	GV4L or GV4LE	7	91	LC1-D40A	LTM R08	0.4/8	
4	7.7	10	GV4L or GV4LE	12.5	138	LC1-D65A	LTM R27	1.35/27	
		12.5	NSX100-MA	12.5	163	LC1-D80	LTM R27	1.35/27	
5.5	10.5	12.5	GV4L or GV4LE	12.5	163	LC1-D65A	LTM R27	1.35/27	
			NSX100-MA	12.5	163	LC1-D80	LTM R27	1.35/27	
7.5	14	25	GV4L or GV4LE	25	325	LC1-D65A	LTM R27	1.35/27	
			NSX100-MA	25	325	LC1-D80	LTM R27	1.35/27	
10	18.2	25	GV4L or GV4LE	25	325	LC1-D65A	LTM R27	1.35/27	
			NSX100-MA	25	325	LC1-D80	LTM R27	1.35/27	
11	20	25	GV4L or GV4LE	25	325	LC1-D65A	LTM R27	1.35/27	
			NSX100-MA	25	325	LC1-D80	LTM R27	1.35/27	
15	26	32	GV4L or GV4LE	50	550	LC1-D65A	LTM R100	5/100	
		32	NSX100-MA	50	550	LC1-D80	LTM R100	5/100	
18.5	32	40	GV4L or GV4LE	50	550	LC1-D65A	LTM R100	5/100	
		50	NSX100-MA	50	550	LC1-D80	LTM R100	5/100	
22	38	50	GV4L or GV4LE	50	650	LC1-D65A	LTM R100	5/100	
			NSX100-MA	50	550	LC1-D80	LTM R100	5/100	
30	50	65	GV4L or GV4LE	80	880	LC1-D65A	LTM R100	5/100	
		80	NSX100-MA	100	1100	LC1-D80	LTM R100	5/100	
37	60	65	GV4L or GV4LE	80	880	LC1-D65A	LTM R100	5/100	
		80	NSX100-MA	100	1100	LC1-D80	LTM R100	5/100	
45	73	80	GV4L or GV4LE	80	1040	LC1-D80	LTM R100	5/100	
			NSX100-MA	100	1100	LC1-D80	LTM R100	5/100	
55	88	100	GV4L or GV4LE	115	1380	LC1-D115	LTM R100	5/100	
						LC1-F115	LTM R100	5/100	
75	120	150	NSX100-MA	100	1300	LC1-D115 or F115	LTM R100	5/100	
90	145	150	NSX160-MA	150	1950	LC1-D150 or F150	LTM R08	on CT	
110	177	185	NSX250-MA	220	2420	LC1-F185	LTM R08	on CT	
132	209	265	NSX400-Micrologic 1.3M	320	3500	LC1-F265			
160	255	265	NSX400-Micrologic 1.3M	320	3500	LC1-F265	LTM R08	on CT	
200	318	320	NSX400-Micrologic 1.3M	320	4000	LC1-F330	LTM R08	on CT	
220	343	400	NSX630-Micrologic 1.3M	500	5500	LC1-F400 (70kA)	LTM R08	on CT	
		500	NSX630-Micrologic 1.3M	500	6500	LC1-F500 (130kA)	LTM R08	on CT	
250	390	500	NSX630-Micrologic 1.3M	500	6500	LC1-F500	LTM R08	on CT	
300	466	500	NSX630-Micrologic 1.3M	500	6500	LC1-F500	LTM R08	on CT	
315	490	630	NS800L - Micrologic 5.0 - LR off	800	8000	LC1-F630	LTM R08	on CT	
355	554	630	NS800L - Micrologic 5.0 - LR off	800	8000	LC1-F630	LTM R08	on CT	
375	587	630	NS800L - Micrologic 5.0 - LR off	800	8000	LC1-F630	LTM R08	on CT	
400	627	720	NS800L - Micrologic 5.0 - LR off	800	9600	LC1-F780 or LC1-F1000	LTM R08	on CT	
450	695	720	NS800L - Micrologic 5.0 - LR off	800	9600	LC1-F780 or LC1-F1000	LTM R08	on CT	
500	772	800	NS1000L - Micrologic 5.0 - LR off	1000	10000	LC1-F1000	LTM R08	on CT	
560	863	900	NS1000L - Micrologic 5.0 - LR off	1000	10000	LC1-F1000	LTM R08	on CT	

[1] For 480V Consult us.

[2] For installations with a class 30 relay, a derating of 20% must be apply on Circuit breakers and the contacteur rating shall be checked according to 30s thermal withstand (F range).

[3] Reversers : replace LC1 with LC2 ; start-delta starter : replace LC1 with LC3.

[4] GV4LE only, for GV4 "S" performance with rotary handle, order GV4LE "S" & rotary handle separately.

# Type 2 coordination (IEC 60947-4-1)

U<sub>e</sub>: 690 V AC

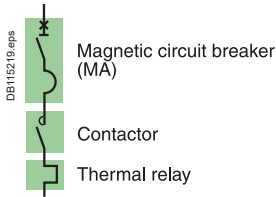

## Circuit breakers, contactors and thermal relays

Performance "I<sub>q</sub>" (kA) : U<sub>e</sub> = 690 V

Circuit breaker	I <sub>q</sub>
GV2 < L06 or GV2 ≥ L07 + LA9 LB920	50 kA
GV2 < P06 or GV2 ≥ P07 + LA9 LB920	50 kA

Starting [1]: normal LRD class 10 A.

GV2L								
Motors			Circuit breaker			Contactors [3]		Thermal o/l relays
P (kW)	I (A) 690 V	I <sub>e</sub> max	Type	Rating (A)	I <sub>rm</sub> (A)	Type	Type	I <sub>rth</sub> [1]
0.37	0.64	0.64	GV2-L04	0.63	8	LC1-D09	LRD05	0.63...1
0.55	0.87	1	GV2-L05	1	13	LC1-D09	LRD05	0.63...1
0.75	1.1	1.6	GV2-L06	1.6	21	LC1-D09	LRD06	1...1.6
1.1	1.6	2.5	LA9LB920 [2] + GV2-L07	2.5	33	LC1-D25	LRD07	1.6...2.5
1.5	2.1	2.5	LA9LB920 [2] + GV2-L07	2.5	33	LC1-D25	LRD07	1.6...2.5
2.2	2.8	4	LA9LB920 [2] + GV2-L08	4	52	LC1-D25	LRD08	2.5...4
3	3.8	4	LA9LB920 [2] + GV2-L08	4	52	LC1-D25	LRD08	2.5...4
4	4.9	6	LA9LB920 [2] + GV2-L10	6.3	82	LC1-D25	LRD10	4...6
5.5	6.7	8	LA9LB920 [2] + GV2-L14	10	130	LC1-D25	LRD12	5.5...8
7.5	8.9	10	LA9LB920 [2] + GV2-L14	10	130	LC1-D25	LRD14	7...10
10	11.5	13	LA9LB920 [2] + GV2-L16	14	182	LC1-D25	LRD16	9...13
15	17	18	LA9LB920 [2] + GV2-L20	18	234	LC1-D32	LRD21	12...18
18.5	21	21	LA9LB920 [2] + GV2-L22	25	325	LC1-D40A	LRD325	16...24
22	24	32	LA9LB920 [2] + GV2-L32	32	416	LC1-D40A	LRD332	23...32

GV2P						
Motors			Circuit breaker		Contactors [3]	
P (kW)	I (A) 690 V	I <sub>e</sub> max	Type	I <sub>rth</sub> (A)	I <sub>rm</sub> (A)	Type
0.37	0.63	0.63	GV2-P04	0.63		LC1-D09
0.55	0.87	1	GV2-P05	1		LC1-D09
0.75	1.1	1.6	GV2-P06	1.6		LC1-D09
1.1	1.6	2.5	LA9LB920 [2] + GV2-P07	2.5		LC1-D25
1.5	2.1	2.5	LA9LB920 [2] + GV2-P07	2.5		LC1-D25
2.2	2.8	4	LA9LB920 [2] + GV2-P08	4		LC1-D25
3	3.8	4	LA9LB920 [2] + GV2-P08	4		LC1-D25
4	4.9	6.3	LA9LB920 [2] + GV2-P10	6.3		LC1-D25
5.5	6.7	10	LA9LB920 [2] + GV2-P14	10		LC1-D25
7.5	8.9	10	LA9LB920 [2] + GV2-P14	10		LC1-D25
10	12	14	LA9LB920 [2] + GV2-P16	14		LC1-D25
11	12.8	14	LA9LB920 [2] + GV2-P16	14		LC1-D32
15	17	18	LA9LB920 [2] + GV2-P20	18		LC1-D32
18.5	21	23	LA9LB920 [2] + GV2-P21	23		LC1-D32
22	24	32	LA9LB920 [2] + GV2-P32	32		LC1-D40A

Starting: adjustable								
Motors			Circuit breaker			Contactors [3]		Thermal o/l relays
P (kW)	I (A) 690 V	I <sub>e</sub> max	Type	Rating (A)	I <sub>rm</sub> (A)	Type	Type	I <sub>rth</sub> [1]
0.37	0.64	0.64	GV2-L04	0.63	8	LC1-D09	LTM R08	0.4/8
0.55	0.87	1	GV2-L05	1	13	LC1-D09	LTM R08	0.4/8
0.75	1.1	1.6	GV2-L06	1.6	21	LC1-D09	LTM R08	0.4/8
1.1	1.6	2.5	LA9LB920 [2] + GV2-L07	2.5	33	LC1-D25	LTM R08	0.4/8
1.5	2.1	2.5	LA9LB920 [2] + GV2-L07	2.5	33	LC1-D25	LTM R08	0.4/8
2.2	2.8	4	LA9LB920 [2] + GV2-L08	4	52	LC1-D25	LTM R08	0.4/8
3	3.8	4	LA9LB920 [2] + GV2-L08	4	52	LC1-D25	LTM R08	0.4/8
4	4.9	6	LA9LB920 [2] + GV2-L10	6.3	82	LC1-D25	LTM R08	0.4/8
5.5	6.7	8	LA9LB920 [2] + GV2-L14	10	130	LC1-D25	LTM R08	0.4/8
7.5	8.9	10	LA9LB920 [2] + GV2-L14	10	130	LC1-D25	LTM R27	1.35/27
11	12.8	14	LA9LB920 [2] + GV2-L16	14	182	LC1-D25	LTM R27	1.35/27
15	17	18	LA9LB920 [2] + GV2-L20	18	234	LC1-D32	LTM R27	1.35/27
18.5	21	21	LA9LB920 [2] + GV2-L22	25	325	LC1-D40A	LTM R27	1.35/27
22	24	27	LA9LB920 [2] + GV2-L32	32	416	LC1-D40A	LTM R27	1.35/27

[1] For long starting (class 20), see the correspondence table for thermal relay.  
 [2] One LA9LB920 limiter (on the supply side of the breaker) can be used for several starter up to 32 A.  
 Connections between limiter and GV2 breaker shall be done in such a way to minimize the risk of short circuit.  
 [3] Reversers : replace LC1 with LC2 ; start-delta starter : replace LC1 with LC3.

## Type 2 coordination (IEC 60947-4-1)

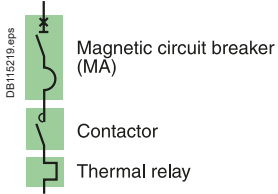
U<sub>e</sub>: 690 V AC

## Circuit breakers, contactors and thermal relays

Performance "I<sub>q</sub>" (kA) : U<sub>e</sub> = 690 V

Circuit breaker	I <sub>q</sub>
LUALB1	70 kA
LA9LB920	35 kA

Starting : adjustable.

Motors P (kW)	I (A)	I <sub>e</sub> max	TeSys U		Limiter	Control unit	
			Type <sup>[2]</sup>	I <sub>m</sub>		Type <sup>[1]</sup>	I <sub>rth</sub>
0.37	0.64	0.64	LUB12	14.2 In	LUALB1	LUC●01	0.35...1.4
			LUB12	14.2 In	LA9LB920	LUC●01	0.35...1.4
0.55	0.87	1	LUB12	14.2 In	LUALB1	LUC●01	0.35...1.4
			LUB12	14.2 In	LA9LB920	LUC●01	0.35...1.4
0.75	1.1	1.6	LUB12	14.2 In	LUALB1	LUC●01	0.35...1.4
			LUB12	14.2 In	LA9LB920	LUC●01	0.35...1.4
1.1	1.6	2.5	LUB12	14.2 In	LUALB1	LUC●05	1.25...5
			LUB12	14.2 In	LA9LB920	LUC●05	1.25...5
1.5	2.1	2.5	LUB12	14.2 In	LUALB1	LUC●05	1.25...5
			LUB12	14.2 In	LA9LB920	LUC●05	1.25...5
2.2	2.8	4	LUB12	14.2 In	LUALB1	LUC●05	1.25...5
			LUB12	14.2 In	LA9LB920	LUC●05	1.25...5
3	3.8	4	LUB12	14.2 In	LUALB1	LUC●05	1.25...5
			LUB12	14.2 In	LA9LB920	LUC●05	1.25...5
4	4.9	6	LUB12	14.2 In	LUALB1	LUC●12	3...12
			LUB12	14.2 In	LA9LB920	LUC●12	3...12
5.5	6.7	8	LUB12	14.2 In	LUALB1	LUC●12	3...12
			LUB12	14.2 In	LA9LB920	LUC●12	3...12
7.5	8.9	10	LUB12	14.2 In	LUALB1	LUC●12	3...12
			LUB12	14.2 In	LA9LB920	LUC●12	3...12
11	12.8	18	LUB32	14.2 In	LUALB1	LUC●18	4.5...18
			LUB32	14.2 In	LA9LB920	LUC●18	4.5...18
15	17	18	LUB32	14.2 In	LUALB1	LUC●18	4.5...18
			LUB32	14.2 In	LA9LB920	LUC●18	4.5...18
18.5	21	25	LUB32	14.2 In	LUALB1	LUC●32	8...32
			LUB32	14.2 In	LA9LB920	LUC●32	8...32

[1] to be replaced by A, B, D or CM according to protection and monitoring needs.

[2] For Reversing replace LUB12 by LU2B12 and LUB32 by LU2B32.

# Type 2 coordination (IEC 60947-4-1)

Ue: 690 V AC

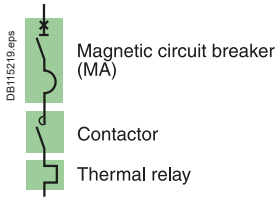

## Circuit breakers, contactors and thermal relays

Performance "Iq" (kA) : Ue = 690 V

Circuit breakers	HB1	HB2	LB
NSX100/250 MA	75 kA	100 kA	-
NSX400/630 Micrologic 1.3M	75 kA	100 kA	-
NS800 Micrologic 5.0x	-	-	75 kA

Starting <sup>[1]</sup>: normal LRD class 10 A, LR9 class 10.

Motors Rated power P(kW)	Guide values of operational current in amps at :		Circuit breakers			Contactors <sup>[2]</sup>		Thermal o/l relays <sup>[1]</sup>	
	690V (A)	Ie max	Type	rat(A)	Irm(A) <sup>[3]</sup>	Type	Type	Irth	
0.37	0.64	1	NSX100-MA	12.5	75	LC1-D80	CT 1A + LRD05	0.63..1	
0.55	0.87	1	NSX100-MA	12.5	75	LC1-D80	CT 1A + LRD05	0.63..1	
0.75	1.1	1.5	NSX100-MA	12.5	75	LC1-D80	CT 1.5A + LRD05	0.95..1.5	
1.1	1.6	2.5	NSX100-MA	12.5	75	LC1-D80	CT 2A + LRD05	1.26..2	
1.5	2.1	2.5	NSX100-MA	12.5	75	LC1-D80	CT 2.5A + LRD05	1.6..2.5	
2.2	2.8	4	NSX100-MA	12.5	75	LC1-D80	CT 4A + LRD05	2.5..4	
3	3.8	4	NSX100-MA	12.5	75	LC1-D80	CT 4A + LRD05	2.5..4	
4	4.9	6	NSX100-MA	12.5	112	LC1-D80	CT 6A + LRD05	3.8..6	
5.5	6.7	7.5	NSX100-MA	12.5	112	LC1-D80	CT 7.5A + LRD05	4.7..7.5	
7.5	8.9	12.5	NSX100-MA	12.5	162	LC1-D80	CT 10A + LRD05	6.3..10	
10	11.5	12.5	NSX100-MA	12.5	162	LC1-D80	CT 12.5A + LRD05	7.8..12.5	
11	12.8	20	NSX100-MA	25	162	LC1-D80	CT 20A + LRD05	12.6..20	
15	17	20	NSX100-MA	25	300	LC1-D80	CT 20A + LRD05	12.6..20	
18.5	21	25	NSX100-MA	25	325	LC1-D80	CT 24A + LRD05	15.24	
22	24	25	NSX100-MA	25	325	LC1-D80	CT 30A + LRD05	19..30	
30	32	40	NSX100-MA	50	550	LC1-D150	CT 40A + LRD05	25..40	
37	39	50	NSX100-MA	50	650	LC1-D150	CT 50A + LRD05	31.5..50	
45	47	50	NSX100-MA	50	650	LC1-D150	CT 50A + LRD05	31.5..50	
55	57	63	NSX100-MA	100	900	LC1-D150	LR9-F53 63 or CT 50A + LRD05	48..80	
						LC1-F115	LR9-F53 63 or CT 50A + LRD05	48..80	
75	77	80	NSX100-MA	100	1100	LC1-D150	LR9-F53 63 or CT 100A + LRD05	48..80	
						LC1-F115	LR9-F53 63 or CT 100A + LRD05	48..80	
90	93	100	NSX250-MA	150	1350	LC1-F150	LR9-F53 67 or CT 100A + LRD05	60..100	
110	113	115	NSX250-MA	150	1500	LC1-F185	LR9-F53 69 or CT 125A + LRD 05	90..150	
132	134	150	NSX250-MA	150	1950	LC1-F330	LR9-F53 71 or CT 160A + LRD05	132..220	
160	162	220	NSX250-MA	220	2860	LC1-F330	LR9-F53 71 or CT 200A + LRD05	132..220	
200	203	220	NSX250-MA	220	2860	LC1-F330	LR9-F53 71 or CT 250A + LRD05	132..220	
220	220	225	NSX400-Micrologic 1.3M	320	3200	LC1-F400 45kA	LR9-F73 75 or CT 320A + LRD05	200..330	
						LC1-F500 100kA	LR9-F73 75 or CT 320A + LRD05	200..330	
250	250	280	NSX400-Micrologic 1.3M	320	3840	LC1-F400 45kA	LR9-F73 75 or CT 320A + LRD05	200..330	
						LC1-F500 100kA	LR9-F73 75 or CT 320A + LRD05	200..330	
315	313	330	NSX630-Micrologic 1.3M	500	4500	LC1-F500	LR9-F73 75 or CT 320A + LRD05	200..330	
335	335	340	NSX630-Micrologic 1.3M	500	4500	LC1-F500	LR9-F73 79 or CT 400A+LRD05	300..500	
355	354	460	NSX630-Micrologic 1.3M	500	6000	LC1-F630	LR9-F73 79 or CT 400A+LRD05	300..500	
375	374	460	NSX630-Micrologic 1.3M	500	6000	LC1-F630	LR9-F73 79 or CT 400A+LRD05	300..500	
400	400	460	NSX630-Micrologic 1.3M	500	6000	LC1-F630	LR9-F73 81 or CT 500A+LRD05	380..630	
450	455	460	NSX630-Micrologic 1.3M	500	6000	LC1-F630	LR9-F73 81 or CT 500A+LRD05	380..630	
475	475	480	NS800LB - Micrologic 5.0 LR Off	800	6400	LC1-F780	LR9-F73 81 or CT 500A+LRD05	380..630	

[1] CT: Current transformer for motor thermal relay, for instance S11 range from RS ISOLSEC.

[2] Reversers : replace LC1 with LC2 ; start-delta starter : replace LC1 with LC3.

[3] li for Micrologic 5.0 control unit.

## Type 2 coordination (IEC 60947-4-1)

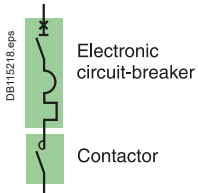
U<sub>e</sub>: 690 V AC

## Circuit breakers, contactors

Performance "I<sub>q</sub>" (kA) : U<sub>e</sub> = 690 V

Circuit breakers	HB1	HB2	LB
NSX100/160/250 Micrologic 2.2 M/6.2 M	75 kA	100 kA	-
NSX400/630 Micrologic 2.2 M/6.2 M	75 kA	100 kA	-
NS800 Micrologic 5.0x	-	-	75 kA

Starting	Standard IEC 60947-4-1		
Micrologic	2.2 M/2.3 M	6.2 M/6.3 M	5.0
Normal (class)	5. 10	5. 10	10
Long (class)	20	20. 30	20

Motors			Circuit breakers				Contactors <sup>[1]</sup>
P (kW)	I (A) 690 V	I <sub>e</sub> max	Type	Trip unit	I <sub>rth</sub> (A)	I <sub>rm</sub> (A) <sup>[2]</sup>	Type
10	11.6	25	NSX100	Micrologic 2.2 M or 6.2 M	12/25	13 I <sub>rth</sub>	LC1 D80
11	12.8	25	NSX100	Micrologic 2.2 M or 6.2 M	12/25	13 I <sub>rth</sub>	LC1 D80
15	17	25	NSX100	Micrologic 2.2 M or 6.2 M	12/25	13 I <sub>rth</sub>	LC1 D80
18.5	22	25	NSX100	Micrologic 2.2 M or 6.2 M	12/25	13 I <sub>rth</sub>	LC1 D80
22	24	25	NSX100	Micrologic 2.2 M or 6.2 M	12/25	13 I <sub>rth</sub>	LC1 D80
30	32	50	NSX100	Micrologic 2.2 M or 6.2 M	25/50	13 I <sub>rth</sub>	LC1 D150 / F115
37	39	50	NSX100	Micrologic 2.2 M or 6.2 M	25/50	13 I <sub>rth</sub>	LC1 D150 / F115
45	47	50	NSX100	Micrologic 2.2 M or 6.2 M	25/50	13 I <sub>rth</sub>	LC1 D150 / F115
55	57	63	NSX100	Micrologic 2.2 M or 6.2 M	50/100	13 I <sub>rth</sub>	LC1 D150 / F115
75	77	80	NSX100	Micrologic 2.2 M or 6.2 M	50/100	13 I <sub>rth</sub>	LC1 D150 / F115
90	93	100	NSX250	Micrologic 2.2 M or 6.2 M	70/150	13 I <sub>rth</sub>	LC1 F150
110	113	125	NSX250	Micrologic 2.2 M or 6.2 M	70/150	13 I <sub>rth</sub>	LC1 F185
132	134	150	NSX250	Micrologic 2.2 M or 6.2 M	70/150	13 I <sub>rth</sub>	LC1 F330
160	162	220	NSX250	Micrologic 2.2 M or 6.2 M	100/220	13 I <sub>rth</sub>	LC1 F330
200	203	220	NSX250	Micrologic 2.3 M or 6.3 M	100/220	13 I <sub>rth</sub>	LC1 F330
220	223	280	NSX400	Micrologic 2.3 M or 6.3 M	160/320	13 I <sub>rth</sub>	LC1 F400 (45 kA) LC1 F500 (100 kA)
250	250	280	NSX400	Micrologic 2.3 M or 6.3 M	160/320	13 I <sub>rth</sub>	LC1 F400 (45 kA) LC1 F500 (100 kA)
315	313	340	NSX630	Micrologic 2.3 M or 6.3 M	250/500	13 I <sub>rth</sub>	LC1 F500
335	335	340	NSX630	Micrologic 2.3 M or 6.3 M	250/500	13 I <sub>rth</sub>	LC1 F500
355	354	460	NSX630	Micrologic 2.3 M or 6.3 M	250/500	13 I <sub>rth</sub>	LC1 F630
375	374	460	NSX630	Micrologic 2.3 M or 6.3 M	250/500	13 I <sub>rth</sub>	LC1 F630
400	400	460	NSX630	Micrologic 2.3 M or 6.3 M	250/500	13 I <sub>rth</sub>	LC1 F630
450	455	460	NSX630	Micrologic 2.3 M or 6.3 M	250/500	13 I <sub>rth</sub>	LC1 F630
475	475	480	NS800LB	Micrologic 5.0	320/800	13 I <sub>rth</sub>	LC1 F780

[1] Reversers: replace LC1 with LC2; start-delta starter: replace LC1 with LC3.

[2] I<sub>i</sub> for Micrologic 5.0 control unit.



# Type 2 coordination (IEC 60947-4-1)

U<sub>e</sub>: 690 V AC

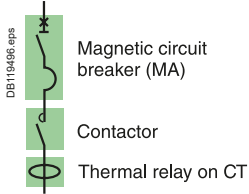

## Circuit breakers, contactors

Performance "I <sub>q</sub> " (kA): U <sub>e</sub> = 690 V			
Circuit breakers	HB1	HB2	LB
NSX100/250 MA	75 kA	100 kA	-
NSX400/630 Micrologic 1.3 M	75 kA	100 kA	-
NS800 Micrologic 5.0x	-	-	75 kA

Starting: adjustable.

Motors P (kW)	I (A) 690 V	I <sub>e</sub> max	Circuit breakers Type	Rating (A)	I <sub>rm</sub> (A)	Contactors <sup>[2]</sup> Type	Thermal o/l relays Type	I <sub>rth</sub> <sup>[1]</sup>
0.37	0.64	8	NSX100-MA	12.5	75	LC1-D80	LTM R08	0.4/8
0.55	0.87	8	NSX100-MA	12.5	75	LC1-D80	LTM R08	0.4/8
0.75	1.1	8	NSX100-MA	12.5	75	LC1-D80	LTM R08	0.4/8
1.1	1.6	8	NSX100-MA	12.5	75	LC1-D80	LTM R08	0.4/8
1.5	2.1	8	NSX100-MA	12.5	75	LC1-D80	LTM R08	0.4/8
2.2	2.8	8	NSX100-MA	12.5	75	LC1-D80	LTM R08	0.4/8
3	3.8	8	NSX100-MA	12.5	75	LC1-D80	LTM R08	0.4/8
4	4.9	8	NSX100-MA	12.5	112	LC1-D80	LTM R08	0.4/8
5.5	6.7	8	NSX100-MA	12.5	112	LC1-D80	LTM R08	0.4/8
7.5	8.9	12.5	NSX100-MA	12.5	162	LC1-D80	LTM R27	1.35/27
11	12.8	25	NSX100-MA	25	325	LC1-D80	LTM R27	1.35/27
15	17	25	NSX100-MA	25	325	LC1-D80	LTM R27	1.35/27
18.5	21	25	NSX100-MA	25	325	LC1-D80	LTM R27	1.35/27
22	24	25	NSX100-MA	25	400	LC1-D80	LTM R27	1.35/27
30	32	50	NSX100-MA	50	650	LC1-D150/F115	LTM R100	5/100
37	39	50	NSX100-MA	50	650	LC1-D150/F115	LTM R100	5/100
45	47	50	NSX100-MA	50	650	LC1-D150/F115	LTM R100	5/100
55	57	63	NSX100-MA	100	1100	LC1-D150/F115	LTM R100	5/100
75	77	80	NSX100-MA	100	1100	LC1-D150/F115	LTM R100	5/100
90	93	100	NSX250-MA	150	1350	LC1-F150	LTM R100	5/100
110	113	115	NSX250-MA	150	1500	LC1-F185	LTM R08	on TC
132	134	150	NSX250-MA	150	1950	LC1-F330	LTM R08	on TC
160	162	220	NSX250-MA	220	2420	LC1-F330	LTM R08	on TC
200	203	220	NSX250-MA	220	2420	LC1-F330	LTM R08	on TC
220	223	225	NSX400-Micrologic 1.3M	320	3200	LC1-F400 45 kA	LTM R08	on TC
250	250	280	NSX400-Micrologic 1.3M	320	3840	LC1-F500 100 kA	LTM R08	on TC
						LC1-F400 45 kA		
						LC1-F500 100 kA		
315	313	340	NSX630-Micrologic 1.3M	500	4500	LC1-F500	LTM R08	on TC
335	335	340	NSX630-Micrologic 1.3M	500	4500	LC1-F500	LTM R08	on TC
355	354	460	NSX630-Micrologic 1.3M	500	6000	LC1-F630	LTM R08	on TC
375	374	460	NSX630-Micrologic 1.3M	500	6000	LC1-F630	LTM R08	on TC
400	400	460	NSX630-Micrologic 1.3M	500	6000	LC1-F630	LTM R08	on TC
450	455	460	NSX630-Micrologic 1.3M	500	6000	LC1-F630	LTM R08	on TC
475	475	480	NS800LB Micrologic 5 LR Off		6400	LC1-F780	LTM R08	on TC

[1] Check contactor and circuit breaker thermal withstand for installations with a class 30 relay.

[2] Reversers: replace LC1 with LC2; start-delta starter: replace LC1 with LC3.

# Type 1 coordination (IEC 60947-4-1)

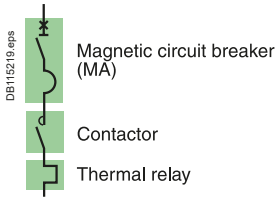

## GV4L circuit breaker, contactor and Overload relay

### Direct-on-line starting

### Reverser

"Iq" breaking performance: equal to the breaking capacity of the circuit breaker alone.

Starting<sup>[1]</sup>: Direct on line normal start Class 10A/10.

B

Motors												Circuit breakers		Contactors <sup>[3]</sup>		Thermal relays <sup>[1]</sup>	
220/230 V		380 V		415 V		440 V		500-525 V		660-690 V		Type	cal (A)	Type	Type	Irth (A)	
P (kW)	I (A)	P (kW)	I (A)	P (kW)	I (A)	P (kW)	I (A)	P (kW)	I (A)	P (kW)	I (A)						
0.37	1.8	0.37	1.2	0.37	1.1	0.37	1	0.55	1.2	0.75	1.2	GV4L or LE	2	LC1-D09	LRD 06	1/1.6	
		0.55	1.6	0.55	1.5	0.55	1.4	0.75	1.5	1	1.5	GV4L or LE	2	LC1-D09	LRD 06	1/1.6	
		0.75	2	0.75	1.8	0.75	1.7	1.1	2	1.5	2	GV4L or LE	2	LC1-D09	LRD 07	1.6/2.5	
0.55	2.8	1.1	2.8	1.1	2.6			1.5	2.6	2.2	2.8	GV4L or LE	3.5	LC1-D09	LRD 08	2.5/4	
		1.5	3.8	1.5	3.5	1.5	3.3			3	3.8	GV4L or LE	7	LC1-D09	LRD 08	2.5/4	
1.1	4.4	2.2	5.2	2.2	4.7	2.2	4.5	3	5	4	4.9	GV4L or LE	7	LC1-D09	LRD 10	4/6	
1.5	6.1	3	6.6	3	6.5	3	5.8	4	6.5	5.5	6.6	GV4L or LE	7	LC1-D09	LRD 12	5.5/8	
2.2	8.7	4	8.5	4	8.2	4	7.9	5.5	9	7.5	8.9	GV4L or LE	12.5	LC1-D09	LRD 14	7/10	
												GV4L or LE	12.5	LC1-D12	LRD 14	7/10	
3	11.5	5.5	11.5	5.5	11.1	5.5	10.5	7.5	12	10	11.5	GV4L or LE	12.5	LC1-D12	LRD 16	9/13	
												GV4L or LE	25	LC1-D18	LRD 21	12/18	
4	14.5	7.5	16	7.5	15	7.5	14	9	14	10	15	GV4L or LE	25	LC1-D18	LRD 21	12/18	
												GV4L or LE	25	LC1-D18	LRD 16	9/13	
5.5	20	11	23	11	21	11	20	11	18.4	15	17	GV4L or LE	25	LC1-D25	LRD 22	16/24	
												GV4L or LE	25	LC1-D25	LRD 21	12/18	
7.5	28	15	30	15	28	15	26.5	18.5	28.5	18.5	21.3	GV4L or LE	25	LC1-D32	LRD 22	16/24	
												GV4L or LE	50	LC1-D32	LRD 32	23/32	
11	39	18.5	37	18.5	35	22	37			30	34.6	GV4L or LE	50	LC1-D40A	LRD 340	30/40	
		22	44	22	40			30	45	33	39	GV4L or LE	50	LC1-D40A	LRD 350	37/50	
15	52					30	50			37	42	GV4L or LE	50	LC1-D50A	LRD 350	37/50	
												GV4L or LE	50	LC1-D65A	LRD 365	48/65	
18.5	64	30	58	30	53	37	60	37	55			GV4L or LE	80	LC1-D65A	LRD 350	37/50	
				37	64							45	47	GV4L or LE	80	LC1-D65A	LRD 365
22	75	37	69	45	77	45	73	55	80	55	57	GV4L or LE	80	LC1-D80	LRD 3561	55/70	
												45	80				
										55	57	GV4L or LE	115	LC1-D80	LRD 3363	63/80	
												GV4L or LE	115	LC1-D95	LRD 3365	80/104	
30	95	55	97	55	93	55	90	75	106	90	93	GV4L or LE	80	LC1-D115	LRD 3561	55/70	
												GV4L or LE	80	LC1-D115	LR9D5367	60/100	
												GV4L or LE	115	LC1-D115	LR9D5369	90/150	

[1] For long starting (class 20), see the correspondence table for thermal relay.

[2] For 480V application consult us.

[3] Reversers : replace LC1 with LC2.

# Type 1 coordination (IEC 60947-4-1)

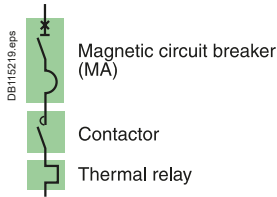

## NSX100 circuit breakers, contactors and thermal relays

### Direct-on-line starting

#### Reverser

"Iq" breaking performance: equal to the breaking capacity of the circuit breaker alone.

Starting <sup>[1]</sup>: normal class 10A/10.



Motors												Circuit breakers		Contactors <sup>[3]</sup>	Thermal relays <sup>[1]</sup>	
220/230 V		380 V		415 V		440 V <sup>[2]</sup>		500-525 V		660-690 V		Type	cal (A)	Type	Type	lrth (A)
P (kW)	I (A)	P (kW)	I (A)	P (kW)	I (A)	P (kW)	I (A)	P (kW)	I (A)	P (kW)	I (A)	Type	cal (A)	Type	Type	lrth (A)
0.37	1.8	0.37	1.2	0.37	1.1	0.37	1	0.55	1.2	0.75	1.2	NSX100B/F/N/H/S/L MA	2.5	LC1-D09	LRD 06	1/1.6
		0.55	1.6	0.55	1.5	0.55	1.4	0.75	1.5	1	1.5	NSX100B/F/N/H/S/L MA	2.5	LC1-D09	LRD 06	1/1.6
0.55	2.8	0.75	2	0.75	1.8	0.75	1.7					NSX100B/F/N/H/S/L MA	2.5	LC1-D09	LRD 07	1.6/2.5
						1.1	2.4	1.1	2	1.5	2	NSX100B/F/N/H/S/L MA	2.5	LC1-D09	LRD 07	1.6/2.5
1.1	4.4	1.1	2.8	1.1	2.5			1.5	2.6	2.2	2.8	NSX100B/F/N/H/S/L MA	6.3	LC1-D09	LRD 08	2.5/4
		1.5	3.7	1.5	3.5	1.5	3.1			3	3.8	NSX100B/F/N/H/S/L MA	6.3	LC1-D09	LRD 08	2.5/4
1.5	6.1	2.2	5	2.2	4.8	2.2	4.5	3	5	4	4.9	NSX100B/F/N/H/S/L MA	6.3	LC1-D09	LRD 10	4/6
		3	6.6	3	6.5	3	5.8	4	6.5	5.5	6.6	NSX100B/F/N/H/S/L MA	12.5	LC1-D09	LRD 12	5.5/8
2.2	8.7	4	8.5	4	8.2	4	7.9	5.5	9			NSX100B/F/N/H/S/L MA	12.5	LC1-D09	LRD 14	7/10
										7.5	8.9	NSX100B/F/N/H/S/L MA	12.5	LC1-D12	LRD 14	7/10
3	11.5									7.5	8.9	NSX100HB1/HB2 MA	12.5	LC1-D40A	LRD 14	7/10
		5.5	11.5	5.5	11	5.5	10.4	7.5	12			NSX100B/F/N/H/S/L MA	12.5	LC1-D12	LRD 16	9/13
4	14.5	7.5	15.5	7.5	14	7.5	13.7	9	14			NSX100B/F/N/H/S/L MA	25	LC1-D18	LRD 21	12/18
				9	17	9	16.9	10	15			NSX100B/F/N/H/S/L MA	25	LC1-D18	LRD 21	12/18
5.5	20									10	11.5	NSX100B/F/N/H/S/L MA	25	LC1-D18	LRD 16	9/13
										10	11.5	NSX100HB1/HB2 MA	25	LC1-D40A	LRD313	9/13
7.5	28	11	22	11	21	11	20.1	11	18.4			NSX100B/F/N/H/S/L MA	25	LC1-D25	LRD 22	17/25
										15	17	NSX100B/F/N/H/S/L MA	25	LC1-D25	LRD 21	12/18
11	39									18.5	21.3	NSX100B/F/N/H/S/L MA	25	LC1-D32	LRD 22	17/25
										18.5	21.3	NSX100HB1/HB2 MA	25	LC1-D40A	LRD325	17/25
15	52	15	30	15	28	15	26.5	18.5	28.5			NSX100B/F/N/H/S/L MA	50	LC1-D32	LRD 32	23/32
								22	33	30	34.6	NSX100B/F/N/H/S/L MA	50	LC1-D40A	LRD340	30/40
18.5	64									30	34.6	NSX100HB1/HB2 MA	50	LC1-D80	LRD3355	30/40
										30	45	NSX100B/F/N/H/S/L MA	50	LC1-D40A	LRD350	37/50
22	75											NSX100B/F/N/H/S/L MA	50	LC1-D50A	LRD350	37/50
										37	42	NSX100B/F/N/H/S/L MA	50	LC1-D65A	LRD350	37/50
25	85									37	42	NSX100HB1/HB2 MA	50	LC1-D80	LRD3357	37/50
												NSX100B/F/N/H/S/L MA	100	LC1-D65A	LRD365	48/65
30	100															
										45	49	NSX100B/F/N/H/S/L/ HB1/HB2 MA	100	LC1-D80	LRD3357	37/50
												NSX100B/F/N/H/S/L MA	100	LC1-D80	LRD3363	63/80
												NSX100B/F/N/H/S/L MA	100	LC1-D95	LRD3365	80/104
										55	57	NSX100B/F/N/H/S/L/ HB1/HB2 MA	100	LC1-D115	LRD3561	55/70
										75	77	NSX100B/F/N/H/S/L/ HB1/HB2 MA	100	LC1-D115	LR9-D53 67	60/100

[1] For long starting (class 20), see the correspondence table for thermal relay.

[2] For 480V application consult us.

[3] Reversers : replace LC1 with LC2.

# Type 1 coordination (IEC 60947-4-1)

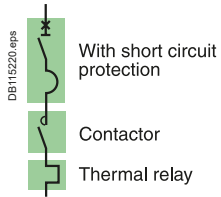

## NSX160 to NS1250 circuit breaker, contactor and thermal relay

### Direct-on-line starting

#### Reverser

"Iq" breaking performance: equal to the breaking capacity of the circuit breaker alone.

Starting<sup>[1]</sup>: normal, class 10.

B

Motors												Circuit breakers		Contactors <sup>[3]</sup>		Thermal relays <sup>[1]</sup>	
220/230 V		380 V		415 V		440 V <sup>[2]</sup>		500-525 V		660-690 V		Type	cal (A)	Type	Type	I <sub>rt</sub> (A)	
P (kW)	I (A)	P (kW)	I (A)	P (kW)	I (A)	P (kW)	I (A)	P (kW)	I (A)	P (kW)	I (A)						
37	125	55	105	75	135	75	124	75	110	90	100	NSX160B/F/N/H/S/L MA	150	LC1D-150	LR9-D53 69	90/150	
45	150	75	140					90	130			NSX250HB1/HB2 MA		LC1F-150	LR9-F53 69	100/160	
55	180	90	170	90	160	90	156	110	156	110	120	NSX 250B/F/N/H/S/L/HB1/HB2 MA	220	LC1F-185	LR9-F53 71	132/220	
		110	210	110	200	132	215					NSX 250B/F/N/H/S/L/HB1/HB2 MA	220	LC1F-225	LR9-F53 71	132/220	
								132	190	132	140	NSX 250B/F/N/H/S/L/HB1/HB2 MA	220	LC1F-265	LR9-F53 71	132/220	
75	250	132	250	132	230	160	256	160	228			NSX400F/N/H/S/L/HB1/HB2 Micrologic 1.3M	320	LC1F-265	LR9-F73 75	200/330	
90	312	160	300	160	270			200	281	200	220	NSX400F/N/H/S/L/HB1/HB2 Micrologic 1.3M	320	LC1F-330	LR9-F73 75	200/330	
110	360	200	380	220	380	220	360	220	310			NSX630F/N/H/S/L/HB1/HB2 Micrologic 1.3M	500	LC1F-400	LR9-F73 79	300/500	
										250	270	NSX630F/N/H/S/L/HB1/HB2 Micrologic 1.3M	500	LC1F-400	LR9-F73 75	200/330	
		220	420			250	401			335	335	NSX630F/N/H/S/L/HB1/HB2 Micrologic 1.3M	500	LC1F-500	LR9-F73 79	300/500	
150	480	250	480	250	430			315	445			NSX630F/N/H/S/L/HB1/HB2 Micrologic 1.3M	500	LC1F-500	LR9-F73 79	300/500	
						300	480					NSX630F/N/H/S/L/HB1/HB2 Micrologic 1.3M	500	LC1-F630	LR9-F73 81	380/630	
										375	400	NS800N/H Micrologic 5.0 - LR off	800	LC1-F630	LR9-F73 81	380/630	
160	520	300	570	300	510	335	540	355	500			NS1000L Micrologic 5.0 - LR off	1000				
								375	530								
								400	570								
200	630	335	630	335	580	375	590	450	630			NS800N/H Micrologic 5.0 - LR off	800	LC1-F630	LR9-F73 81	380/630	
												NS1000L Micrologic 5.0 - LR off	1000				
220	700	375	700	375	650	400	650					NS800N/H Micrologic 5.0 - LR off	800	LC1-F800	LR2-F83 83	500/800	
												NS1000L Micrologic 5.0 - LR off	1000				
		400	750	400	690	450	720					NS800N/H Micrologic 5.0 - LR off	800	LC1-F800	LR2-F83 83	500/800	
												NS1000L Micrologic 5.0 - LR off	1000	LC1-BL33			
										500	530	NS800N/H Micrologic 5.0 - LR off	800	LC1-BL33	LR2-F83 83	500/800	
										560	580	NS1000L Micrologic 5.0 - LR off	1000				
250	800	450	800	450	750			500	700			NS1000N/H Micrologic 5.0 - LR off	1000	LC1-BM33	LR2-F83 83	500/800	
								560	760								
		500	900	500	830	500	800	600	830			NS1000N/H Micrologic 5.0 - LR off	1000	LC1-BM33	LR2-F83 85	630/1000	
						560	900										
300	970	560	1000	560	920	600	960	670	920			NS1250N/H Micrologic 5.0 - LR off	1250	LC1-BP33	LR2-F83 85	630/1000	
		600	1100	600	1000	670	1080	750	1020								

[1] For long starting (class 20), see the correspondence table for thermal relay.

[2] For 480V application consult us.

[3] Reversers : replace LC1 with LC2.

# Type 1 coordination (IEC 60947-4-1)

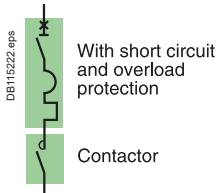

## GV4P circuit breaker and contactor

### Direct-on-line starting

#### Reverser

"Iq" breaking performance: equal to the breaking capacity of the circuit breaker alone.

Starting<sup>[1]</sup>: Direct on line normal start Class 10A/10.



Motors												Circuit breakers		Contactors <sup>[3]</sup>		Thermal relay <sup>[1]</sup>	
220/230 V		380 V		415 V		440 V		500-525 V		660-690 V		Type	cal (A)	Type	Type	I <sub>rt</sub> h (A)	
P (kW)	I (A)	P (kW)	I (A)	P (kW)	I (A)	P (kW)	I (A)	P (kW)	I (A)	P (kW)	I (A)						
0.37	1.8	0.37	1.2	0.37	1.1	0.37	1	0.55	1.2	0.75	1.2	GV4P, PE or PEM	2	LC1-D09		0.8/2	
		0.55	1.6	0.55	1.5	0.55	1.4	0.75	1.5	1	1.5	GV4P, PE or PEM	2	LC1-D09		0.8/2	
		0.75	2	0.75	1.8	0.75	1.7	1.1	2.4	1.1	2	1.5	2	GV4P, PE or PEM	2	LC1-D09	
0.55	2.8	1.1	2.8	1.1	2.6			1.5	2.6	2.2	2.8	GV4P, PE or PEM	3.5	LC1-D09		1.4/3.5	
		1.5	3.8	1.5	3.5	1.5	3.3			3	3.8	GV4P, PE or PEM	7	LC1-D09		2.9/7	
1.1	4.4	2.2	5.2	2.2	4.7	2.2	4.5	3	5	4	4.9	GV4P, PE or PEM	7	LC1-D09		2.9/7	
1.5	6.1	3	6.6	3	6.5	3	5.8	4	6.5	5.5	6.6	GV4P, PE or PEM	7	LC1-D09		2.9/7	
2.2	8.7	4	8.5	4	8.2	4	7.9	5.5	9	5.5	6.6	GV4P, PE or PEM	12.5	LC1-D25		5/12.5	
												GV4P, PE or PEM	12.5	LC1-D25		5/12.5	
3	11.5	5.5	11.5	5.5	11.1	5.5	10.5	7.5	12			GV4P, PE or PEM	12.5	LC1-D25		5/12.5	
												GV4P, PE or PEM	25	LC1-D25		10/25	
4	14.5	7.5	16	7.5	15	7.5	14	9	14			GV4P, PE or PEM	25	LC1-D25		10/25	
												GV4P, PE or PEM	25	LC1-D25		10/25	
5.5	20	11	23	11	21	11	20	11	18.4	10	11.5	GV4P, PE or PEM	25	LC1-D25		10/25	
												GV4P, PE or PEM	25	LC1-D25		10/25	
7.5	28	15	30	15	28	15	26.5	18.5	28.5			GV4P, PE or PEM	50	LC1-D40A		20/50	
												GV4P, PE or PEM	50	LC1-D40A		20/50	
11	39	18.5	37	18.5	35	22	37			30	34.6	GV4P, PE or PEM	50	LC1-D40A		20/50	
												GV4P, PE or PEM	50	LC1-D50A		20/50	
15	52					30	50					GV4P, PE or PEM	50	LC1-D65A		20/50	
												GV4P, PE or PEM	50	LC1-D65A		20/50	
18.5	64	30	58	30	53	37	60	37	55			GV4P, PE or PEM	80	LC1-D65A		40/80	
												GV4P, PE or PEM	80	LC1-D65A		40/80	
22	75	37	69	45	77	45	73	55	80			GV4P, PE or PEM	80	LC1-D80		40/80	
												GV4P, PE or PEM	115	LC1-D95		65/115	
30	95	55	97	55	93	55	90	75	106	90	93	GV4P, PE or PEM	80	LC1-D115		40/80	
												GV4P, PE or PEM	80	LC1-D115		40/80	
										55	57	GV4P, PE or PEM	115	LC1-D115		65/115	

[1] For long starting (class 20), see the correspondence table for thermal relay.

[2] For 480V application consult us.

[3] Reversers : replace LC1 with LC2.

# Type 1 coordination (IEC 60947-4-1)

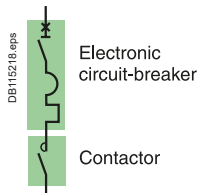

## NSX100 to NS1250 circuit breakers

### Direct-on-line starting

#### Reverser

"Iq" breaking performance: equal to the breaking capacity of the circuit breaker alone.

Starting	Standard IEC 60947-4-1		
	Micrologic	Normal (class)	Long (class)
2.2 M/2.3 M	6.2 M/6.3 M	5.0	
5. 10	5. 10	10	
20	20. 30 <sup>[3]</sup>	20	

Motors												Circuit breakers		Contactors <sup>[2]</sup>		
220/230 V		380 V		415 V		440 V <sup>[1]</sup>		500-525 V		660-690 V		Type	Trip unit	Irth (A)	Type	
P (kW)	I (A)	P (kW)	I (A)	P (kW)	I (A)	P (kW)	I (A)	P (kW)	I (A)	P (kW)	I (A)					
7.5	28	15	30	15	28	15	26.5	18.5	28.5			NSX100B/F/N/H/S/L	Micrologic 2.2 or 6.2	25/50	LC1-D32	
11	39	18.5	37	22	40	22	39	22	33	30	34.6	NSX100B/F/N/H/S/L/HB1/HB2	Micrologic 2.2 or 6.2	25/50	LC1-D40A	
		22	44	25	47			30	45	33	39	NSX100B/F/N/H/S/L/HB1/HB2	Micrologic 2.2 or 6.2	25/50	LC1-D50A	
15	52	30	59	30	55	30	51.5			37	42	NSX100B/F/N/H/S/L	Micrologic 2.2 or 6.2	48/80	LC1-D65A	
										37	42	NSX100HB1/HB2	Micrologic 2.2 or 6.2	48/80	LC1-D80	
18.5	64					37	64	37	55			NSX100B/F/N/H/S/L	Micrologic 2.2 or 6.2	48/80	LC1-D65A	
22	75	37	72	37	72	45	76	55	80	45	49	NSX100B/F/N/H/S/L/HB1/HB2	Micrologic 2.2 or 6.2	48/80	LC1-D80	
25	85	45	85									NSX100B/F/N/H/S/L/HB1/HB2	Micrologic 2.2 or 6.2	50/100	LC1-D95	
										55	60	NSX100B/F/N/H/S/L/HB1/HB2	Micrologic 2.2 or 6.2	50/100	LC1-D80	
30	100			55	100	55	96			75	80	NSX100B/F/N/H/S/L/HB1/HB2	Micrologic 2.2 or 6.2	50/100	LC1D-115 or LC1F-115	
37	125	55	105	75	135	75	124	75	110	90	100	NSX160B/F/N/H/S/L	Micrologic 2.2 or 6.2	70/150	LC1D-150 or LC1F-150	
45	150	75	140					90	130			NSX250HB1/HB2				
55	180	90	170	90	160	90	156	110	156	110	120	NSX 250B/F/N/H/S/L/HB1/HB2	Micrologic 2.2 or 6.2	100/220	LC1F-185	
		110	210	110	200	132	215					NSX 250B/F/N/H/S/L/HB1/HB2	Micrologic 2.2 or 6.2	100/220	LC1F-225	
								132	190	132	140	NSX 250B/F/N/H/S/L/HB1/HB2	Micrologic 2.2 or 6.2	100/220	LC1F-265	
										160	175					
75	250	132	250	132	230	160	256	160	228			NSX400F/N/H/S/L/HB1/HB2	Micrologic 2.3 or 6.3	160/320	LC1F-265	
90	312	160	300	160	270			200	281	200	220	NSX400F/N/H/S/L/HB1/HB2	Micrologic 2.3 or 6.3	160/320	LC1F-330	
								220	240							
110	360	200	380	220	380	220	360	220	310	250	270	NSX630F/N/H/S/L/HB1/HB2	Micrologic 2.3 or 6.3	250/500	LC1F-400	
		220	420			250	401	315	445	335	335	NSX630F/N/H/S/L/HB1/HB2	Micrologic 2.3 or 6.3	250/500	LC1F-500	
150	480	250	480	250	430			335	460			NSX630F/N/H/S/L/HB1/HB2	Micrologic 2.3 or 6.3	250/500	LC1F-500	
						300	480	355	500	375	400	NSX630F/N/H/S/L/HB1/HB2	Micrologic 2.3 or 6.3	250/500	LC1-F630	
								375	530	450	480					
160	520	300	570	300	510	335	540	400	570			NS800N/H	Micrologic 5.0	320/800	LC1-F630	
												NS1000L		400/1000		
200	630	335	630	335	580	375	590	450	630			NS800N/H	Micrologic 5.0	320/800	LC1-F630	
												NS1000L		400/1000		
220	700	375	700	375	650	400	650					NS800N/H	Micrologic 5.0	320/800	LC1-F800	
												NS1000L		400/1000		
		400	750	400	690	450	720					NS800N/H	Micrologic 5.0	320/800	LC1-F800	
												NS1000L		400/1000	LC1-BL33	
										500	530	NS800N/H	Micrologic 5.0	320/800	LC1-BL33	
										560	580	NS1000L		400/1000		
250	800	450	800	450	750			500	700			NS1000N/H	Micrologic 5.0	400/1000	LC1-BM33	
								560	760							
		500	900	500	830	500	800	600	830			NS1000N/H	Micrologic 5.0	400/1000	LC1-BM33	
						560	900									
300	970	560	1000	560	920	600	960	670	920			NS1250N/H	Micrologic 5.0	630/1250	LC1-BP33	
		600	1100	600	1000	670	1080	750	1020			NS1250N/H	Micrologic 5.0	630/1250	LC1-BP33	

[1] For 480V application consult us.

[2] Reversers : replace LC1 with LC2.

[3] For class 30 the contacteur rating shall be checked according to 30s thermal withstand (F range).

# Type 1 coordination (IEC 60947-4-1)

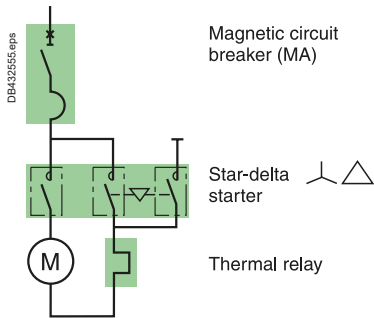

## GV4L/LE and NSX100 circuit breaker

### Star-delta starting

"Iq" breaking performance: equal to the breaking capacity of the circuit breaker alone.

Starting: normal.

Motors								Circuit breakers		Contactors		Thermal relays	
220/230 V		380 V		415 V		440 V [1]		Type	cal (A)	Type	Type	Irth (A)	
P (kW)	I (A)	P (kW)	I (A)	P (kW)	I (A)	P (kW)	I (A)						
0.55	2.8	1.1	2.8	1.1	2.6	1.5	3.1	GV4L or LE	3.5	LC3-D09	LRD 07	1.6/2.5	
		1.5	3.8	1.5	3.5			GV4L or LE	7	LC3-D09	LRD 07	1.6/2.5	
1.1	4.4	2.2	5.2	2.2	4.7	2.2	4.5	GV4L or LE	7	LC3-D09	LRD 08	2.5/4	
1.5	6.1	3	6.6	3	6.5	3	5.8	GV4L or LE	12.5	LC3-D09	LRD 08	2.5/4	
2.2	8.7	4	8.5	4	8.2	4	7.9	GV4L or LE	12.5	LC3-D09	LRD 10	4/6	
3	11.5	5.5	11.5	5.5	11.1	5.5	10.4	GV4L or LE	12.5	LC3-D09	LRD 12	5.5/8	
4	14.5	7.5	16	7.5	15	7.5	13.7	GV4L or LE	25.0	LC3-D09	LRD 14	7/10	
5.5	20			9	17	9	16.9	GV4L or LE	25.0	LC3-D12	LRD 16	9/13	
		11	23	11	21	11	20	GV4L or LE	25.0	LC3-D12	LRD 16	9/13	
7.5	28	15	30	15	28	15	26.5	GV4L or LE	50.0	LC3-D18	LRD 21	12/18	
11	39	18.5	37	22	40	22	37	GV4L or LE	50.0	LC3-D18	LRD 22	17/25	
		22	44	25	47			GV4L or LE	50.0	LC3-D32	LRD 32	23/32	
15	52			30	53	30	50	GV4L or LE	80.0	LC3-D32	LRD 32	23/32	
				30	53			GV4L or LE	80.0	LC3-D32	LRD 32	23/32	
18.5	64	30	58	37	64	37	60	GV4L or LE	80.0	3xLC1-D40A	LRD 340	30/40	
		37	69					GV4L or LE	80.0	3xLC1-D40A	LRD 350	37/50	
22	75	45	80	45	77	45	73	GV4L or LE	80.0	2xLC1-D50A + 1 xLC1D40A	LRD 350	37/50	
30	95	45	80	55	93	55	90	GV4L or LE	80.0	2xLC1-D65A + 1 xLC1D40A	LRD 365	48/65	
30	95	55	97	55	93	55	90	GV4L or LE	115	2xLC1-D65A + 1 xLC1D40A	LRD 365	48/65	
0.55	2.8	1.5	3.8	1.5	3.5	1.5	3.1	NSX100B/F/N/H/S/L MA	6.3	LC3-D09	LRD 07	1.6/2.5	
1.1	4.4	2.2	5.2	2.2	4.7	2.2	4.5	NSX100B/F/N/H/S/L MA	6.3	LC3-D09	LRD 08	2.5/4	
1.5	6.1	3	6.6	3	6.5	3	5.8	NSX100B/F/N/H/S/L MA	12.5	LC3-D09	LRD 08	2.5/4	
2.2	8.7	4	8.5	4	8.2	4	7.9	NSX100B/F/N/H/S/L MA	12.5	LC3-D09	LRD 10	4/6	
3	11.5	5.5	11.5	5.5	11.1	5.5	10.4	NSX100B/F/N/H/S/L MA	12.5	LC3-D09	LRD 12	5.5/8	
4	14.5	7.5	16	7.5	15	7.5	13.7	NSX100B/F/N/H/S/L MA	25	LC3-D09	LRD 14	7/10	
5.5	20			9	17	9	16.9	NSX100B/F/N/H/S/L MA	25	LC3-D12	LRD 16	9/13	
		11	23	11	21	11	20	NSX100B/F/N/H/S/L MA	25	LC3-D12	LRD 16	9/13	
7.5	28	15	30	15	28	15	26.5	NSX100B/F/N/H/S/L MA	50	LC3-D18	LRD 21	12/18	
11	39	18.5	37	22	40	22	37	NSX100B/F/N/H/S/L MA	50	LC3-D18	LRD 22	17/25	
		22	44	25	47			NSX100B/F/N/H/S/L MA	100	LC3-D32	LRD 32	23/32	
15	52			30	53	30	50	NSX100B/F/N/H/S/L MA	100	LC3-D32	LRD 32	23/32	
				30	53			NSX100B/F/N/H/S/L MA	100	LC3-D32	LRD 32	23/32	
18.5	64	30	58	37	64	37	60	NSX100B/F/N/H/S/L MA	100	3xLC1-D40A	LRD 340	30/40	
		37	69					NSX100B/F/N/H/S/L MA	100	3xLC1-D40A	LRD 350	37/50	
22	75	45	80	45	77	45	73	NSX100B/F/N/H/S/L MA	100	2xLC1-D50A + 1 xLC1D40A	LRD 350	37/50	
30	100			55	100	55	96	NSX100B/F/N/H/S/L MA	100	2xLC1-D65A + 1 xLC1D40A	LRD 365	48/65	

[1] 480V application : Consult us.



# Type 1 coordination (IEC 60947-4-1)

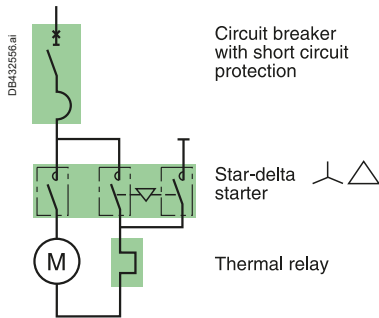

## NSX160 to NS1000 circuit breakers

### Star-delta starting

"Iq" breaking performance: equal to the breaking capacity of the circuit breaker alone.

Starting: normal.

Motors								Circuit breakers		Contactors	Thermal relays	
220/230 V		380 V		415 V		440 V <sup>[1]</sup>		Type	cal (A)	Type	Type	I <sub>rt</sub> h (A)
P (kW)	I (A)	P (kW)	I (A)	P (kW)	I (A)	P (kW)	I (A)					
		55	105					NSX160B/F/N/H/S/L MA	150	LC3-D80	LRD 3359	48/65
37	125			75	135	75	124	NSX160B/F/N/H/S/L MA	150	LC3-D80	LRD 3363	63/80
45	150	75	140					NSX160B/F/N/H/S/L MA	150	LC3-D115	LR9D 5367	60/100
		90	170	90	160	90	156	NSX 250B/F/N/H/S/L MA	220	LC3-D115	LR9D 5367	60/100
								NSX 250B/F/N/H/S/L MA	220	LC3-F115	LR9F 5367	
55	180					110	180	NSX 250B/F/N/H/S/L MA	220	LC3-D115	LR9D 5369	90/150
		110	210	110	200			NSX 250B/F/N/H/S/L MA	220	LC3-D115	LR9D 5369	90/150
						132	215	NSX 250B/F/N/H/S/L MA	220	LC3-F115	LR9F 5369	
								NSX 250B/F/N/H/S/L MA	220	LC3-D150	LR9D 5369	90/150
75	250	132	250	132	230			NSX400F/N/H/S/L Micrologic 1.3M	320	LC3-F150	LR9F 5369	
90	312	160	300	160	270	160	256	NSX400F/N/H/S/L Micrologic 1.3M	320	LC3-D150	LR9D 5369	90/150
110	360	200	380	220	380	220	360	NSX400F/N/H/S/L Micrologic 1.3M	320	LC3-F185	LR9F 5371	132/220
		220	420			250	401	NSX630F/N/H/S/L Micrologic 1.3M	500	LC3-F265	LR9F 7375	200/330
150	480	250	480	250	430			NSX630F/N/H/S/L Micrologic 1.3M	500	LC3-F265	LR9F 7375	200/330
						300	480	NSX630F/N/H/S/L Micrologic 1.3M	500	LC3-F330	LR9-F73 75	200/330
160	520	300	570	300	510	335	540	NSX630F/N/H/S/L Micrologic 1.3M	500	LC3-F330	LR9F 7375	200/330
								NS800N/H Micrologic 5.0 - LR off	800	LC3-F400	LR9F 7375	200/330
								NS1000L Micrologic 5.0 - LR off	1000			
				335	580	375	590	NS800N/H Micrologic 5.0 - LR off	800	LC3-F400	LR9F 7379	300/500
								NS1000L Micrologic 5.0 - LR off	1000			

[1] 480V application : Consult us.



# Type 1 coordination (IEC 60947-4-1)

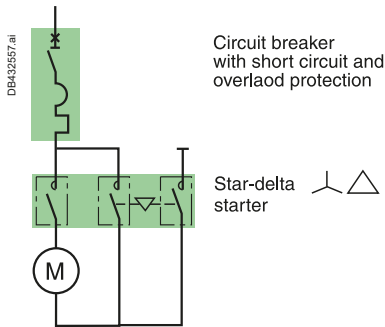

## GV4P/PE/PEM, NSX100 to NS1000 circuit breakers, contactors

### Star-delta starting

"Iq" breaking performance: equal to the breaking capacity of the circuit breaker alone.

Starting: normal.



Motors								Circuit breakers				Contactors	
220/230 V		380 V		415 V		440 V [1]		Type	Trip unit	I <sub>rt</sub> h (A)	Type		
P (kW)	I (A)	P (kW)	I (A)	P (kW)	I (A)	P (kW)	I (A)						
0.37	1.8	0.37	1.2	0.37	1.1	0.37	1	GV4P, PE or PEM	2	0.8/2	LC3-D09		
		0.55	1.6	0.55	1.5	0.55	1.4	GV4P, PE or PEM	2	0.8/2	LC3-D09		
		0.75	2	0.75	1.8	0.75	1.7	GV4P, PE or PEM	2	0.8/2	LC3-D09		
0.55	2.8	1.1	2.8	1.1	2.6	1.1	2.4	GV4P, PE or PEM	3.5	1.4/3.5	LC3-D09		
		1.5	3.8	1.5	3.5	1.5	3.3	GV4P, PE or PEM	3.5	1.4/3.5	LC3-D09		
		2.2	5.2	2.2	4.7	2.2	4.5	GV4P, PE or PEM	7	2.9/7	LC3-D09		
1.1	4.4	2.2	5.2	2.2	4.7	2.2	4.5	GV4P, PE or PEM	7	2.9/7	LC3-D09		
1.5	6.1	3	6.6	3	6.5	3	5.8	GV4P, PE or PEM	7	2.9/7	LC3-D09		
2.2	8.7	4	8.5	4	8.2	4	7.9	GV4P, PE or PEM	12.5	5/12.5	LC3-D09		
3	11.5	5.5	11.5	5.5	11.1	5.5	10.5	GV4P, PE or PEM	12.5	5/12.5	LC3-D09		
4	14.5	7.5	16	7.5	15	7.5	14	GV4P, PE or PEM	25	10/25	LC3-D12		
		9	17	9	16.9	9	16.9	GV4P, PE or PEM	25	10/25	LC3-D12		
		11	21	11	20	11	20	GV4P, PE or PEM	25	10/25	LC3-D18		
7.5	28	15	30	15	28	15	26.5	GV4P, PE or PEM	50	20/50	LC3-D18		
11	39	18.5	37	18.5	35	22	37	GV4P, PE or PEM	50	20/50	LC3-D18		
		22	44	22	40	22	40	GV4P, PE or PEM	50	20/50	LC3-D18		
		30	53	30	50	30	50	GV4P, PE or PEM	50	20/50	LC3-D18		
15	52			30	53	30	50	GV4P, PE or PEM	50	20/50	LC3-D32		
18.5	64	30	58	37	64	37	60	GV4P, PE or PEM	80	40/80	3xLC1-D40A		
		37	69	45	77	45	73	GV4P, PE or PEM	80	40/80	3xLC1-D40A		
		45	80					GV4P, PE or PEM	115	65/115	2xLC1-D50A + 1xLC1D40A		
30	95	55	97	55	93	55	90	GV4P, PE or PEM	115	65/115	2xLC1-D50A + 1xLC1D40A		
		7.5	28	15	30	15	28	15	26.5	NSX100B/F/N/H/S/L	Micrologic 2.2M or 6.2E-M	25/50	LC3-D18
		11	39	18.5	37	22	40	22	39	NSX100B/F/N/H/S/L	Micrologic 2.2M or 6.2E-M	25/50	LC3-D18
		22	44	25	47			NSX100B/F/N/H/S/L	Micrologic 2.2M or 6.2E-M	25/50	LC3-D18		
15	52	30	55	30	55	30	51.5	NSX100B/F/N/H/S/L	Micrologic 2.2M or 6.2E-M	50/100	LC3-D32		
		30	55	30	55	30	55	NSX100B/F/N/H/S/L	Micrologic 2.2M or 6.2E-M	50/100	LC3-D32		
		18.5	64	30	59	37	66	37	64	NSX100B/F/N/H/S/L	Micrologic 2.2M or 6.2E-M	50/100	3xLC1-D40A
		37	72					NSX100B/F/N/H/S/L	Micrologic 2.2M or 6.2E-M	50/100	2xLC1-D50A + 1xLC1D40A		
22	75			45	80	45	76	NSX100B/F/N/H/S/L	Micrologic 2.2M or 6.2E-M	50/100	2xLC1-D50A + 1xLC1D40A		
								NSX100B/F/N/H/S/L	Micrologic 2.2M or 6.2E-M	50/100	2xLC1-D50A + 1xLC1D40A		
								NSX100B/F/N/H/S/L	Micrologic 2.2M or 6.2E-M	50/100	2xLC1-D65A + 1xLC1D40A		
30	100			55	100	55	96	NSX100B/F/N/H/S/L	Micrologic 2.2M or 6.2E-M	50/100	2xLC1-D65A + 1xLC1D40A		
				55	105			NSX160B/F/N/H/S/L	Micrologic 2.2M or 6.2E-M	70/150	LC3-D80		
				75	140	75	135	75	124	NSX160B/F/N/H/S/L	Micrologic 2.2M or 6.2E-M	70/150	LC3-D80
45	150	75	140					NSX160B/F/N/H/S/L	Micrologic 2.2M or 6.2E-M	70/150	LC3-D115 or LC3-F115		
		90	170	90	160	90	156	NSX 250B/F/N/H/S/L	Micrologic 2.2M or 6.2E-M	100/220	LC3-D115 or LC3-F115		
		110	210	110	200	110	180	NSX 250B/F/N/H/S/L	Micrologic 2.2M or 6.2E-M	100/220	LC3-D115 or LC3-F115		
75	250	132	250	132	230			NSX 250B/F/N/H/S/L	Micrologic 2.2M or 6.2E-M	100/220	LC3-D150 or LC3-F150		
		160	300	160	270	160	256	NSX400F/N/H/S/L	Micrologic 2.3M or 6.3E-M	160/320	LC3-D150 or LC3-F150		
		200	380	220	380	220	360	NSX400F/N/H/S/L	Micrologic 2.3M or 6.3E-M	160/320	LC3F-185		
110	360	220	420			250	401	NSX630F/N/H/S/L	Micrologic 2.3M or 6.3E-M	250/500	LC3-F265		
		250	480	250	430			NSX630F/N/H/S/L	Micrologic 2.3M or 6.3E-M	250/500	LC3-F265		
						300	480	NSX630F/N/H/S/L	Micrologic 2.3M or 6.3E-M	250/500	LC3-F330		
150	480	250	480			300	480	NSX630F/N/H/S/L	Micrologic 2.3M or 6.3E-M	250/500	LC3-F330		
				300	510	335	540	NS800N/H	Micrologic 5.0	320/800	LC3-F400		
				335	580	375	590	NS1000L	Micrologic 5.0	400/1000	LC3-F400		
160	520							NS800N/H	Micrologic 5.0	320/800	LC3-F400		
								NS1000L	Micrologic 5.0	400/1000	LC3-F400		
								NS1000L	Micrologic 5.0	400/1000	LC3-F400		

[1] 480V application : Consult us.

# Type 1 coordination (IEC 60947-4-1) for AC1 Utilisation category: non-inductive or slightly inductive loads

## $U_e \leq 440 \text{ V AC}$

"Iq" performance: equal to the breaking capacity of the circuit breaker alone.

Ie max [1]	Circuit breakers Type	Iq 440V (kA)				Contactor
		According to circuit breaker breaking capacity	Trip unit	Rating (A)	Ir (A)	
40°						
40	Compact NSX100 B/F/N	25/35/50	Micrologic 2.2 / 5.2	40	18..40	LC1D40A
80	Compact NSX100 B/F/N	25/35/50	Micrologic 2.2 / 5.2	100	40..100	LC1D50A or 65A
100	Compact NSX100 B/F/N	25/35/50	Micrologic 2.2 / 5.2	100	40..100	LC1D80
160	Compact NSX160 B/F/N	25/35/50	Micrologic 2.2 / 5.2	160	63..160	LC1D80 LC1D115
250	Compact NSX250 B/F/N	35/50	Micrologic 2.3 / 5.3	250	100..250	LC1D115
275	Compact NSX400 F/N	35/50	Micrologic 2.3 / 5.3	400	160..400	LC1F185
315	Compact NSX400 F/N	35/50	Micrologic 2.3 / 5.3	400	160..400	LC1F225
350	Compact NSX400 F/N	35/50	Micrologic 2.3 / 5.3	400	160..400	LC1F265
400	Compact NSX400 F/N	35/50	Micrologic 2.3 / 5.3	400	160..400	LC1F330
500	Compact NSX630 F/N	35/50	Micrologic 2.3 / 5.3	630	150..630	LC1F400
630	Compact NSX630 F/N	35/50	Micrologic 2.3 / 5.3	630	150..630	LC1F500
800	Compact NS800L	130	Micrologic 2.0 / 5.0 / 6.0 / 7.0	800	320..800	LC1F630
1000	Compact NS1000L	130	Micrologic 2.0 / 5.0 / 6.0 / 7.0	1000	400..1000	LC1F630 LC1F1250
1250	Masterpact MTZ1 12 H1/H2/H3	42/50/50	Micrologic 5/6/7.0X li "fast"	1250	500..1250	LC1F1400
1400	Masterpact MTZ1 16 H1/H2/H3	42/50/50	Micrologic 5/6/7.0X li "fast"	1600	630..1600	LC1F1400
1600	Masterpact MTZ1 16 H1/H2/H3 Masterpact MTZ2 16 N1/H1/H2	42/50/50	Micrologic 5/6/7.0X li "fast"	1600	630..1600	LC1F1700
1700	Masterpact MTZ2 20 N1/H1/H2	42/50/50	Micrologic 5/6/7.0X li "fast"	2000	800..2000	LC1F1700
2000	Masterpact MTZ2 20 N1/H1/H2	42/50/50	Micrologic 5/6/7.0X li "fast"	2000	800..2000	LC1F1700
2100	Masterpact MTZ2 25 N1/H1/H2	42/50/50	Micrologic 5/6/7.0X li "fast"	2500	1000..2500	LC1F2100

[1] Values for Fix circuit breaker with IEC60947-1 Tables 9 & 10 cross section of conductors. Check derating of circuit breaker and contactor according to ambient temperature and installation.

# Protection of motor circuits with fuses: introduction

**Example:**

An INF•160 can receive BS fuse-links in sizes A2, A3 or A4, which correspond to the following ratings:

- A2 size:
  - 2 to 32 A for gG fuse-links
  - 32M35 to 32M63 for gM fuse-links
- A3 size:
  - 35 to 63 A for gG fuse-links
  - 63M80 to 63M100 for gM fuse-links
- A4 size:
  - 80 to 100 A for gG fuse-links
  - 100M125 to 100M200 for gM fuse-links.

The tables on page B-62 to page B-66 directly indicate the correct selection of fuse-links and Fupact switches depending on the distribution circuit rating and the motor rating (for direct-on-line starting).

## Fuse size table

The table below indicates the minimum and maximum fuse sizes depending on the rating of the switch and the applicable reference standard.

	BS min.	BS max.	DIN min.	DIN max.	NFC min.	NFC max.
INF•32	A1	A2			10 x 38	14 x 51
INFD40			000	000		
INFC50					14 x 51	14 x 51
INF•63	A2	A3	000	000	22 x 58	22 x 58
INF•100	A2	A4				
INFC125					22 x 58	22 x 58
INF•160	A2	A4	000	00		
INF•200	B1	B2	0	0		
INF•250	B1	B3	0	1		
INF•400	B1	B4	0	2		
INF•630	C1	C3	3	3		
INF•800	C1	C3	3	3		
ISFT100N			000	000		
ISFT100			000	000		
ISF•160			000	00		
ISF•250			1	1		
ISF•400			2	2		
ISF•630			3	3		

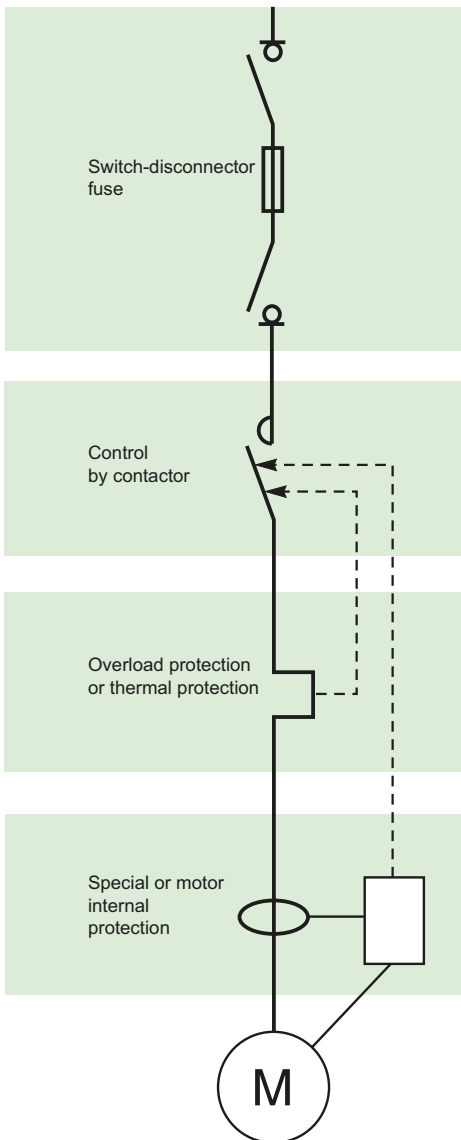

## Protection of motor feeders

A motor feeder is generally made up of:

- a control contactor
- a thermal relay for overcurrent protection
- a short-circuit protection device
- a disconnection device capable of interrupting load currents.

Fupact switch-disconnector fuses are ideally suited to perform the last two functions in the list. What is more, Fupact devices are totally compatible with the IEC 60204 machine directive.

**Additional specific protection:**

- fault limiting protection (while the motor is running)
- fault prevention (monitoring of motor insulation with motor off).

### Fupact characteristics

The local emergency-off switch must have the AC23 characteristic for the rated motor current.

Motor starting characteristics are the following:

- peak current: 8 to 10 I<sub>n</sub>
- duration of peak current: 20 to 30 ms
- starting current I<sub>d</sub>: 4 to 8 I<sub>n</sub>
- starting time t<sub>d</sub>: 2 to 4 seconds.

Short-circuit protection of motors is ensured by aM or gM [1] fuse-links that are sized to take into account the above characteristics.

Fupact offers a wide range of fuse utilisations, whatever the applicable reference standard.

[1] A gM fuse-link is in fact simply a derated gG fuse-link.

### Coordination of devices on the motor feeder

■ Thermal protection of:

- motor
- conductors
- switch
- fuse

is ensured by the thermal relay on the contactor.

■ Overload (or short-circuit) protection of:

- motor
- conductors
- switch
- thermal relay

is ensured by the fuse.

To ensure a high level of operational quality, it is important to ensure **coordination of the devices** on the motor feeder in compliance with standard IEC 60947-4.

The equipment manufacturers provide type-1 and type-2 coordination tables between fuse-links, contactors and thermal relays.

NOTE : Proposed fuses are based on 4 poles 50 Hz induction motors direct on line start I<sub>d</sub>/I<sub>n</sub> ≤ 7 for 10 sec. The choice of fuses and overload relay shall be checked according to the actual motor's characteristic.

## Protection of motor circuits

with BS fuses

## Selection tables for Fupact devices and associated BS fuse-links

**Example:**

A 37 kW motor supplied at 415 V is protected by 160 A gM fuse-links.

This type of fuse-link may be mounted on a Fupact INFB100 or higher.

See the grey section in the table opposite.

230/240 V					415V				
P(kW)	(HP)	In (A)	Fupact	gG/gM	P(kW)	(HP)	In (A)	Fupact	gG/gM
0.37	0.5	1.9	INFB32	gG 6	0.37	0.5	1.1	INFB32	gG 4
1	0.7	2.7	INFB32	gG 10	1	0.7	1.5	INFB32	gG 6
0.8	1	3.6	INFB32	gG 16	0.8	1	2	INFB32	gG 10
1.1	1.5	4.5	INFB32	gG 16	1.1	1.5	2.5	INFB32	gG 10
1.5	2	6.3	INFB32	gG 20	1.5	2	3.5	INFB32	gG 16
2.2	2.9	9	INFB32	20M25	2.2	2.9	5	INFB32	gG 16
3	4	11.7	INFB32	20M32	3	4	6.5	INFB32	gG 20
4	5.3	15.2	INFB32	32M40	4	5.3	8.4	INFB32	20M25
5.5	7.3	19.8	INFB32	32M50	5.5	7.3	11	INFB32	20M32
7.5	10	26	INFB32	32M50	7.5	10	14.4	INFB32	32M40
10	13	34	INFB32	63M80	10	13.3	19.1	INFB32	32M50
11	15	38	INFB63	63M80	11	15	21	INFB32	32M50
15	20	51	INFB63	63M100	15	20	28	INFB32	32M63
18.5	25	63	INFB100	100M160	18.5	25	35	INFB63	63M80
22	29	74	INFB100	100M160	22	29	41	INFB63	63M80
30	40	99	INFB200	gG 200	30	40	55	INFB63	63M100
37	49	125	INFB200	200M250	37	49	69	INFB100	100M160
45	60	144	INFB200	200M250	45	60	80	INFB100	100M160
55	73	177	INFB250	315M400	55	73	98	INFB200	gG 200
75	100	245	INFB250	315M400	75	100	136	INFB200	200M250
90	120	296	INFB400	400M450	90	120	164	INFB200	200M315
110	147	354	INFB630	gG 630	110	147	196	INFB250	315M400
132	176	408	INFB800	gG 800	132	176	226	INFB250	315M400
150	200	484	INFB800	gG 800	150	200	268	INFB400	400M500
160	213	496	INFB800	gG 800	160	213	275	INFB400	400M500
					200	267	358	INFB630	gG 630
					240	320	428	INFB800	gG 800
					280	373	488	INFB800	gG 800

B

# Protection of motor circuits

with NFC fuses

## Selection tables for Fupact devices and associated NFC fuse-links

**Example:**

A 30 kW motor supplied at 690 V is protected by:

- 80 AgG fuse-links
- 32 A aM fuse-links.

Both types of fuse-links may be mounted on a Fupact INFC63<sup>[1]</sup> or higher.

See the grey section in the table on following page.

230/240 V						
P(kW)	(HP)	In (A)	Fupact	gG	Fupact	aM
0.37	0.49	1.9	INFC32	6	INFC32	2
0.55	0.73	2.7	INFC32	10	INFC32	4
0.75	1	3.6	INFC32	16	INFC32	4
1.1	1.5	4.5	INFC32	16	INFC32	6
1.5	2	6.3	INFC32	20	INFC32	8
2.2	2.9	9	INFC32	25	INFC32	10
3	4	11.7	INFC32	32	INFC32	12
4	5.3	15.2	INFC32	40	INFC32	16
5.5	7.3	19.8	INFC32	50	INFC32	20
7.5	10	26	INFC50	50	INFC32	32
10	13	34	INFC63	80	INFC50	40
11	15	38	INFC63	80	INFC50	40
15	20	51	INFC63	100	INFC63	63
18.5	25	63	-	160	INFC125	80
22	29	74	-	160	INFC125	80
30	40	99	-	200	INFC125	100
37	49	125	-	250	INFC125	125

380/400V						
P(kW)	(HP)	In (A)	Fupact	gG	Fupact	aM
0.37	0.49	1.1	INFC32	4	INFC32	2
0.55	0.73	1.6	INFC32	6	INFC32	2
0.75	1	2.2	INFC32	10	INFC32	4
1.1	1.5	2.7	INFC32	10	INFC32	4
1.5	2	3.8	INFC32	16	INFC32	4
2.2	2.9	5.5	INFC32	16	INFC32	6
3	4	7.1	INFC32	20	INFC32	8
4	5.3	9.2	INFC32	25	INFC32	10
5.5	7.3	12	INFC32	32	INFC32	12
7.5	10	16	INFC32	40	INFC32	16
10	13	21	INFC32	50	INFC32	25
11	15	23	INFC32	50	INFC32	25
15	20	31	INFC63	80	INFC32	32
18.5	25	38	INFC63	80	INFC50	40
22	29	45	INFC63	100	INFC50	50
30	40	60	INFC63	125	INFC63	63
37	49	75	-	160	INFC125	80
45	60	87	-	200	INFC125	100
55	73	107	-	200	INFC125	125

415 V						
P(kW)	(HP)	In (A)	Fupact	gG	Fupact	aM
0.37	0.49	1.1	INFC32	4	INFC32	2
0.55	0.73	1.5	INFC32	6	INFC32	2
0.75	1	2	INFC32	6	INFC32	2
1.1	1.5	2.5	INFC32	10	INFC32	4
1.5	2	3.5	INFC32	16	INFC32	4
2.2	2.9	5	INFC32	16	INFC32	6
3	4	6.5	INFC32	20	INFC32	8
4	5.3	8.4	INFC32	25	INFC32	10
5.5	7.3	11	INFC32	32	INFC32	12
7.5	10	14	INFC32	40	INFC32	16
10	13	19	INFC32	50	INFC32	25
11	15	21	INFC32	50	INFC32	25
15	20	28	INFC63	63	INFC32	32
18.5	25	35	INFC63	80	INFC50	40
22	29	41	INFC63	80	INFC50	50
30	40	55	INFC63	100	INFC63	63
37	49	69	-	160	INFC125	80
45	60	80	-	160	INFC125	80
55	73	98	-	200	INFC125	100

440 V						
P(kW)	(HP)	In (A)	Fupact	gG	Fupact	aM
0.37	0.49	1	INFC32	4	INFC32	2
0.55	0.73	1.4	INFC32	6	INFC32	2
0.75	1	1.9	INFC32	6	INFC32	2
1.1	1.5	2.4	INFC32	10	INFC32	4
1.5	2	3.3	INFC32	10	INFC32	4
2.2	2.9	4.7	INFC32	16	INFC32	6
3	4	6.1	INFC32	16	INFC32	6
4	5.3	7.9	INFC32	20	INFC32	8
5.5	7.3	10.4	INFC32	25	INFC32	10
7.5	10	14	INFC32	40	INFC32	16
10	13	18	INFC50	50	INFC32	20
11	15	20	INFC50	50	INFC32	20
15	20	26	INFC63	63	INFC32	32
18.5	25	33	INFC63	80	INFC50	40
22	29	39	INFC63	80	INFC50	40
30	40	52	INFC63	100	INFC50	50
37	49	65	-	160	INFC125	80
45	60	75	-	160	INFC125	80
55	73	92	-	200	INFC125	100



[1] Fupact is designed to allow overrated protection.

## Protection of motor circuits

with NFC fuses

B

500 V							525-550 V						
P(kW)	(HP)	In (A)	Fupact	gG	Fupact	aM	P(kW)	(HP)	In (A)	Fupact	gG	Fupact	aM
0.37	0.49	0.9	INFC32	4	INFC32	2	0.37	0.49	0.8	INFC63	4	INFC32	2
0.55	0.73	1.2	INFC32	4	INFC32	2	0.55	0.73	1.1	INFC63	4	INFC32	2
0.75	1	1.5	INFC32	6	INFC32	2	0.75	1	1.4	INFC63	6	INFC32	2
1.1	1.5	2.2	INFC32	6	INFC32	2	1.1	1.5	2.1	INFC63	6	INFC32	2
1.5	2	2.9	INFC32	10	INFC32	4	1.5	2	2.8	INFC63	10	INFC32	4
2.2	2.9	3.9	INFC32	10	INFC32	4	2.2	2.9	3.7	INFC63	10	INFC32	4
3	4	5.2	INFC32	16	INFC32	6	3	4	4.9	INFC63	16	INFC32	6
4	5.3	6.8	INFC32	20	INFC32	8	4	5.3	6.5	INFC63	20	INFC32	8
5.5	7.3	9.2	INFC32	25	INFC32	10	5.5	7.3	8.7	INFC63	25	INFC32	10
7.5	10	12	INFC32	32	INFC32	12	7.5	10	12	INFC63	32	INFC32	12
10	13	16	INFC32	32	INFC32	16	10	13	15	INFC63	32	INFC32	16
11	15	18	INFC32	40	INFC32	20	11	15	17	INFC63	40	INFC32	20
15	20	23	INFC63	50	INFC32	25	15	20	22	INFC63	50	INFC32	25
18.5	25	28	INFC63	63	INFC50	32	18.5	25	27	INFC63	63	INFC63	32
22	29	33	INFC63	80	INFC50	40	22	29	31	INFC63	80	INFC63	40
30	40	45	INFC63	100	INFC63	50	30	40	43	-	100	INFC63	50
37	49	53	INFC63	100	INFC63	63	37	49	50	-	100	INFC63	63
45	60	64	-	160	INFC125	80	45	60	61	-	125	INFC63	63
55	73	78	-	160	INFC125	80	55	73	74	-	160	INFC125	80

660-690V						
P(kW)	(HP)	In (A)	Fupact	gG	Fupact	aM
0.37	0.49	0.7	INFC63	2	INFC32	2
0.55	0.73	0.9	INFC63	4	INFC32	2
0.75	1	1.1	INFC63	4	INFC32	2
1.1	1.5	1.6	INFC63	6	INFC32	2
1.5	2	2.2	INFC63	6	INFC32	4
2.2	2.9	2.8	INFC63	10	INFC32	4
3	4	3.8	INFC63	10	INFC32	6
4	5.3	4.9	INFC63	16	INFC32	6
5.5	7.3	6.7	INFC63	20	INFC32	8
7.5	10	9	INFC63	25	INFC32	10
10	13	12	INFC63	32	INFC32	12
11	15	13	INFC63	32	INFC32	16
15	20	17	INFC63	40	INFC32	20
18.5	25	22	INFC63	50	INFC32	25
22	29	24	INFC63	50	INFC63	25
30	40	32	INFC63	80	INFC63	32
37	49	39	INFC63	80	INFC63	40
45	60	47	-	100	INFC63	50
55	73	57	-	125	INFC63	63
75	100	77	-	160	INFC125	80

# Protection of motor circuits

with DIN fuses

## Selection tables for Fupact devices and associated DIN fuse-links

### Example:

A 75 kW motor supplied at 500 V is protected by:

■ 200 A gG fuse-links

■ 125 A aM fuse-links.

Both types of fuse-links may be mounted on a Fupact INFD200 or higher.

See the grey section in the table below.

230/240 V AC							380/400V AC						
P(kW)	(HP)	In (A)	Fupact	gG	Fupact	aM	P(kW)	(HP)	In (A)	Fupact	gG	Fupact	aM
0.37	0.49	1.9	INFD40	6	INFD40	2	0.37	0.49	1.1	INFD40	4	INFD40	2
0.55	0.73	2.7	INFD40	10	INFD40	4	0.55	0.73	1.6	INFD40	6	INFD40	2
0.75	1	3.6	INFD40	16	INFD40	4	0.75	1	2.2	INFD40	10	INFD40	4
1.1	1.5	4.5	INFD40	16	INFD40	6	1.1	1.5	2.7	INFD40	10	INFD40	4
1.5	2	6.3	INFD40	20	INFD40	8	1.5	2	3.8	INFD40	16	INFD40	4
2.2	2.9	9.0	INFD40	25	INFD40	10	2.2	2.9	5.5	INFD40	16	INFD40	6
3	4	11.7	INFD40	32	INFD40	12	3	4	7.1	INFD40	20	INFD40	8
4	5.3	15.2	INFD40	40	INFD40	16	4	5.3	9.2	INFD40	25	INFD40	10
5.5	7.3	19.8	INFD40	50	INFD40	20	5.5	7.3	12	INFD40	32	INFD40	12
7.5	10	26	INFD40	50	INFD40	32	7.5	10	16	INFD40	40	INFD40	16
10	13	34	INFD40	80	INFD40	40	10	13	21	INFD40	50	INFD40	25
11	15	38	INFD40	80	INFD40	40	11	15	23	INFD40	50	INFD40	25
15	20	51	INFD63	100	INFD63	63	15	20	31	INFD40	80	INFD40	32
18.5	25	63	INFD160	160	INFD160	80	18.5	25	38	INFD40	80	INFD40	40
22	29	74	INFD160	160	INFD160	80	22	29	45	INFD63	100	INFD63	50
30	40	99	INFD200	200	INFD160	100	30	40	60	INFD63	125	INFD63	63
37	49	125	INFD200	250	INFD160	125	37	49	75	INFD160	160	INFD160	80
45	60	144	INFD200	250	INFD160	160	45	60	87	INFD200	200	INFD160	100
55	73	177	INFD250	355	INFD200	200	55	73	107	INFD200	200	INFD160	125
75	100	245	INFD400	400	INFD400	250	75	100	149	INFD200	250	INFD160	160
90	120	296	INFD400	450	INFD400	315	90	120	179	INFD250	355	INFD200	200
110	147	354	INFD630	630	INFD400	355	110	147	214	INFD400	400	INFD250	250
132	176	408	INFD630	800	INFD630	450	132	176	247	INFD400	450	INFD250	250
150	200	484	INFD630	800	INFD630	500	150	200	293	INFD400	500	INFD400	315
160	213	496	INFD630	800	INFD630	500	160	213	300	INFD630	630	INFD400	315
200	267	646	-	-	INFD800	800	200	267	391	INFD630	800	INFD400	400
							240	320	467	INFD630	800	INFD630	500
							280	373	533	-	-	INFD630	630
							300	400	573	-	-	INFD630	630
							320	427	588	-	-	INFD630	630

415 V AC						
P(kW)	(HP)	In (A)	Fupact	gG	Fupact	aM
0.37	0.49	1.1	INFD40	4	INFD40	2
0.55	0.73	1.5	INFD40	6	INFD40	2
0.75	1	2	INFD40	10	INFD40	2
1.1	1.5	2.5	INFD40	10	INFD40	4
1.5	2	3.5	INFD40	16	INFD40	4
2.2	2.9	5	INFD40	16	INFD40	6
3	4	6.5	INFD40	20	INFD40	8
4	5.3	8.4	INFD40	25	INFD40	10
5.5	7.3	11	INFD40	32	INFD40	12
7.5	10	14	INFD40	40	INFD40	16
10	13	19	INFD40	50	INFD40	25
11	15	21	INFD40	50	INFD40	25
15	20	28	INFD40	63	INFD40	32
18.5	25	35	INFD40	80	INFD40	40
22	29	41	INFD63	80	INFD63	50
30	40	55	INFD63	100	INFD63	63
37	49	69	INFD160	160	INFD160	80
45	60	80	INFD160	160	INFD160	80
55	73	98	INFD200	200	INFD160	100
75	100	136	INFD200	250	INFD160	160
90	120	164	INFD250	315	INFD200	200
110	147	196	INFD250	355	INFD200	200
132	176	226	INFD400	400	INFD250	250
150	200	268	INFD400	450	INFD400	315
160	213	275	INFD400	500	INFD400	315
200	267	358	INFD630	630	INFD400	400
240	320	428	INFD630	800	INFD630	450
280	373	488	INFD630	800	INFD630	500
300	400	525	-	-	INFD630	630
320	427	538	-	-	INFD630	630
355	473	605	-	-	INFD630	630
375	500	610	-	-	INFD630	630

440 V AC						
P(kW)	(HP)	In (A)	Fupact	gG	Fupact	aM
0.37	0.49	1	INFD40	4	INFD40	2
0.55	0.73	1.4	INFD40	6	INFD40	2
0.75	1	1.9	INFD40	6	INFD40	2
1.1	1.5	2.4	INFD40	10	INFD40	4
1.5	2	3.3	INFD40	10	INFD40	4
2.2	2.9	4.7	INFD40	16	INFD40	6
3	4	6.1	INFD40	16	INFD40	6
4	5.3	7.9	INFD40	20	INFD40	8
5.5	7.3	10.4	INFD40	25	INFD40	10
7.5	10	14	INFD40	40	INFD40	16
10	13	18	INFD40	50	INFD40	20
11	15	20	INFD40	50	INFD40	20
15	20	26	INFD40	63	INFD40	32
18.5	25	33	INFD40	80	INFD40	40
22	29	39	INFD40	80	INFD40	40
30	40	52	INFD63	100	INFD63	50
37	49	65	INFD160	160	INFD160	80
45	60	75	INFD160	160	INFD160	80
55	73	92	INFD160	200	INFD160	100
75	100	128	INFD200	250	INFD160	125
90	120	155	INFD250	315	INFD160	160
110	147	185	INFD250	355	INFD200	200
132	176	213	INFD400	400	INFD250	250
150	200	253	INFD400	450	INFD400	250
160	213	259	INFD400	500	INFD400	315
200	267	338	INFD630	630	INFD400	355
240	320	404	INFD630	800	INFD630	400
280	373	460	INFD630	800	INFD630	450
300	400	495	INFD630	800	INFD630	500
320	427	507	-	-	INFD630	500
355	473	560	-	-	INFD630	630
375	500	575	-	-	INFD630	630
400	533	611	-	-	INFD630	630

500 V AC						
P(kW)	(HP)	In (A)	Fupact	gG	Fupact	aM
0.37	0.49	0.9	INFD40	4	INFD40	2
0.55	0.73	1.2	INFD40	4	INFD40	2
0.75	1	1.5	INFD40	6	INFD40	2
1.1	1.5	2.2	INFD40	6	INFD40	2
1.5	2	2.9	INFD40	10	INFD40	4
2.2	2.9	3.9	INFD40	10	INFD40	4
3	4	5.2	INFD40	16	INFD40	6
4	5.3	6.8	INFD40	20	INFD40	8
5.5	7.3	9.2	INFD40	25	INFD40	10
7.5	10	12	INFD40	32	INFD40	12
10	13	16	INFD40	32	INFD40	16
11	15	18	INFD40	40	INFD40	20
15	20	23	INFD40	50	INFD40	25
18.5	25	28	INFD40	63	INFD40	32
22	29	33	INFD40	80	INFD40	40
30	40	45	INFD63	100	INFD63	50
37	49	53	INFD63	100	INFD160	63
45	60	64	INFD160	160	INFD160	80
55	73	78	INFD160	160	INFD160	80
75	100	106	INFD200	200	INFD160	125
90	120	130	INFD200	250	INFD160	160
110	147	155	INFD250	315	INFD200	160
132	176	187	INFD250	355	INFD250	200
150	200	211	INFD400	400	INFD400	250
160	213	225	INFD400	400	INFD400	250
200	267	280	INFD400	450	INFD400	315
240	320	338	INFD630	630	INFD630	355
280	373	386	INFD630	800	INFD630	400
300	400	415	INFD630	800	INFD630	450
320	427	435	INFD630	800	INFD630	450
355	473	488	INFD630	800	INFD630	500
375	500	515	-	-	INFD630	500
400	533	552	-	-	INFD630	630
450	600	630	-	-	INFD630	630



## Protection of motor circuits

with DIN fuses

B

525-550 V AC							660-690 V AC						
P(kW)	(HP)	In (A)	Fupact	gG	Fupact	aM	P(kW)	(HP)	In (A)	Fupact	gG	Fupact	aM
0.37	0.49	0.8	INFD40	4	INFD40	2	0.37	0.49	0.7	INFD40	2	INFD40	2
0.55	0.73	1.1	INFD40	4	INFD40	2	0.55	0.73	0.9	INFD40	4	INFD40	2
0.75	1	1.4	INFD40	6	INFD40	2	0.75	1	1.1	INFD40	4	INFD40	2
1.1	1.5	2.1	INFD40	6	INFD40	2	1.1	1.5	1.6	INFD40	6	INFD40	2
1.5	2	2.8	INFD40	10	INFD40	4	1.5	2	2.2	INFD40	6	INFD40	4
2.2	2.9	3.7	INFD40	10	INFD40	4	2.2	2.9	2.8	INFD40	10	INFD40	4
3	4	4.9	INFD40	16	INFD40	6	3	4	3.8	INFD40	10	INFD40	6
4	5.3	6.5	INFD40	20	INFD40	8	4	5.3	4.9	INFD40	16	INFD40	6
5.5	7.3	8.7	INFD40	25	INFD40	10	5.5	7.3	6.7	INFD40	20	INFD40	8
7.5	10	12	INFD40	32	INFD40	12	7.5	10	9	INFD40	25	INFD40	10
10	13	15	INFD40	32	INFD40	16	10	13	12	INFD40	32	INFD40	12
11	15	17	INFD40	40	INFD40	20	11	15	13	INFD40	32	INFD40	16
15	20	22	INFD40	50	INFD40	25	15	20	17	INFD40	40	INFD40	20
18.5	25	27	INFD40	63	INFD40	32	18.5	25	22	INFD40	50	INFD40	25
22	29	31	INFD63	80	INFD40	40	22	29	24	INFD40	50	INFD40	25
30	40	43	INFD160	100	INFD63	50	30	40	32	INFD63	80	INFD40	32
37	49	50	INFD160	100	INFD63	63	37	49	39	INFD63	80	INFD63	40
45	60	61	INFD160	125	INFD63	63	45	60	47	INFD160	100	INFD63	50
55	73	74	INFD200	160	INFD160	80	55	73	57	INFD160	125	INFD63	63
75	100	101	INFD250	200	INFD160	100	75	100	77	INFD200	160	INFD160	80
90	120	123	INFD400	250	INFD160	125	90	120	93	INFD250	200	INFD160	100
110	147	147	INFD400	250	INFD250	160	110	147	113	INFD250	250	INFD160	125
132	176	178	INFD630	355	INFD250	200	132	176	134	INFD250	250	INFD250	160
150	200	200	INFD630	400	INFD250	200	150	200	152	INFD400	315	INFD250	160
160	213	214	INFD630	400	INFD250	250	160	213	162	INFD400	315	INFD250	160
200	267	266	INFD630	450	INFD400	315	200	267	203	INFD630	400	INFD250	200
240	320	321	-	-	INFD400	355	240	320	244	INFD630	450	INFD250	250
280	373	366	-	-	INFD400	400	280	373	284	INFD630	500	INFD400	315
300	400	394	-	-	INFD400	400	300	400	305	INFD630	500	INFD400	315
320	427	413	-	-	INFD630	450	320	427	325	-	-	INFD630	355
355	473	464	-	-	INFD630	500	355	473	354	-	-	INFD630	355
375	500	490	-	-	INFD630	500	375	500	374	-	-	INFD630	400
							400	533	400	-	-	INFD630	400
							450	600	455	-	-	INFD630	450



## Type 2 coordination (IEC 60947-4-1)

U<sub>e</sub>: 380-415 V AC

## Schneider Electric switch-disconnector fuses and contactors

Performance: U<sub>e</sub> = 380-415 V - "I<sub>q</sub>" 100 kA

Starting

Class 10 A/10

Motors P (kW)	I (A) 380 V	I (A) 415 V	I <sub>e</sub> Max (A)	Switch-fuse <sup>[1]</sup>	Fuse-link type		Contactors <sup>[2]</sup>	Thermal relays	
				Type	gG rating (A)	aM rating (A)	Type	Type	I <sub>rt</sub> h (A)
0.37	1.2	1.1	1.6	INFC32 or INFD40	4	2	LC1-D09	LRD 06	1/1.6
0.55	1.6	1.5	1.6	INFC32 or INFD40	6	2	LC1-D09	LRD 06	1/1.6
0.75	2	1.8	2.5	INFC32 or INFD40	10	4	LC1-D09	LRD 07	1.6/2.5
1.1	2.8	2.6	2.5	INFC32 or INFD40	10	4	LC1-D09	LRD 07	1.6/2.5
1.5	3.7	3.4	4	INFC32 or INFD40	16	4	LC1-D09	LRD 08	2.5/4
2.2	5.3	4.8	6	INFC32 or INFD40	16	6	LC1-D09	LRD 10	4/6
3	7	6.5	8	INFC32 or INFD40	20	8	LC1-D09	LRD 12	5.5/8
4	9	8.2	10	INFC32 or INFD40	25	10	LC1-D12	LRD 14	7/10
5.5	12	11	12	INFC32 or INFD40	32	12	LC1-D12	LRD 16	9/13
7.5	16	14	16	INFC32 or INFD40	40	16	LC1-D18	LRD 21	12/18
10	21	19	24	INFC32 or INFD40	50	25	LC1-D25	LRD 22	16/24
11	23	21	24	INFC32 or INFD40	50	25	LC1-D25	LRD 22	16/24
15	30	28	32	INFC32 or INFD40	-	32	LC1-D32	LRD 32	23/32
18.5	37	34	40	INFC63 or INFD40	63	-			
				INFC50 or INFD40	-	40	LC1-D40A	LRD 340	30/40
22	43	40	50	INFC63 or INFD40	80	-			
				INFC50 or INFD63	-	50	LC1-D50A	LRD 350	37/50
30	59	55	63	INFC63 or INFD63	100	-			
				INFC63 or INFD63	125	63	LC1-D65A	LRD 365	48/65
37	72	66	80	INFC125 or INFD160	160	80	LC1-D80	LRD 3363	63/80
45	85	80	100	INFC125 or INFD160	-	100	LC1-D115	LR9-D53 67	60/100
				INFD200	200	-			
55	105	100	115	INFC125 or INFD160	-	125	LC1-D115	LR9-D53 69	90/150
				INFD200	200	-			
75	140	135	150	INFD160	-	160	LC1-D150	LR9-D53 69	90/150
				INFD200	250	-			
90	170	160	185	INFD200	-	200	LC1-F265	LR9-F53 71	132/220
				INFD250	355	-			
110	210	200	220	INFD250	-	250	LC1-F330	LR9-F53 71	132/220
				INFD400	400	-			
132	250	230	250	INFD250	-	250	LC1-F330	LR9-F73 75	200/330
				INFD400	450	-			
160	300	270	265	INFD400	-	315	LC1-F400	LR9-F73 75	200/330
				INFD630	630	-			
200	380	361	400	INFD400	-	400	LC1-F500	LR9-F73 79	300/500
				INFD630	800	-			
250	460	430	500	INFD630	800	500	LC1-F500	LR9-F73 79	300/500
280	520	475	630	INFD630	800	630	LC1-F630	LR9-F73 81	380/630
300	565	500	630	INFD630	-	630	LC1-F630	LR9-F73 81	380/630
335	610	560	630	INFD630	-	630	LC1-F630	LR9-F73 81	380/630
355	630	590	630	INFD630	-	800	LC1-F630	LR9-F73 81	380/630

[1] INFC for NFC cylindrical ferrule / INFD for NH DIN type fuse-link.

[2] Reversers: replace LC1 with LC2; star-delta starter: replace LC1 with LC3.

## Type 2 coordination (IEC 60947-4-1)

U<sub>e</sub>: 380-415 V AC

## Schneider Electric switch-disconnector fuses and contactors

Performance: U<sub>e</sub> = 380-415 V - "I<sub>q</sub>" 100 kA

Starting

Adjustable class 10 A to 30 <sup>[4]</sup>

Motors P (kW)	I (A) 380 V	I (A) 415 V	I <sub>e</sub> Max (A)	Switch-fuse <sup>[1]</sup>	Fuse-link type		Contactors <sup>[2]</sup>	Thermal relays	
				Type	gG rating (A)	aM rating (A)	Type	Type	I <sub>rt</sub> h (A)
0.37	1.2	1.1	2	INFC32 or INFD40	4	2	LC1-D09	LTM R08	0.4/8 <sup>[3]</sup>
0.55	1.6	1.5	2	INFC32 or INFD40	6	2	LC1-D09	LTM R08	0.4/8 <sup>[3]</sup>
0.75	2	1.8	4	INFC32 or INFD40	10	4	LC1-D09	LTM R08	0.4/8 <sup>[3]</sup>
1.1	2.8	2.6	4	INFC32 or INFD40	10	4	LC1-D09	LTM R08	0.4/8 <sup>[3]</sup>
1.5	3.7	3.4	4	INFC32 or INFD40	16	4	LC1-D09	LTM R08	0.4/8 <sup>[3]</sup>
2.2	5.3	4.8	6	INFC32 or INFD40	16	6	LC1-D09	LTM R08	0.4/8 <sup>[3]</sup>
3	7	6.5	8	INFC32 or INFD40	20	8	LC1-D09	LTM R08	0.4/8 <sup>[3]</sup>
4	9	8.2	10	INFC32 or INFD40	25	10	LC1-D12	LTM R27	1.35/27 <sup>[3]</sup>
5.5	12	11	12	INFC32 or INFD40	32	12	LC1-D18	LTM R27	1.35/27 <sup>[3]</sup>
7.5	16	14	16	INFC32 or INFD40	40	16	LC1-D25	LTM R27	1.35/27 <sup>[3]</sup>
10	21	19	25	INFC32 or INFD40	50	25	LC1-D32	LTM R27	1.35/27 <sup>[3]</sup>
11	23	21	25	INFC32 or INFD40	50	25	LC1-D32	LTM R27	1.35/27 <sup>[3]</sup>
15	30	28	32	INFC32 or INFD40	-	32	LC1-D40A	LTM R100	5/100 <sup>[3]</sup>
				INFC63 or INFD40	80	-			
18.5	37	34	40	INFC50 or INFD40	-	40	LC1-D40A	LTM R100	5/100 <sup>[3]</sup>
				INFC63 or INFD40	80	-			
22	43	40	50	INFC50 or INFD63	-	50	LC1-D50A	LTM R100	5/100 <sup>[3]</sup>
				INFC63 or INFD63	100	-			
30	59	55	63	INFC63 or INFD63	125	63	LC1-D65A	LTM R100	5/100 <sup>[3]</sup>
37	72	66	80	INFC125 or INFD160	160	80	LC1-D80	LTM R100	5/100 <sup>[3]</sup>
45	85	80	80	INFC125 or INFD160	-	100	LC1-D115	LTM R100	5/100 <sup>[3]</sup>
				INFD200	200	-			
55	105	100	115	INFC125 or INFD160	-	125	LC1-D115	LTM R08	On CT
				INFD200	200	-			
75	140	135	150	INFD160	-	160	LC1-D150	LTM R08	On CT
				INFD200	250	-			
90	170	160	185	INFD200	-	200	LC1-D265	LTM R08	On CT
				INFD250	355	-			
110	210	200	225	INFD250	-	250	LC1-F330	LTM R08	On CT
				INFD400	400	-			
132	250	230	250	INFD250	-	250	LC1-F330	LTM R08	On CT
				INFD400	450	-			
160	300	270	315	INFD400	-	315	LC1-F400	LTM R08	On CT
				INFD630	630	-			
200	380	361	400	INFD400	-	400	LC1-F500	LTM R08	On CT
				INFD630	800	-			
250	460	430	500	INFD630	800	500	LC1-F500	LTM R08	On CT
280	520	475	630	INFD630	800	630	LC1-F630	LTM R08	On CT
300	565	500	630	INFD630	-	630	LC1-F630	LTM R08	On CT
335	610	560	630	INFD630	-	630	LC1-F630	LTM R08	On CT
355	630	590	630	INFD630	-	800	LC1-F630	LTM R08	On CT

[1] INFC for NFC cylindrical ferrule / INFD for NH DIN type fuse-link.

[2] Reversers: replace LC1 with LC2; star-delta starter: replace LC1 with LC3.

[3] Currents transformers built-in electronic relays.

[4] For use with overload relay set in class 20 and 30, apply respectively a derating of 20 % and 37 %.

## Type 2 coordination (IEC 60947-4-1)

U<sub>e</sub>: 440 V AC

## Schneider Electric switch-disconnector fuses and contactors

Performance: U<sub>e</sub> = 440 V<sup>[3]</sup> - "Iq" 100 kA

Starting

Class 10 A/10

Motors P (kW)	I (A) 440 V	I <sub>e</sub> Max (A)	Switch-fuse <sup>[1]</sup>	Fuse-link type		Contactors <sup>[2]</sup> Type	Thermal relays	
			Type	gG rating (A)	aM rating (A)		Type	I <sub>rt</sub> h (A)
0.37	1	1.6	INFC32 or INFD40	4	2	LC1-D09	LRD 06	1/1.6
0.55	1.4	1.6	INFC32 or INFD40	6	2	LC1-D09	LRD 06	1/1.6
0.75	1.9	2.5	INFC32 or INFD40	6	2	LC1-D09	LRD 07	1.6/2.5
1.1	2.4	2.5	INFC32 or INFD40	10	4	LC1-D09	LRD 07	1.6/2.5
1.5	3.3	4	INFC32 or INFD40	10	4	LC1-D09	LRD 08	2.5/4
2.2	4.7	6	INFC32 or INFD40	16	6	LC1-D09	LRD 10	4/6
3	6.1	6	INFC32 or INFD40	16	6	LC1-D09	LRD 10	4/6
4	7.9	8	INFC32 or INFD40	20	8	LC1-D09	LRD 12	5.5/8
5.5	10.4	10	INFC32 or INFD40	25	10	LC1-D12	LRD 16	9/13
7.5	14	16	INFC32 or INFD40	40	16	LC1-D18	LRD 21	12/18
11	20	20	INFC32 or INFD40	-	20	LC1-D25	LRD 22	16/24
15	26	32	INFC50 or INFD40	50	-	LC1-D32	LRD 32	23/32
			INFC32 or INFD40	-	32			
18.5	33	40	INFC63 or INFD40	63	-	LC1-D40A	LRD 340	30/40
			INFC50 or INFD40	-	40			
22	39	50	INFC63 or INFD40	80	-	LC1-D50A	LRD 340	30/40
			INFC50 or INFD63	-	50			
30	52	63	INFC63 or INFD63	100	-	LC1-D65A	LRD 365	48/65
			INFC50 or INFD63	-	63			
37	65	65	INFC63 or INFD63	125	-	LC1-D80	LRD 3359	48/65
			INFC125 or INFD160	-	80			
45	75	80	INFD160	160	-	LC1-D80	LRD 3363	63/80
			INFC125 or INFD160	-	80			
55	92	100	INFD160	160	-	LC1-D115	LR9-D53 67	60/100
			INFC125 or INFD160	-	100			
75	128	125	INFD160	200	-	LC1-D150	LR9-D53 69	90/150
			INFD200	250	-			
90	155	150	INFD160	-	160	LC1-D185	LR9-D53 69	90/150
			INFD250	315	-			
110	185	200	INFD200	-	200	LC1-F265	LR9-F53 71	132/220
			INFD250	355	-			
132	213	220	INFD250	-	250	LC1-F265	LR9-F53 71	132/220
			INFD400	400	-			
160	259	315	INFD400	500	315	LC1-F330	LR9-F73 75	200/330
200	338	330	INFD400	-	355	LC1-F400	LR9-F73 75	200/330
			INFD630	630	-			
250	423	400	INFD630	800	400	LC1-F500	LR9-F73 79	300/500
280	460	450	INFD630	800	450	LC1-F500	LR9-F73 79	300/500
300	495	500	INFD630	800	500	LC1-F500	LR9-F73 79	300/500
355	560	630	INFD630	-	630	LC1-F630	LR9-F73 81	380/630
375	575	630	INFD630	-	630	LC1-F630	LR9-F73 81	380/630
400	611	630	INFD630	-	800	LC1-F630	LR9-F73 81	380/630

[1] INFC for NFC cylindrical ferrule / INFD for NH DIN type fuse-link.

[2] Reversers: replace LC1 with LC2; star-delta starter: replace LC1 with LC3.

[3] Valid for 480V NEMA network.

## Type 2 coordination (IEC 60947-4-1)

U<sub>e</sub>: 440 V AC

## Schneider Electric switch-disconnector fuses and contactors

Performance: U<sub>e</sub> = 440 V <sup>[5]</sup> - "I<sub>q</sub>" 100 kA

Starting

Adjustable class 10 A to 30 <sup>[4]</sup>

Motors			Switch-fuse <sup>[1]</sup>	Fuse-link type		Contactors <sup>[2]</sup>	Thermal relays	
P (kW)	I (A) 440 V	I <sub>e</sub> Max (A)		Type	gG rating (A)		aM rating (A)	Type
0.37	1	2	INFC32 or INFD40	4	2	LC1-D09	LTM R08	0.4/8 <sup>[3]</sup>
0.55	1.4	2	INFC32 or INFD40	6	2	LC1-D09	LTM R08	0.4/8 <sup>[3]</sup>
0.75	1.8	2	INFC32 or INFD40	6	2	LC1-D09	LTM R08	0.4/8 <sup>[3]</sup>
1.1	2.4	4	INFC32 or INFD40	10	4	LC1-D09	LTM R08	0.4/8 <sup>[3]</sup>
1.5	3.3	4	INFC32 or INFD40	10	4	LC1-D09	LTM R08	0.4/8 <sup>[3]</sup>
2.2	4.7	6	INFC32 or INFD40	16	6	LC1-D09	LTM R08	0.4/8 <sup>[3]</sup>
3	6.1	6	INFC32 or INFD40	16	6	LC1-D09	LTM R08	0.4/8 <sup>[3]</sup>
4	7.9	8	INFC32 or INFD40	20	8	LC1-D09	LTM R08	0.4/8 <sup>[3]</sup>
5.5	10.4	10	INFC32 or INFD40	25	10	LC1-D12	LTM R27	1.35/27 <sup>[3]</sup>
7.5	14	16	INFC32 or INFD40	40	16	LC1-D18	LTM R27	1.35/27 <sup>[3]</sup>
11	20	20	INFC32 or INFD40	-	20	LC1-D25	LTM R27	1.35/27 <sup>[3]</sup>
15	26	27	INFC50 or INFD40	50	-	-	-	-
			INFC32 or INFD40	-	32	LC1-D32	LTM R27	1.35/27 <sup>[3]</sup>
18.5	33	40	INFC63 or INFD40	63	-	-	-	-
			INFC50 or INFD40	-	40	LC1-D40A	LTM R100	5/100 <sup>[3]</sup>
22	39	50	INFC63 or INFD40	80	-	-	-	-
			INFC50 or INFD63	-	50	LC1-D50A	LTM R100	5/100 <sup>[3]</sup>
30	52	63	INFC63 or INFD63	100	-	-	-	-
			INFC50 or INFD63	-	63	LC1-D63A	LTM R100	5/100 <sup>[3]</sup>
37	65	80	INFC63 or INFD63	125	-	-	-	-
			INFC125 or INFD160	-	80	LC1-D80	LTM R100	5/100 <sup>[3]</sup>
45	75	80	INFD160	160	-	-	-	-
			INFC125 or INFD160	-	80	LC1-D80	LTM R100	5/100 <sup>[3]</sup>
55	92	100	INFD160	160	-	-	-	-
			INFC125 or INFD160	-	100	LC1-D115	LTM R100	5/100 <sup>[3]</sup>
75	128	125	INFD160	200	-	-	-	-
			INFD200	250	-	125	LC1-D150	LTM R08
90	155	160	INFD160	-	160	LC1-F185	LTM R08	On CT
			INFD250	315	-	-	-	-
110	185	200	INFD200	-	200	LC1-F265	LTM R08	On CT
			INFD250	355	-	-	-	-
132	213	250	INFD250	-	250	LC1-F265	LTM R08	On CT
			INFD400	400	-	-	-	-
160	259	315	INFD400	500	315	LC1-F330	LTM R08	On CT
200	338	355	INFD400	-	355	LC1-F400	LTM R08	On CT
			INFD630	630	-	-	-	-
250	423	400	INFD630	800	400	LC1-F500	LTM R08	On CT
280	460	450	INFD630	800	450	LC1-F500	LTM R08	On CT
300	495	500	INFD630	800	500	LC1-F500	LTM R08	On CT
355	560	630	INFD630	-	630	LC1-F630	LTM R08	On CT
375	575	630	INFD630	-	630	LC1-F630	LTM R08	On CT
400	611	630	INFD630	-	800	LC1-F630	LTM R08	On CT

[1] INFC for NFC cylindrical ferrule / INFD for NH DIN type fuse-link.

[2] Reversers: replace LC1 with LC2; star-delta starter: replace LC1 with LC3.

[3] Currents transformers built-in electronic relays.

[4] For use with overload relay setted in class 20 and 30, apply respectively a derating of 20 % and 37 %.

[5] Valid for 480 V NEMA network.

## Type 2 coordination (IEC 60947-4-1)

U<sub>e</sub>: 500 V AC

## Schneider Electric switch-disconnector fuses and contactors

Performance: U<sub>e</sub> = 500 V - "I<sub>q</sub>" 100 kA

Starting

Class 10 A/10

Motors			Switch-fuse <sup>[1]</sup>	Fuse-link type		Contactors <sup>[2]</sup>	Thermal relays	
P (kW)	I (A) 500 V	I <sub>e</sub> Max (A)		Type	gG rating (A)		aM rating (A)	Type
0.37	0.8	1	INFC32 or INFD40	4	2	LC1-D09	LRD 05	0.63/1
0.55	1.2	1.6	INFC32 or INFD40	4	2	LC1-D09	LRD 06	1/1.6
0.75	1.5	1.6	INFC32 or INFD40	6	2	LC1-D09	LRD 06	1/1.6
1.1	2	2	INFC32 or INFD40	6	2	LC1-D09	LRD 07	1.6/2.5
1.5	2.8	4	INFC32 or INFD40	10	4	LC1-D09	LRD 08	2.5/4
2.2	3.8	4	INFC32 or INFD40	10	4	LC1-D09	LRD 08	2.5/4
3	5	6	INFC32 or INFD40	16	6	LC1-D09	LRD 10	4/6
4	6.5	8	INFC32 or INFD40	20	8	LC1-D09	LRD 12	5.5/8
5.5	9	10	INFC32 or INFD40	25	10	LC1-D12	LRD 16	9/13
7.5	12	12	INFC32 or INFD40	32	12	LC1-D18	LRD 16	9/13
10	15	16	INFC32 or INFD40	32	16	LC1-D25	LRD 21	12/18
11	18.4	20	INFC32 or INFD40	40	20	LC1-D25	LRD 22	16/24
15	23	24	INFC32 or INFD40	-	25	LC1-D32	LRD 22	16/24
			INFC63 or INFD40	50	-			
18.5	28.5	32	INFC50 or INFD40	-	32	LC1-D32	LRD 32	23/32
			INFC63 or INFD40	63	-			
22	33	40	INFC50 or INFD40	-	40	LC1-D40A	LRD 340	30/40
			INFC63 or INFD40	80	-			
30	45	50	INFC63 or INFD63	100	50	LC1-D50A	LRD 350	37/50
37	55	63	INFC63 or INFD63	100	63	LC1-D65A	LRD 365	48/65
45	65	70	INFC125 or INFD160	-	80	LC1-D80	LRD 3361	55/70
			INFD160	160	-			
55	75	80	INFC125 or INFD160	-	80	LC1-D115	LRD 3363	63/80
			INFD160	160	-			
75	105	115	INFD160	-	125	LC1-D115	LR9-D53 69	90/150
			INFD200	200	-			
90	130	150	INFD160		160	LC1-D150	LR9-D53 69	90/150
			INFD200	250				
110	156	160	INFD200	-	160	LC1-F185	LR9-F53 71	132/220
			INFD250	315	-			
132	187	200	INFD250	355	200	LC1-F265	LR9-F53 71	132/220
160	230	250	INFD400	400	250	LC1-F265	LR9-F73 75	200/330
200	280	315	INFD400	450	315	LC1-F400	LR9-F73 75	200/330
240	338	355	INFD630	630	355	LC1-F400	LR9-F73 79	300/500
280	386	400	INFD630	800	400	LC1-F500	LR9-F73 79	300/500
300	415	450	INFD630	800	450	LC1-F500	LR9-F73 79	300/500
320	425	450	INFD630	800	450	LC1-F500	LR9-F73 79	300/500
355	478	500	INFD630	800	500	LC1-F500	LR9-F73 79	300/500
375	482	500	INFD630	-	500	LC1-F630	LR9-F73 81	380/630
400	534	500	INFD630	-	630	LC1-F630	LR9-F73 81	380/630
450	630	630	INFD630	-	630	LC1-F630	LR9-F73 81	380/630

[1] INFC for NFC cylindrical ferrule / INFD for NH DIN type fuse-link.

[2] Reversers: replace LC1 with LC2 ; start-delta starter: replace LC1 with LC3.

Note: proposed fuses are based on 4 poles 50 Hz induction motors direct on line start I<sub>d</sub>/I<sub>n</sub> y 7 for 10 sec. The choice of fuses and overload relay shall be checked according to the actual motor's characteristic.

## Type 2 coordination (IEC 60947-4-1) 500 V

U<sub>e</sub>: 500 V AC

## Schneider Electric switch-disconnector fuses and contactors

Performance: U<sub>e</sub> = 500 V - "Iq" 100 kA

Starting

Adjustable class 10 A to 30 <sup>[4]</sup>

Motors P (kW)	I (A) 500 V	I <sub>e</sub> Max (A)	Switch-fuse <sup>[1]</sup>	Fuse-link type		Contactors <sup>[2]</sup>	Thermal relays	
			Type	gG rating (A)	aM rating (A)	Type	Type	I <sub>rth</sub> (A)
0.37	0.8	1	INFC32 or INFD40	4	2	LC1-D09	LTM R08	0.4/8 <sup>[3]</sup>
0.55	1.2	1.6	INFC32 or INFD40	4	2	LC1-D09	LTM R08	0.4/8 <sup>[3]</sup>
0.75	1.5	1.6	INFC32 or INFD40	6	2	LC1-D09	LTM R08	0.4/8 <sup>[3]</sup>
1.1	2	2	INFC32 or INFD40	6	2	LC1-D09	LTM R08	0.4/8 <sup>[3]</sup>
1.5	2.8	4	INFC32 or INFD40	10	4	LC1-D09	LTM R08	0.4/8 <sup>[3]</sup>
2.2	3.8	4	INFC32 or INFD40	10	4	LC1-D09	LTM R08	0.4/8 <sup>[3]</sup>
3	5	6	INFC32 or INFD40	16	6	LC1-D09	LTM R08	0.4/8 <sup>[3]</sup>
4	6.5	8	INFC32 or INFD40	20	8	LC1-D09	LTM R08	0.4/8 <sup>[3]</sup>
5.5	9	10	INFC32 or INFD40	25	10	LC1-D25	LTM R27	1.35/27 <sup>[3]</sup>
7.5	12	12	INFC32 or INFD40	32	12	LC1-D25	LTM R27	1.35/27 <sup>[3]</sup>
10	15	16	INFC32 or INFD40	32	16	LC1-D25	LTM R27	1.35/27 <sup>[3]</sup>
11	18.4	20	INFC32 or INFD40	40	20	LC1-D25	LTM R27	1.35/27 <sup>[3]</sup>
15	23	24	INFC32 or INFD40	-	25	LC1-D32	LTM R27	1.35/27 <sup>[3]</sup>
18.5	28.5	32	INFC63 or INFD40	50	-			
			INFC50 or INFD40	-	32	LC1-D32	LTM R100	5/100 <sup>[3]</sup>
22	33	40	INFC63 or INFD40	63	-			
			INFC50 or INFD40	-	40	LC1-D40A	LTM R100	5/100 <sup>[3]</sup>
30	45	50	INFC63 or INFD40	80	-			
			INFC63 or INFD63	100	50	LC1-D50A	LTM R100	5/100 <sup>[3]</sup>
37	55	63	INFC63 or INFD63	100	63	LC1-D65A	LTM R100	5/100 <sup>[3]</sup>
45	65	70	INFC125 or INFD160	-	80	LC1-D80	LTM R100	5/100 <sup>[3]</sup>
			INFD160	160	-			
55	75	80	INFC125 or INFD160	-	80	LC1-D115	LTM R100	5/100 <sup>[3]</sup>
			INFD160	160	-			
75	105	115	INFD160	-	125	LC1-D115	LTM R08	On CT
			INFD200	200	-			
90	130	150	INFD160	-	160	LC1-D150	LTM R08	On CT
			INFD200	250	-			
110	156	160	INFD200	-	160	LC1-F185	LTM R08	On CT
			INFD250	315	-			
132	187	200	INFD250	355	200	LC1-F265	LTM R08	On CT
160	230	250	INFD400	400	250	LC1-F265	LTM R08	On CT
200	280	315	INFD400	450	315	LC1-F400	LTM R08	On CT
240	338	355	INFD630	630	355	LC1-F400	LTM R08	On CT
280	386	400	INFD630	800	400	LC1-F500	LTM R08	On CT
300	415	450	INFD630	800	450	LC1-F500	LTM R08	On CT
320	425	450	INFD630	800	450	LC1-F500	LTM R08	On CT
355	478	500	INFD630	800	500	LC1-F500	LTM R08	On CT
375	482	500	INFD630	-	500	LC1-F630	LTM R08	On CT
400	534	500	INFD630	-	630	LC1-F630	LTM R08	On CT
450	630	630	INFD630	-	630	LC1-F630	LTM R08	On CT

[1] INFC for NFC cylindric ferrule / INFD for NH DIN type fuse-link.

[2] Reversers: replace LC1 with LC2; star-delta starter: replace LC1 with LC3.

[3] Currents transformers built-in electronic relays.

[4] For use with overload relay setted in class 20 and 30, apply respectively a derating of 20 % and 37 %.

## Type 2 coordination (IEC 60947-4-1)

U<sub>e</sub>: 525-550 V AC

## Schneider Electric switch-disconnector fuses and contactors

Performance: U<sub>e</sub> = 525-550 V - "I<sub>q</sub>" 80/100 kA<sup>[1]</sup>

Starting

Class 10 A/10

Motors				Switch-fuse <sup>[1]</sup>	Fuse-link type		Contactors <sup>[2]</sup>	Thermal relays	
P (kW)	I (A) 525 V	I (A) 550 V	I <sub>e</sub> Max (A)		Type	gG rating (A)		aM rating (A)	Type
0.37	0.8	0.8	1	INFC32 or INFD40	-	2	LC1-D09	LRD 05	0.63/1
				INFC63 or INFD40	4	-			
0.55	1.2	1.1	1.6	INFC32 or INFD40	-	2	LC1-D09	LRD 06	1/1.6
				INFC63 or INFD40	4	-			
0.75	1.5	1.4	1.6	INFC32 or INFD40	-	2	LC1-D09	LRD 06	1/1.6
				INFC63 or INFD40	6	-			
1.1	2	2.1	2.5	INFC32 or INFD40	-	2	LC1-D09	LRD 07	1.6/2.5
				INFC63 or INFD40	6	-			
1.5	2.8	2.8	4	INFC32 or INFD40	-	4	LC1-D09	LRD 08	2.5/4
				INFC63 or INFD40	10	-			
2.2	3.8	3.7	4	INFC32 or INFD40	-	4	LC1-D09	LRD 08	2.5/4
				INFC63 or INFD40	10	-			
3	5	4.9	6	INFC32 or INFD40	-	6	LC1-D09	LRD 10	4/6
				INFC63 or INFD40	16	-			
4	6.5	6.5	8	INFC32 or INFD40	-	8	LC1-D09	LRD 12	5.5/8
				INFC63 or INFD40	20	-			
5.5	9	8.7	10	INFC32 or INFD40	-	10	LC1-D25	LRD 16	9/13
				INFC63 or INFD40	25	-			
7.5	12	11.8	12	INFC32 or INFD40	-	12	LC1-D25	LRD 16	9/13
				INFC63 or INFD40	32	-			
10	15	15.2	16	INFC32 or INFD40	-	16	LC1-D25	LRD 21	12/18
				INFC63 or INFD40	32	-			
11	18.4	16.7	24	INFC32 or INFD40	-	20	LC1-D25	LRD 22	16/24
				INFC63 or INFD40	40	-			
15	23	21.9	24	INFC32 or INFD40	-	25	LC1-D32	LRD 22	16/24
				INFC63 or INFD40	50	-			
18.5	28.5	26.6	32	INFC63 or INFD40	63	32	LC1-D32	LRD 32	23/32
22	33	31	40	INFC63 or INFD40	-	40	LC1-D40A	LRD 340	30/40
				INFC63 or INFD63	80	-			
30	45	43	50	INFC63 or INFD63	-	50	LC1-D50A	LRD 350	37/50
				INFD160	100	-			
37	55	50	63	INFC63 or INFD63	-	63	LC1-D65A	LRD 365	48/65
				INFD160	100	-			
45	65	61	70	INFC63 or INFD63	-	63	LC1-D80	LRD 3361	55/70
				INFD160	125	-			
55	75	74	80	INFC63 or INFD160	-	80	LC1-D115	LRD 3363	63/80
				INFD200	160	-			
75	105	101	115	INFD160	-	100	LC1-D115	LR9-D53 69	90/150
				INFD250	200	-			
90	130	123	125	INFD160	-	125	LC1-D150	LR9-D53 69	90/150
				INFD400	250	-			
110	156	147	160	INFD250	-	160	LC1-F185	LR9-F53 71	132/220
				INFD400	250	-			
132	187	178	200	INFD250	-	200	LC1-F265	LR9-F53 71	132/220
				INFD630	355	-			
160	214	204	250	INFD250	-	250	LC1-F265	LR9-F73 75	200/330
				INFD630	400	-			
200	266	254	315	INFD400	-	315	LC1-F400	LR9-F73 75	200/330
				INFD630	450	-			
240	321	307	355	INFD400	-	355	LC1-F400	LR9-F73 79	300/500
280	366	350	400	INFD400	-	400	LC1-F500	LR9-F73 79	300/500
300	394	376	400	INFD400	-	400	LC1-F500	LR9-F73 79	300/500
320	413	394	450	INFD630	-	450	LC1-F500	LR9-F73 79	300/500
355	464	443	500	INFD630	-	500	LC1-F500	LR9-F73 79	300/500
375	490	467	500	INFD630	-	500	LC1-F630	LR9-F73 81	380/630

[1] Coordination chart built with 690 V fuse-links (80 kA for NFC fuse-links, 100 kA for DIN fuse-link).

[2] INFC for NFC cylindrical ferrule / INFD for NH DIN type fuse-link.

[3] Reversers: replace LC1 with LC2; star-delta starter: replace LC1 with LC3.

## Type 2 coordination (IEC 60947-4-1)

U<sub>e</sub>: 525-550 V

## Schneider Electric switch-disconnector fuses and contactors

Performance: U<sub>e</sub> = 525-550 V - "Iq" 80/100 kA<sup>[1]</sup>

Starting

Adjustable class 10 A to 30<sup>[4]</sup>

Motors P (kW)	I (A) 525 V	I (A) 550 V	I <sub>e</sub> Max (A)	Switch-fuse <sup>[1]</sup>	Fuse-link type		Contactors <sup>[2]</sup>	Thermal relays	
				Type	gG rating (A)	aM rating (A)	Type	Type	I <sub>rt</sub> h (A)
0.37	0.8	0.8	2	INFC32 or INFD40	-	2	LC1-D09	LTM R08	0.4/8 <sup>[5]</sup>
				INFC63 or INFD40	4	-			
0.55	1.2	1.1	2	INFC32 or INFD40	-	2	LC1-D09	LTM R08	0.4/8 <sup>[5]</sup>
				INFC63 or INFD40	4	-			
0.75	1.5	1.4	2	INFC32 or INFD40	-	2	LC1-D09	LTM R08	0.4/8 <sup>[5]</sup>
				INFC63 or INFD40	6	-			
1.1	2	2.1	2	INFC32 or INFD40	-	2	LC1-D09	LTM R08	0.4/8 <sup>[5]</sup>
				INFC63 or INFD40	6	-			
1.5	2.8	2.8	4	INFC32 or INFD40	-	4	LC1-D09	LTM R08	0.4/8 <sup>[5]</sup>
				INFC63 or INFD40	10	-			
2.2	3.8	3.7	4	INFC32 or INFD40	-	4	LC1-D09	LTM R08	0.4/8 <sup>[5]</sup>
				INFC63 or INFD40	10	-			
3	5	4.9	6	INFC32 or INFD40	-	6	LC1-D09	LTM R08	0.4/8 <sup>[5]</sup>
				INFC63 or INFD40	16	-			
4	6.5	6.5	8	INFC32 or INFD40	-	8	LC1-D09	LTM R08	0.4/8 <sup>[5]</sup>
				INFC63 or INFD40	20	-			
5.5	9	8.7	10	INFC32 or INFD40	-	10	LC1-D25	LTM R27	1.35/27 <sup>[5]</sup>
				INFC63 or INFD40	25	-			
7.5	12	11.8	12	INFC32 or INFD40	-	12	LC1-D25	LTM R27	1.35/27 <sup>[5]</sup>
				INFC63 or INFD40	32	-			
10	15	15.2	16	INFC32 or INFD40	-	16	LC1-D25	LTM R27	1.35/27 <sup>[5]</sup>
				INFC63 or INFD40	32	-			
11	18.4	16.7	20	INFC32 or INFD40	-	20	LC1-D25	LTM R27	1.35/27 <sup>[5]</sup>
				INFC63 or INFD40	40	-			
15	23	21.9	25	INFC32 or INFD40	-	25	LC1-D32	LTM R27	1.35/27 <sup>[5]</sup>
				INFC63 or INFD40	50	-			
18.5	28.5	26.6	32	INFC63 or INFD40	63	32	LC1-D32	LTM R100	5/100 <sup>[5]</sup>
				INFC63 or INFD40	-	40			
22	33	31	40	INFC63 or INFD63	80	-	LC1-D40A	LTM R100	5/100 <sup>[5]</sup>
				INFC63 or INFD63	-	50			
30	45	43	50	INFC63 or INFD63	-	50	LC1-D50A	LTM R100	5/100 <sup>[5]</sup>
				INFD160	100	-			
37	55	50	63	INFC63 or INFD63	-	63	LC1-D65A	LTM R100	5/100 <sup>[5]</sup>
				INFD160	100	-			
45	65	61	63	INFC63 or INFD63	-	63	LC1-D80	LTM R100	5/100 <sup>[5]</sup>
				INFD160	125	-			
55	75	74	80	INFC63 or INFD160	-	80	LC1-D115	LTM R100	5/100 <sup>[5]</sup>
				INFD200	160	-			
75	105	101	100	INFD160	-	100	LC1-D115	LTM R08	On CT
				INFD250	200	-			
90	130	123	125	INFD160	-	125	LC1-D150	LTM R08	On CT
				INFD400	250	-			
110	156	147	160	INFD250	-	160	LC1-F185	LTM R08	On CT
				INFD400	250	-			
132	187	178	200	INFD250	-	200	LC1-F265	LTM R08	On CT
				INFD630	355	-			
160	214	204	250	INFD250	-	250	LC1-F265	LTM R08	On CT
				INFD630	400	-			
200	266	254	315	INFD400	-	315	LC1-F400	LTM R08	On CT
				INFD630	450	-			
240	321	307	355	INFD400	-	355	LC1-F400	LTM R08	On CT
280	366	350	400	INFD400	-	400	LC1-F500	LTM R08	On CT
300	394	376	400	INFD400	-	400	LC1-F500	LTM R08	On CT
320	413	394	450	INFD630	-	450	LC1-F500	LTM R08	On CT
355	464	443	500	INFD630	-	500	LC1-F500	LTM R08	On CT
375	490	467	500	INFD630	-	500	LC1-F630	LTM R08	On CT

[1] Coordination chart built with 690 V fuse-links (80 kA for NFC fuse-links, 100 kA for DIN fuse-link).

[2] INFC for NFC cylindrical ferrule / INFD for NH DIN type fuse-link.

[3] Reversers: replace LC1 with LC2; star-delta starter: replace LC1 with LC3.

[4] For use with overload relay set in class 20 and 30, apply respectively a derating of 20 % and 37 %.

[5] Currents transformers built-in electronic relays.



## Type 2 coordination (IEC 60947-4-1)

U<sub>e</sub>: 660-690 V

## Schneider Electric switch-disconnector fuses and contactors

Performance: U<sub>e</sub> = 660-690 V - "Iq" 80/100 kA<sup>[1]</sup>

Starting

Class 10 A/10

Motors P (kW)	I (A) 690 V	I <sub>e</sub> Max (A)	Switch-fuse <sup>[1]</sup>	Fuse-link type		Contactors <sup>[2]</sup>	Thermal relays	
			Type	gG rating (A)	aM rating (A)	Type	Type	I <sub>rt</sub> h (A)
0.75	1.1	1.6	INFC32 or INFD40	-	2	LC1-D09	LRD 06	1/1.6
			INFC63 or INFD40	4	-			
1	1.6	1.6	INFC32 or INFD40	-	2	LC1-D09	LRD 06	1/1.6
			INFC63 or INFD40	6	-			
1.5	2.2	2.5	INFC32 or INFD40	-	4	LC1-D09	LRD 07	1.6/2.5
			INFC63 or INFD40	6	-			
2.2	2.8	4	INFC32 or INFD40	-	4	LC1-D09	LRD 08	2.5/4
			INFC63 or INFD40	10	-			
3	3.8	4	INFC32 or INFD40	-	6	LC1-D09	LRD 08	2.5/4
			INFC63 or INFD40	10	-			
4	4.9	6	INFC32 or INFD40	-	6	LC1-D09	LRD 10	4/6
			INFC63 or INFD40	16	-			
5.5	6.7	8	INFC32 or INFD40	-	8	LC1-D09	LRD 12	5.5/8
			INFC63 or INFD40	20	-			
7.5	8.9	10	INFC32 or INFD40	-	10	LC1-D25	LRD 16	9/13
			INFC63 or INFD40	25	-			
11	12.8	13	INFC32 or INFD40	-	16	LC1-D25	LRD 16	9/13
			INFC63 or INFD40	32	-			
15	17	20	INFC32 or INFD40	-	20	LC1-D25	LRD 22	16/24
			INFC63 or INFD40	40	-			
18.5	22	24	INFC32 or INFD40	-	25	LC1-D32	LRD 22	16/24
			INFC63 or INFD40	50	-			
22	24	32	INFC32 or INFD40	-	25	LC1-D40A	LRD 332	23/32
			INFC63 or INFD40	50	-			
30	32	32	INFC63 or INFD40	-	32	LC1-D40A	LRD 340	30/40
			INFC63 or INFD63	80	-			
37	39	40	INFC63 or INFD63	80	40	LC1-D65A	LRD 365	37/50
			INFC63 or INFD63	-	50			
45	47	50	INFD160	100	-	LC1-D80	LRD 3357	37/50
			INFC63 or INFD63	-	63			
55	57	63	INFC63 or INFD63	-	63	LC1-D115	LRD 3359	48/65
			INFD160	125	-			
75	77	80	INFC125 or INFD160	-	80	LC1-D115	LRD 3363	63/80
			INFD200	160	-			
90	93	100	INFD160	-	100	LC1-D150	LR9-D53 69	90/150
			INFD250	200	-			
110	113	125	INFD160	-	125	LC1-F185	LR9-D53 69	90/150
			INFD250	250	-			
132	134	160	INFD250	250	160	LC1-F265	LR9-F53 71	132/220
			INFD250	-	160			
160	162	160	INFD400	315	-	LC1-F265	LR9-F53 71	132/220
			INFD250	-	200			
200	203	200	INFD250	-	200	LC1-F400	LR9-F73 75	200/330
			INFD630	400	-			
220	223	250	INFD250	-	250	LC1-F400	LR9-F73 75	200/330
			INFD630	450	-			
250	253	315	INFD400	-	315	LC1-F400	LR9-F73 75	200/330
			INFD630	500	-			
315	320	355	INFD630	-	355	LC1-F500	LR9-F73 79	300/500
355	354	400	INFD630	-	400	LC1-F630	LR9-F73 79	300/500
400	400	450	INFD630	-	450	LC1-F630	LR9-F73 79	300/500
450	455	500	INFD630	-	500	LC1-F630	LR9-F73 79	300/500

[1] Coordination chart built with 690 V fuse-links (80 kA for NFC fuse-links, 100 kA for DIN fuse-link).

[2] INFC for NFC cylindrical ferrule / INFD for NH DIN type fuse-link.

[3] Reversers: replace LC1 with LC2; star-delta starter: replace LC1 with LC3.

## Type 2 coordination (IEC 60947-4-1)

U<sub>e</sub>: 660-690 V

## Schneider Electric switch-disconnector fuses and contactors

Performance: U<sub>e</sub> = 660-690 V - "Iq" 80/100 kA<sup>[1]</sup>

Starting

Adjustable class 10 A to 30<sup>[4]</sup>

Motors P (kW)	I (A) 690 V	I <sub>e</sub> Max (A)	Switch-fuse <sup>[1]</sup>	Fuse-link type		Contactors <sup>[2]</sup>	Thermal relays	
			Type	gG rating (A)	aM rating (A)	Type	Type	I <sub>rt</sub> h (A)
0.75	1.1	2	INFC32 or INFD40	-	2	LC1-D09	LTM R08	0.4/8 <sup>[5]</sup>
			INFC63 or INFD40	4	-			
1	1.6	2	INFC32 or INFD40	-	2	LC1-D09	LTM R08	0.4/8 <sup>[5]</sup>
			INFC63 or INFD40	6	-			
1.5	2.2	4	INFC32 or INFD40	-	4	LC1-D09	LTM R08	0.4/8 <sup>[5]</sup>
			INFC63 or INFD40	6	-			
2.2	2.8	4	INFC32 or INFD40	-	4	LC1-D09	LTM R08	0.4/8 <sup>[5]</sup>
			INFC63 or INFD40	10	-			
3	3.8	6	INFC32 or INFD40	-	6	LC1-D09	LTM R08	0.4/8 <sup>[5]</sup>
			INFC63 or INFD40	10	-			
4	4.9	6	INFC32 or INFD40	-	6	LC1-D09	LTM R08	0.4/8 <sup>[5]</sup>
			INFC63 or INFD40	16	-			
5.5	6.7	8	INFC32 or INFD40	-	8	LC1-D09	LTM R08	0.4/8 <sup>[5]</sup>
			INFC63 or INFD40	20	-			
7.5	8.9	10	INFC32 or INFD40	-	10	LC1-D25	LTM R27	1.35/27 <sup>[5]</sup>
			INFC63 or INFD40	25	-			
11	12.8	16	INFC32 or INFD40	-	16	LC1-D25	LTM R27	1.35/27 <sup>[5]</sup>
			INFC63 or INFD40	32	-			
15	17	20	INFC32 or INFD40	-	20	LC1-D25	LTM R27	1.35/27 <sup>[5]</sup>
			INFC63 or INFD40	40	-			
18.5	22	25	INFC32 or INFD40	-	25	LC1-D32	LTM R27	1.35/27 <sup>[5]</sup>
			INFC63 or INFD40	50	-			
22	24	25	INFC32 or INFD40	-	25	LC1-D40A	LTM R27	1.35/27 <sup>[5]</sup>
			INFC63 or INFD40	50	-			
30	32	32	INFC63 or INFD40	-	32	LC1-D40A	LTM R100	5/100 <sup>[5]</sup>
			INFC63 or INFD63	80	-			
37	39	40	INFC63 or INFD63	80	40	LC1-D65A	LTM R100	5/100 <sup>[5]</sup>
45	47	50	INFC63 or INFD63	-	50	LC1-D80	LTM R100	5/100 <sup>[5]</sup>
			INFD160	100	-			
55	57	63	INFC63 or INFD63	-	63	LC1-D115	LTM R100	5/100 <sup>[5]</sup>
			INFD160	125	-			
75	77	80	INFC125 or INFD160	-	80	LC1-D115	LTM R100	5/100 <sup>[5]</sup>
			INFD200	160	-			
90	93	100	INFD160	-	100	LC1-D150	LTM R100	5/100 <sup>[5]</sup>
			INFD250	200	-			
110	113	125	INFD160	-	125	LC1-F185	LTM R08	On CT
			INFD250	250	-			
132	134	160	INFD200	-	160	LC1-F265	LTM R08	On CT
			INFD250	250	-			
160	162	160	INFD200	-	160	LC1-F265	LTM R08	On CT
			INFD400	315	-			
200	203	200	INFD200	-	200	LC1-F400	LTM R08	On CT
			INFD630	400	-			
220	223	250	INFD250	-	250	LC1-F400	LTM R08	On CT
			INFD630	450	-			
250	253	315	INFD400	-	315	LC1-F400	LTM R08	On CT
			INFD630	500	-			
315	320	355	INFD400	-	355	LC1-F500	LTM R08	On CT
355	354	400	INFD400	-	400	LC1-F630	LTM R08	On CT
400	400	450	INFD630	-	450	LC1-F630	LTM R08	On CT
450	455	500	INFD630	-	500	LC1-F630	LTM R08	On CT

[1] Coordination chart built with 690 V fuse-links (80 kA for NFC fuse-links, 100 kA for DIN fuse-link).

[2] INFC for NFC cylindrical ferrule / INFD for NH DIN type fuse-link.

[3] Reversers: replace LC1 with LC2; star-delta starter: replace LC1 with LC3.

[4] For use with overload relay set in class 20 and 30, apply respectively a derating of 20 % and 37 %.

[5] Currents transformers built-in electronic relays.

# Use of LV switches

## Presentation

### Functions performed by switch

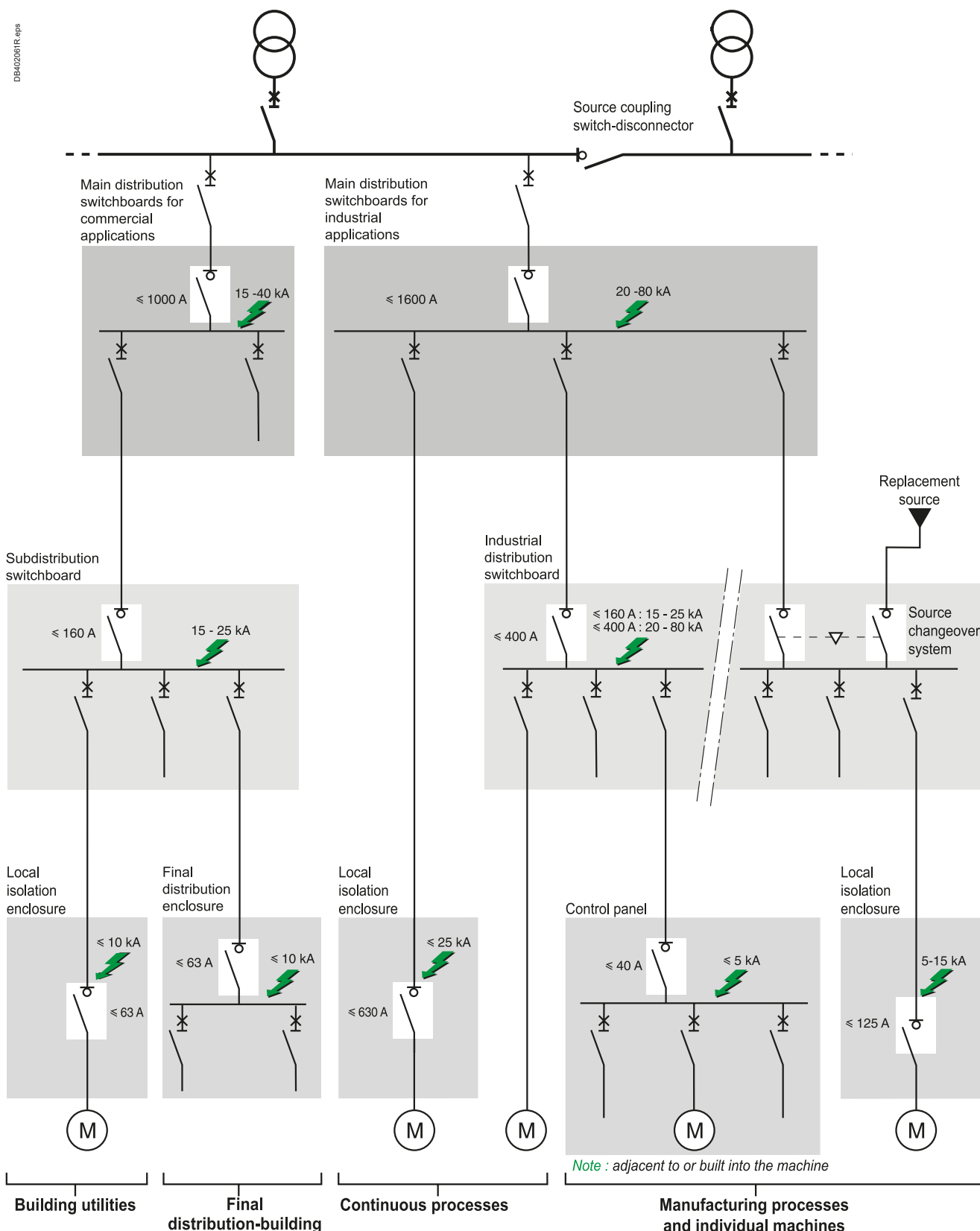

# Use of LV switches

## Presentation

### Functions and positions of LV switches

Switches are necessary in different level of low voltage installation for the following main applications :

- functional switching
- supplying installation from different sources (transfert-switching equipment)
- starting stopping equipments
- emergency switching
- switching off and disconnection for isolation of one circuit or switchboard for maintenance.

#### IEC 60364-5-53 Electrical installations of buildings – Part 5-53: Selection and erection of electrical equipment

Isolation, switching and control standard provides requirement for isolation of circuits, functional switching, and emergency switching.

#### IEC 60204-1 Safety of machinery - Electrical equipment of machines - Part 1: General requirements

standard provides requirements for disconnection of machines.

“Suitability for isolation” is necessary to ensure people safety in open position.

### Suitable for isolation

#### Switch-disconnector

“Isolation” function i.e disconnection from supply is required for all circuits or equipment in order to guarantee the safety of people during repairs or maintenance.

Low voltage electrical installation standards (IEC 60364 series for example) provide requirements to ensure properly this function:

#### Device for isolation shall:

- isolate all live conductors (including neutral but not PEN)
- withstand specified impulse voltage in open position
- have a leakage current below specified values in open position
- be lockable in the “open” position so as to prevent any risk of involuntary reclosing
- ensure that the isolating distance between open contacts of the device is visible or be clearly and reliably indicated by “off” or “open” marking.

These requirements are totally covered with devices compliant to IEC 60947-1/2/3 suitable for isolation.

This characteristics is clearly marked on product by the symbol of switch-disconnector.

DB414421.eps



# Use of LV switches

## Switch-disconnector standards and characteristics

### IEC60947-3 Low-voltage switchgear and controlgear – Part 3:

Switches, disconnectors and fuse-combination units specifies the performances and test of switch-disconnector. The main characteristics of an industrial switch-disconnector are:

- Rated and limiting values for the main circuit: voltage, current, short time withstand in case of short circuit, making current in case of switch on-to short-circuit, rated conditional short-circuit with a specified short-circuit protection.
- Utilization category (for a switching device or a fuse) is a “combination of specified requirements related to the conditions in which the switching device or the fuse fulfils its purpose, selected to represent a characteristic group of practical applications” [IEV 441-17-19]

This characteristic (alphanumerical code) defines requirement linked to a type of load, such as making and breaking current for durability test, minimum number of operation, power factor of the current to make and break.

See example below.

- control circuits: opening / closing Coils and auxiliaries allowing remote opening and/or closing if any.
- auxiliary circuits: O/C Contacts for remote signaling.

Example:

A switch with a rating of 125 A, from the AC23 category must be able to:

- make a  $10 I_n$  (1250 A) current with a  $\cos \phi$  of 0.35
- break a  $8 I_n$  (1000 A) current with a  $\cos \phi$  of 0.35.

Its other characteristics are:

- to withstand a  $12 I_n - 1$  s short-circuit current, which defines the  $I_{cw} = 1500$  A r.m.s. thermal withstand during 1 s.

Utilization category		Characteristic applications
Frequent operations	Non frequent operations	
AC-21A	AC-21B	Resistive loads including moderate overloads ( $\cos \phi = 0.95$ )
AC-22A	AC-22B	Mixed resistive and inductive loads including moderate overloads ( $\cos \phi = 0.65$ )
AC-23A	AC-23B	Motors with cage winding or other loads which are highly inductive ( $\cos \phi = 0.45$ or $0.35$ )

# Choosing a Schneider Electric switch-disconnector

The switch must be chosen according to:

- the characteristics of the network on which it is installed,
- the location and the application,
- coordination with the upstream protection devices (in particular overload and short-circuit).

## Choice criteria

### Network characteristics

Nominal voltage, nominal frequency and nominal current are determined in the same way as for a circuit breaker:

- nominal voltage = nominal voltage of the network
- frequency = network frequency
- nominal current = rated current of a value immediately higher than the downstream load current. Note that the rated current is defined for a given ambient temperature and that a derating may have to be taken into account.

### Location and application

This determines the type and characteristics or main functions that the switch must possess. There are 3 function levels (see table opposite):

- basic functions, virtually common to all switch types:
  - isolation, control, padlocking, safety.
- additional characteristic functions
  - direct formulation of the needs of the user and of the switch environment, i.e.:
    - industrial type performance
    - need for emergency stopping
    - Isc level
    - type of interlocking
    - type of control
    - utilization category
    - mounting system.
- specific functions
  - linked to operation and to installation requirements, i.e.:
    - earth leakage protection
    - motor mechanisms
    - remote opening ("emergency stop" function)
    - withdrawability.

The following table enables choice of switch according to requirements.

- choice table

Comparison of the application table K (see page C-5) and the switch technical data table M (see page C-7) lets you specify which switch range should be used.

### Coordination

All switches must be protected by an overcurrent protection device placed upstream.

The tables below give the coordination performance of circuit breakers and switch-disconnector of main Schneider Electric ranges: in the event of an overload or a short-circuit the circuit breaker proposed in the table will ensure protection of the Switch-disconnector according to its electrodynamic withstand and short-time and permanent withstand.

# Choosing a Schneider Electric switch-disconnector

## Switch-disconnector characteristics according to application

		Main distribution switchboards	Industrial distribution switchboard	Subdistribution switchboards	Final distribution enclosures	Control panel	Local isolation enclosures
Current range		400 to 6300 A	40 to 630 A	≤ 160 A	≤ 125 A	≤ 40/125 A	10 to 630 A
<b>LV switch basic functions</b>							
making and breaking load current		■	■	■	■	■	■
Isolation <sup>[1]</sup>		■	■	■	■	■	■
Padlocking		■	■	■	■	■	■
<b>Characteristics</b>							
Maximum short-circuit level <sup>[2]</sup>		20 to 80 kA	■ I ≤ 160 A: 15 to 25 kA ■ I ≤ 630 A: 20 to 80 kA	■ I ≤ 63 A: 15 kA ■ I ≤ 160 A: 25 kA	10 kA	3 to 5 kA	■ I ≤ 63 A: 10 kA ■ I ≤ 630 A: 25 kA
Utilization category	AC21A AC22A AC23 AC3	■	■ □	■ □	■ □	■	■ ■ I ≤ 63 A
Handle	Rotary Direct front Front extended Side extended	■ ■ □ □	■ □ □ □	■ ■ □ □	□ ■ □ □	■ ■ □ □	■ □ ■ ■
Mounting	On plate Symmetrical rail (45 mm tip)	■ □	□ ■	□ ■	□ ■	■ □	□ □
<b>Specific functions</b>							
Earth leakage protection		□	□	□	□		
Other	Draw-out, auxiliary switches, auxiliary releases, remote control Emergency stop	■ □	■ □	□ □			□ □

**Table K**

■ compulsory.  
□ possible.

[1] with positive break indication or visible isolation

[2] values are indicative. Maximum presumed short-circuit current shall be calculated for each installation

# Choosing a Schneider Electric switch-disconnector

## The switches available in the Schneider Electric offer

Schneider Electric offers its customers several ranges of switches.

Choice depends on:

- the application
- the additional functions to be implemented (accessories, installation, residual current protection, etc.).

The following table summarises the possibilities offered by all the Schneider Electric ranges according to the applications described above.

Applications Products	Incoming switches for					Local isolation switches Local isolation enclosures
	Main distribution switchboards 400-6300 A	Industrial distribution switchboards 400-630 A	Subdistribution switchboards ≤ 160 A	Final distribution enclosures ≤ 125 A	Control panels ≤ 40/125 A	
Vario					■	■
Acti 9 iSW / iID (modular profile)				■		□
Acti 9 iSW-NA (modular profile)				□		■
Compact INS ≤ 160 (modular profile)		■	■	■		■
NG125 NA (modular profile)			■	■		■
Compact INS (industrial)	■	■				■
Compact NSXm NA (Modular / Industrial)			■	□		□
Compact NSX-NA (industrial)	□	■	□			■
Masterpact NA/HA/HF (industrial)	■					

Table L

- very common
- fairly common.



# Choosing a Schneider Electric switch-disconnector

## Switch-disconnector range technical data

Table M below lists the main technical data of the switches in the Schneider Electric ranges.

Range	Vario	Acti 9 iSW	iSW NA	iID	Multi 9 NG125 NA	Compact INS	INV	NSXm NA	NSX NA	NS NA	Masterpact NA	HA	HF
Clip-on on rail		■	■	■	■	■ [3]	■ [3]	■	■	■			
Main functions	Isolation	■	■ [5]	■	■	■	■	■	■	■	■	■	■
	Positive break indication	■	■	■	■	■	■	■	■	■	■	■	■
	Visible isolation						■						
Emergency stop	Manual [7]	■			■	■ [4]	■ [4]	■ [4]	■ [4]	■ [4]	■ [4]	■ [4]	■ [4]
	Remote (MN coil)			■ [6]	■ [6]	■ [6]		■ [6]	■ [6]	■ [6]	■ [6]	■ [6]	■ [6]
Other functions	Residual current			■	■ [8]				■ [8]		■	■	■
	Remote opening (MX)			■	■			■	■	■	■	■	■
	Remote control (Open Close)								■	■ [9]	■	■	■
Fixed/drawout	Fixed	■	■	■	■	■	■	■	■	■	■	■	■
	Drawout								■	■ [9]	■	■	■
On/Off indication contact	■	■	■	■ [1]	■ [1]	■ [2]	■ [2]	■	■	■	■	■	■
Ratings (A)	12	■											
	16			■									
	20	■											
	25	■		■									
	32	■		■									
	40	■	■	■		■							
	50		■	■				■					
	63	■	■	■	■	■							
	80	■	■	■	■	■							
	100		■	■	■	■	■	■	■				
	125	■	■		■	■							
	160	■				■	■	■	■				
	175	■											
	250					■	■		■				
	320					■	■						
	400					■	■		■				
	500					■	■						
	630					■	■		■	■		■	■
	800					■	■			■	■	■	■
	1000					■	■			■	■	■	■
	1250					■	■			■	■	■	■
	1600					■	■			■	■	■	■
	2000					■	■			■	■	■	■
	2500					■	■			■	■	■	■
	3200									■	■	■	■
	4000										■	■	■
	5000										■	■	■
	6300										■	■	■

Table M

[1] SD auxiliary contact available on iID.  
 [2] OF contact and CAO or CAF.  
 [3] Only 40 to 160 A (modular profile).  
 [4] Specific INS/INV emergency stop switches.  
 [5] Only on ratings 40/63/100/125. iSW 20 and 32 are switch without isolation function according to IEC 60669-1.  
 [6] With MN auxiliaries.  
 [7] Yellow front plate/red handle.  
 [8] Associated Vigî bloc.  
 [9] Option available up to 1600 A.

# Switch-disconnector - Circuit breaker coordination

Upstream: iC40/iDPN, iC60, C120, NG125, Compact NSXm, NSX

Downstream: iSW-NA, iID

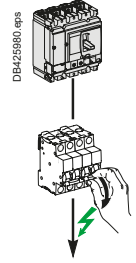

Ue ≤ 415 V AC

Downstream	Switch-disconnector	iSW-NA				iID [1]					
		Rating (A)	40	63	80	100	25	40	63	100	125
		Icu (A)	800	1260	1600	2000	500	800	1260	1200	1500
	Icm (kA)	5	5	5	5	5	5	5	5	5	

Upstream Circuit breaker	Rating or setting	Icu (kA) 415 V	Switch-disconnector conditional short-circuit current and related making capacity								
			T	T	T	T	T	T	T	T	T
iC40/iDPN All curves	≤ 25	6	T	T	T	T	T	T	T	T	T
	32	6	T	T	T	T	T	T	T	T	T
	40	6	T	T	T	T	T	T	T	T	T
iC40N/iDPNN All curves	≤ 25	10	T	T	T	T	T	T	T	T	T
	32	10	T	T	T	T	T	T	T	T	T
	40	10	T	T	T	T	T	T	T	T	T
iC60N/H/L All curves	≤ 25	10/15/25	T	T	T	T	T	T	T	T	T
	32	10/15/20	T	T	T	T	T	T	T	T	T
	40	10/15/20	T	T	T	T	T	T	T	T	T
	50-63	10/15/15	T	T	T	T	T	T	T	T	T
C120N/H All curves	63	10/15		T	T	T	T <sup>[2]</sup>	T <sup>[2]</sup>	T	T	T
	80	10/15				10/17	10/17			10/17	10/17
	100	10/15									10/17
	125	10/15									10/17
NG125N All curves	≤ 40	25	16/27	16/27	16/27	16/27		16/27	16/27	16/27	16/27
	50-63	25		16/27	16/27	16/27		16/27 <sup>[2]</sup>	16/27	16/27	16/27
	80	25				10/17				10/17	10/17
	100	25				10/17					10/17
NG125H C Curves	≤ 40	36	16/27	16/27	16/27	16/27		16/27	16/27	16/27	16/27
	50-63	36		16/27	16/27	16/27		16/27 <sup>[2]</sup>	16/27	16/27	16/27
	80	36			10/17	10/17				10/17	10/17
NG125L All curves	≤ 40	50	20/40	20/40	20/40	20/40		20/40	20/40	20/40	20/40
	50-63	50		16/27	16/27	16/27		16/27 <sup>[2]</sup>	16/27	16/27	16/27
	80	50			10/17	10/17				10/17	10/17
NSXm  Icu 415V: E/B/F/N/H 16/25/36/50/70	≤ 25	*	5/7,65	5/7,65	5/7,65	5/7,65	5/7,65	5/7,65	5/7,65	5/7,65	5/7,65
	32	*	5/7,65	5/7,65	5/7,65	5/7,65		5/7,65	5/7,65	5/7,65	5/7,65
	40	*	5/7,65	5/7,65	5/7,65	5/7,65		5/7,65	5/7,65	5/7,65	5/7,65
	50	*		5/7,65	5/7,65	5/7,65			5/7,65	5/7,65	5/7,65
	63	*		5/7,65	5/7,65	5/7,65			5/7,65	5/7,65	5/7,65
	80	*			5/7,65	5/7,65				5/7,65	5/7,65
NSX100  Icu 415V: B/F/N/H/S/L 25/36/50/70/100/150	≤ 25	*	5/7,65	5/7,65	5/7,65	5/7,65	5/7,65	5/7,65	5/7,65	5/7,65	5/7,65
	32	*	5/7,65	5/7,65	5/7,65	5/7,65		5/7,65	5/7,65	5/7,65	5/7,65
	40	*	5/7,65	5/7,65	5/7,65	5/7,65		5/7,65	5/7,65	5/7,65	5/7,65
	50	*		5/7,65	5/7,65	5/7,65			5/7,65	5/7,65	5/7,65
	63	*		5/7,65	5/7,65	5/7,65			5/7,65	5/7,65	5/7,65
	80	*			5/7,65	5/7,65				5/7,65	5/7,65
NSX160 B/F/N/H/S/L	125	*									5/7,65
	160	*									5/7,65

**T** : Protection of the switch-disconnector is ensured but combination not very relevant

**T** : Switch-disconnector is totally coordinated up to Icu of circuit breaker installed on supply side

36/75 : Switch-disconnector is protected up to 36 kA rms / 75 kA.

: Protection of the switch-disconnector is not ensured

[1] See Guide CA908023 for additional information.

[2] Short-circuit protection only. Overload protection of the iID shall be provided by another way.

# Switch-disconnector - Circuit breaker coordination

Upstream: iC40/iDPN, iC60, C120, NG125, Compact NSXm, NSX100, NSX160

Downstream: iSW, NG125NA, Compact NSXm NA

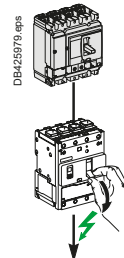

Ue ≤ 415 V AC

Downstream	Switch-disconnector	iSW				NG125NA				NSXm NA			
		Rating (A)	40	63	100	125	63	80	100	125	50	100	160
		Icw (kA)	1.5	1.5	1.5	1.5	1.5	1.5	1.5	1.5	0.9	1.5	1.5
		Icm (kA)	5	5	5	5	2	2	2	2	1.38	2.13	2.13

Upstream Circuit breaker	Rating or setting	Icu (kA) 415 V	Switch-disconnector conditional short-circuit current and related making capacity											
			iSW 40	iSW 63	iSW 100	iSW 125	NG125NA 63	NG125NA 80	NG125NA 100	NG125NA 125	NSXm NA 50	NSXm NA 100	NSXm NA 160	
iC40/iDPN All curves	≤ 25	6	T	T	T	T	T	T	T	T	T	T	T	T
	32	6	T	T	T	T	T	T	T	T	T	T	T	T
	40	6	T	T	T	T	T	T	T	T	T	T	T	T
iC40N/iDPNN All curves	≤ 25	10	T	T	T	T	T	T	T	T	T	T	T	T
	32	10	T	T	T	T	T	T	T	T	T	T	T	T
	40	10	T	T	T	T	T	T	T	T	T	T	T	T
iC60N/H/L All Curves	≤ 25	10/15/25	T	T	T	T	T	T	T	T	T	T	T	T
	32-40	10/15/20	T	T	T	T	T	T	T	T	T	T	T	T
	50	10/15/15	T	T	T	T	T	T	T	T	T	T	T	T
	63	10/15/15	T	T	T	T	T	T	T	T	T	T	T	T
C120N/H All curves	63	10/15		T	T	T			T	T	T		T	T
	80	10/15			10/17	10/17			T	T	T		T	T
	100	10/15				10/17			T	T	T		T	T
	125	10/15				10/17			T	T	T		T	T
NG125N B-C-D Curves	≤ 40	25	16/27	16/27	16/27	16/27	T	T	T	T	T	T	T	T
	50	25		16/27	16/27	16/27		T	T	T	T	T	T	T
	63	25		16/27	16/27	16/27		T	T	T	T	T	T	T
	80	25			10/17	10/17			T	T	T	T	T	T
	100	25				10/17			T	T	T	T	T	T
NG125H C Curve	≤ 40	36	16/27	16/27	16/27	16/27	T	T	T	T	T	T	T	T
	50	36		16/27	16/27	16/27		T	T	T	T	T	T	T
	63	36		16/27	16/27	16/27		T	T	T	T	T	T	T
	80	36			10/17	10/17			T	T	T	T	T	T
NG125L B-C-D Curves	≤ 40	50	20/40	20/40	20/40	20/40	T	T	T	T	T	T	T	T
	50	50		16/27	16/27	16/27		T	T	T	T	T	T	T
	63	50		16/27	16/27	16/27			T	T	T	T	T	T
	80	50			10/17	10/17			T	T	T	T	T	T
NSXm Icu 415V: E/B/F/N/H 16/25/36/50/70	≤ 40	*	5/7,65	5/7,65	5/7,65	5/7,65	T	T	T	T	T	T	T	T
	50	*		5/7,65	5/7,65	5/7,65		T	T	T	T	T	T	T
	63	*		5/7,65	5/7,65	5/7,65		T	T	T	T	T	T	T
	80	*			5/7,65	5/7,65			T	T	T	T	T	T
	100	*				5/7,65			T	T	T	T	T	T
	125	*				5/7,65				T	T	T	T	T
NSX100 Icu 415V: B/F 25/36	≤ 40	*	5/7,65	5/7,65	5/7,65	5/7,65	T	T	T	T	T	T	T	T
	50	*		5/7,65	5/7,65	5/7,65		T	T	T	T	T	T	T
	63	*		5/7,65	5/7,65	5/7,65		T	T	T	T	T	T	T
	80	*			5/7,65	5/7,65			T	T	T	T	T	T
NSX160 B/F	125	*				5/7,65				T				T
	160	*				5/7,65				T				T
NSX100 Icu 415V: N/H 50/70	≤ 40	*	5/7,65	5/7,65	5/7,65	5/7,65	36/75	36/75	36/75	36/75	36/75	T	T	T
	50	*		5/7,65	5/7,65	5/7,65	36/75	36/75	36/75	36/75	36/75	T	T	T
	63	*		5/7,65	5/7,65	5/7,65	36/75	36/75	36/75	36/75	36/75		T	T
	80	*			5/7,65	5/7,65		36/75	36/75	36/75	36/75		T	T
NSX160 N/H	125	*				5/7,65				36/75				T
	160	*				5/7,65				36/75				T
NSX100 Icu 415V: S/L 100/150	≤ 40	*	5/7,65	5/7,65	5/7,65	5/7,65	36/75	36/75	36/75	36/75	70/150	70/150	70/150	70/150
	50	*		5/7,65	5/7,65	5/7,65	36/75	36/75	36/75	36/75	70/150	70/150	70/150	70/150
	63	*		5/7,65	5/7,65	5/7,65	36/75	36/75	36/75	36/75	70/150	70/150	70/150	70/150
	80	*			5/7,65	5/7,65		36/75	36/75	36/75	70/150	70/150	70/150	70/150
NSX160 S/L	125	*				5/7,65				36/75				70/150
	160	*				5/7,65				36/75				70/150

T : Protection of the switch-disconnector is ensured but combination not very relevant

T : Switch-disconnector is totally coordinated up to Icu of circuit breaker installed on supply side

36/75 : Switch-disconnector is protected up to 36 kA rms / 75 kA

: Protection of the switch-disconnector is not ensured

# Switch-disconnector - Circuit breaker coordination

Upstream: iC60, C120, NG125

Downstream: Compact INS40 to INS250, INV100 to INV250

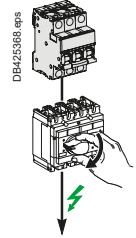

Ue ≤ 415 V AC

Downstream	Switch-disconnector	INS40	INS63	INS80	INS100	INS 250-100 INV100	INS125	INS160	INS 250-160 INV160	INS 250-200 INV200	INS250 INV250
	Ith (A) 60°	40	63	80	100	100	125	160	160	250	250
	Icw (kA)	3	3	3	5.5	8.5	5.5	5.5	8.5	8.5	8.5
	Icm (kA)	15	15	15	20	30	20	20	30	30	30

Upstream	Rating	Icu (kA)	Switch-disconnector conditional short-circuit current and related making capacity											
Circuit breaker	415 V													
<b>iC60N</b> B-C-D Curves	≤ 32	10	T	T	T	T	T	T	T	T	T	T	T	T
	40	10	T	T	T	T	T	T	T	T	T	T	T	T
	50	10		T	T	T	T	T	T	T	T	T	T	T
	63	10		T	T	T	T	T	T	T	T	T	T	T
<b>iC60H</b> B-C-D Curves	≤ 32	15	T	T	T	T	T	T	T	T	T	T	T	T
	40	15	T	T	T	T	T	T	T	T	T	T	T	T
	50	15		T	T	T	T	T	T	T	T	T	T	T
	63	15		T	T	T	T	T	T	T	T	T	T	T
<b>iC60L</b> B-C-D-K-Z Curves	≤ 25	25	T	T	T	T	T	T	T	T	T	T	T	T
	32	20	T	T	T	T	T	T	T	T	T	T	T	T
	40	20		T	T	T	T	T	T	T	T	T	T	T
	50	15		T	T	T	T	T	T	T	T	T	T	T
	63	15		T	T	T	T	T	T	T	T	T	T	T
<b>C120N</b> B-C-D Curves	63	10		T	T	T	T	T	T	T	T	T	T	T
	80	10			T	T	T	T	T	T	T	T	T	T
	100	10				T	T	T	T	T	T	T	T	T
	2, 3, 4P 415 V	125	10					T	T	T	T	T	T	T
<b>C120H</b> B-C-D Curves	63	15		T	T	T	T	T	T	T	T	T	T	T
	80	15			T	T	T	T	T	T	T	T	T	T
	100	15				T	T	T	T	T	T	T	T	T
	2, 3, 4P 415 V	125	15					T	T	T	T	T	T	T
<b>NG125N</b> B-C-D Curves	≤ 40	25	T	T	T	T	T	T	T	T	T	T	T	T
	63	25		T	T	T	T	T	T	T	T	T	T	T
	80	25			T	T	T	T	T	T	T	T	T	T
	100	25				T	T	T	T	T	T	T	T	T
<b>NG125H</b> C Curves	≤ 40	36	T	T	T	T	T	T	T	T	T	T	T	T
	63	36		T	T	T	T	T	T	T	T	T	T	T
	80	36			T	T	T	T	T	T	T	T	T	T
	100	36				T	T	T	T	T	T	T	T	T
<b>NG125L</b> B-C-D Curves	≤ 40	50	T	T	T	T	T	T	T	T	T	T	T	T
	63	50		T	T	T	T	T	T	T	T	T	T	T
	80	50			T	T	T	T	T	T	T	T	T	T
						T	T	T	T	T	T	T	T	T

- T : Protection of the switch-disconnector is ensured but combination not very relevant
- T : Switch-disconnector is totally coordinated up to Icu of circuit breaker installed on supply side
- 36/75 : Switch-disconnector is protected up to 36 kA rms / 75 kA
- : Protection of the switch-disconnector is not ensured

# Switch-disconnector - Circuit breaker coordination

Upstream: Compact NSXm

Downstream: Compact INS40 to 250, Compact INV100 to 250

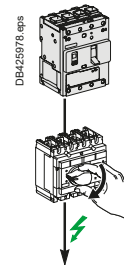

Ue ≤ 440 V AC

Downstream	Switch-disconnector	INS40	INS63	INS80	INS100	INS250-100 INV100	INS125	INS160	INS250-160 INV160	INS250-200 INV200	INS250 INV250
	Ith A 60°	40	63	80	100	100	125	160	160	200	200
	Icw (kA)	3	3	3	5.5	8.5	5.5	5.5	8.5	8.5	8.5
	Icm (kA)	15	15	15	20	30	20	20	30	30	30

Upstream	Icu (kA)		Ir	Switch-disconnector conditional short-circuit current and related making capacity									
Circuit breaker:	415 V	440 V		INS40	INS63	INS80	INS100	INS250-100 INV100	INS125	INS160	INS250-160 INV160	INS250-200 INV200	INS250 INV250
<b>NSXm E</b> TMD, Micrologic	16	10	Ir ≤ 40	T	T	T	T	T	T	T	T	T	T
			Ir ≤ 50		T	T	T	T	T	T	T	T	T
				Ir ≤ 63		T	T	T	T	T	T	T	T
				Ir ≤ 80			T	T	T	T	T	T	T
				Ir ≤ 100				T	T	T	T	T	T
				Ir ≤ 125					T	T	T	T	T
				Ir ≤ 160						T	T	T	T
<b>NSXm B</b> TMD, Micrologic	25	20	Ir ≤ 40	T	T	T	T	T	T	T	T	T	T
			Ir ≤ 50		T	T	T	T	T	T	T	T	T
				Ir ≤ 63		T	T	T	T	T	T	T	T
				Ir ≤ 80			T	T	T	T	T	T	T
				Ir ≤ 100				T	T	T	T	T	T
				Ir ≤ 125					T	T	T	T	T
				Ir ≤ 160						T	T	T	T
<b>NSXm F</b> TMD, Micrologic	36	35	Ir ≤ 40	T	T	T	T	T	T	T	T	T	T
			Ir ≤ 50		T	T	T	T	T	T	T	T	T
				Ir ≤ 63		T	T	T	T	T	T	T	T
				Ir ≤ 80			T	T	T	T	T	T	T
				Ir ≤ 100				T	T	T	T	T	T
				Ir ≤ 125					T	T	T	T	T
				Ir ≤ 160						T	T	T	T
<b>NSXm N</b> TMD, Micrologic	50	50	Ir ≤ 40	36/75	36/75	36/75	T	T	T	T	T	T	T
			Ir ≤ 50		36/75	36/75	T	T	T	T	T	T	T
				Ir ≤ 63		36/75	36/75	T	T	T	T	T	T
				Ir ≤ 80			36/75	T	T	T	T	T	T
				Ir ≤ 100				T	T	T	T	T	T
				Ir ≤ 125					T	T	T	T	T
				Ir ≤ 160						T	T	T	T
<b>NSXm H</b> TMD, Micrologic	70	65	Ir ≤ 40	36/75	36/75	36/75	T	T	T	T	T	T	T
			Ir ≤ 50		36/75	36/75	T	T	T	T	T	T	T
				Ir ≤ 63		36/75	36/75	T	T	T	T	T	T
				Ir ≤ 80			36/75	T	T	T	T	T	T
				Ir ≤ 100				T	T	T	T	T	T
				Ir ≤ 125					T	T	T	T	T
				Ir ≤ 160						T	T	T	T

- T : Protection of the switch-disconnector is ensured but combination not very relevant
- T : Switch-disconnector is totally coordinated up to Icu of circuit breaker installed on supply side
- 36/75 : Switch-disconnector is protected up to 36 kA rms / 75 kA
- : Protection of the switch-disconnector is not ensured



# Switch-disconnector - Circuit breaker coordination

Upstream: Compact NSX100 to 250

Downstream: Compact INS40 to INS250, INV100 to INV250

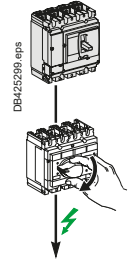

Ue ≤ 440 V AC

Downstream	Switch-disconnector	INS40	INS63	INS80	INS100	INS250-100 INV100	INS125	INS160	INS250-160 INV160	INS250-200 INV200	INS250 INV250	
		Ith A 60°	40	63	80	100	100	125	160	160	200	250
		Icw (kA)	3	3	3	5.5	8.5	5.5	5.5	8.5	8.5	8.5
		Icm (kA)	15	15	15	20	30	20	20	30	30	30

Upstream circuit breaker	Icu (kA)			Ir	Switch-disconnector conditional short-circuit current and related making capacity													
	415V	440V																
<b>NSX100B</b> <b>NSX160B</b> TMD / TMG / Micrologic	25	20	Ir ≤ 40	T	T	T	T	T	T	T	T	T	T	T	T	T	T	
			Ir ≤ 63		T	T	T	T	T	T	T	T	T	T	T	T	T	
			Ir ≤ 80			T	T	T	T	T	T	T	T	T	T	T	T	T
			Ir ≤ 100				T	T	T	T	T	T	T	T	T	T	T	T
			Ir ≤ 125						T	T	T	T	T	T	T	T	T	T
<b>NSX250B</b> TMD / TMG / Micrologic	25	20	Ir ≤ 40	T	T	T	T	T	T	T	T	T	T	T	T	T	T	
			Ir ≤ 63		T	T	T	T	T	T	T	T	T	T	T	T	T	
			Ir ≤ 80			T	T	T	T	T	T	T	T	T	T	T	T	T
			Ir ≤ 100				T	T	T	T	T	T	T	T	T	T	T	T
			Ir ≤ 125						T	T	T	T	T	T	T	T	T	T
<b>NSX100F</b> <b>NSX160F</b> TMD / TMG / Micrologic	36	35	Ir ≤ 40	36/75	36/75	36/75	T	T	T	T	T	T	T	T	T	T	T	
			Ir ≤ 63		36/75	36/75	T	T	T	T	T	T	T	T	T	T	T	
			Ir ≤ 80			36/75	T	T	T	T	T	T	T	T	T	T	T	T
			Ir ≤ 100				T	T	T	T	T	T	T	T	T	T	T	T
			Ir ≤ 125						T	T	T	T	T	T	T	T	T	T
<b>NSX250F</b> TMD / TMG / Micrologic	36	35	Ir ≤ 40	25/52	25/52	25/52	T	T	T	T	T	T	T	T	T	T	T	
			Ir ≤ 63		25/52	25/52	T	T	T	T	T	T	T	T	T	T	T	
			Ir ≤ 80			25/52	T	T	T	T	T	T	T	T	T	T	T	T
			Ir ≤ 100				T	T	T	T	T	T	T	T	T	T	T	T
			Ir ≤ 125						T	T	T	T	T	T	T	T	T	T
<b>NSX100N/H</b> <b>NSX160N/H</b> TMD / TMG / Micrologic	50/70	50/65	Ir ≤ 40	25/52	25/52	25/52	T	T	T	T	T	T	T	T	T	T	T	
			Ir ≤ 63		25/52	25/52	T	T	T	T	T	T	T	T	T	T	T	
			Ir ≤ 80			25/52	T	T	T	T	T	T	T	T	T	T	T	T
			Ir ≤ 100				T	T	T	T	T	T	T	T	T	T	T	T
			Ir ≤ 125						T	T	T	T	T	T	T	T	T	T
<b>NSX250N/H</b> TMD / TMG / Micrologic	50/70	50/65	Ir ≤ 40	25/52	25/52	25/52	T	T	T	T	T	T	T	T	T	T	T	
			Ir ≤ 63		25/52	25/52	T	T	T	T	T	T	T	T	T	T	T	
			Ir ≤ 80			25/52	T	T	T	T	T	T	T	T	T	T	T	T
			Ir ≤ 100				T	T	T	T	T	T	T	T	T	T	T	T
			Ir ≤ 125						T	T	T	T	T	T	T	T	T	T
<b>NSX100S/L/R</b> TMD / TMG / Micrologic	100/ 150/ 200	90/ 130/ 200	Ir ≤ 40	36/75	36/75	36/75	65/143	T	65/143	65/143	T	T	T	T	T	T	T	
			Ir ≤ 63		36/75	36/75	65/143	T	65/143	65/143	T	T	T	T	T	T	T	
			Ir ≤ 80			36/75	65/143	T	65/143	65/143	T	T	T	T	T	T	T	
			Ir ≤ 100				65/143	T	65/143	65/143	T	T	T	T	T	T	T	
			<b>NSX160S/L</b> TMD / TMG / Micrologic	100/ 150	90/ 130	Ir ≤ 40	36/75	36/75	36/75	65/143	T	65/143	65/143	T	T	T	T	T
Ir ≤ 63		36/75				36/75	65/143	T	65/143	65/143	T	T	T	T	T	T	T	
Ir ≤ 80						36/75	65/143	T	65/143	65/143	T	T	T	T	T	T	T	
Ir ≤ 100							65/143	T	65/143	65/143	T	T	T	T	T	T	T	
Ir ≤ 125									65/143	65/143	T	T	T	T	T	T	T	
<b>NSX250S/L/R</b> TMD / TMG / Micrologic	100/ 150/ 200	90/ 130/ 200	Ir ≤ 40	25/52	25/52	25/52	65/143	T	65/143	65/143	T	T	T	T	T	T	T	
			Ir ≤ 63		25/52	25/52	65/143	T	65/143	65/143	T	T	T	T	T	T	T	
			Ir ≤ 80			25/52	65/143	T	65/143	65/143	T	T	T	T	T	T	T	
			Ir ≤ 100				65/143	T	65/143	65/143	T	T	T	T	T	T	T	
			Ir ≤ 125						65/143	65/143	T	T	T	T	T	T	T	

- T** : Protection of the switch-disconnector is ensured but combination not very relevant
- T** : Switch-disconnector is totally coordinated up to Icu of circuit breaker installed on supply side
- 36/75** : Switch-disconnector is protected up to 36 kA rms / 75 kA
- : Protection of the switch-disconnector is not ensured

# Switch-disconnector - Circuit breaker coordination

Upstream: Compact NSX100 to 630

Downstream: Compact NSX100 to 630 NA

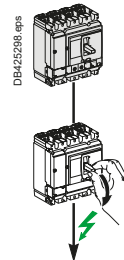

Ue ≤ 440 V AC

Downstream	Switch-disconnector	NSX100NA	NSX160NA	NSX250NA	NSX400NA	NSX630NA	
		Ith A 60°	100	160	250	400	630
		Icw (kA)	1.8	2.5	3.5	5	6
	Icm (kA)	2.6	3.6	4.9	7.1	8.5	

Upstream Circuit breaker	Icu (kA)		I <sub>r</sub>	Switch-disconnector conditionnal short-circuit current and related making capacity				
	415 V	440 V						
NSX100B	25	20	I <sub>r</sub> ≤ 100	T	T	T	T	T
NSX160B			I <sub>r</sub> ≤ 160	T	T	T	T	
NSX250B			I <sub>r</sub> ≤ 200	T	T	T	T	
TMD / TMG / Micrologic			I <sub>r</sub> ≤ 250			T	T	T
NSX100F	36	35	I <sub>r</sub> ≤ 100	T	T	T	T	T
NSX160F			I <sub>r</sub> ≤ 160	T	T	T	T	
NSX250F			I <sub>r</sub> ≤ 200		T	T	T	T
TMD / TMG / Micrologic			I <sub>r</sub> ≤ 250			T	T	T
NSX400F	36	30	I <sub>r</sub> = 100 [1]	T	T	T	T	T
NSX630F			I <sub>r</sub> ≤ 160	T	T	T	T	
Micrologic			I <sub>r</sub> ≤ 250		T	T	T	T
			I <sub>r</sub> ≤ 400				T	T
			I <sub>r</sub> ≤ 630				T	T
NSX100N	50	50	I <sub>r</sub> ≤ 100	T	T	T	T	T
NSX160N			I <sub>r</sub> ≤ 160	T	T	T	T	
NSX250N			I <sub>r</sub> ≤ 200		T	T	T	T
TMD / TMG / Micrologic			I <sub>r</sub> ≤ 250			T	T	T
NSX400N	50	42	I <sub>r</sub> = 100 [1]	T	T	T	T	T
NSX630N			I <sub>r</sub> ≤ 160	T	T	T	T	
Micrologic			I <sub>r</sub> ≤ 250		T	T	T	T
			I <sub>r</sub> ≤ 400				T	T
			I <sub>r</sub> ≤ 630				T	T
NSX100H	70	65	I <sub>r</sub> ≤ 100	T	T	T	T	T
NSX160H			I <sub>r</sub> ≤ 160	T	T	T	T	
NSX250H			I <sub>r</sub> ≤ 200		T	T	T	T
TMD / TMG / Micrologic			I <sub>r</sub> ≤ 250			T	T	T
NSX400H	70	65	I <sub>r</sub> = 100 [1]	T	T	T	T	T
NSX630H			I <sub>r</sub> ≤ 160	T	T	T	T	
Micrologic			I <sub>r</sub> ≤ 250		T	T	T	T
			I <sub>r</sub> ≤ 400				T	T
			I <sub>r</sub> ≤ 630				T	T
NSX100S	100	90	I <sub>r</sub> ≤ 100	T	T	T	T	T
NSX160S			I <sub>r</sub> ≤ 160	T	T	T	T	
NSX250S			I <sub>r</sub> ≤ 200		T	T	T	T
TMD / TMG / Micrologic			I <sub>r</sub> ≤ 250			T	T	T
NSX400S	100	90	I <sub>r</sub> = 100 [1]	T	T	T	T	T
NSX630S			I <sub>r</sub> ≤ 160	T	T	T	T	
Micrologic			I <sub>r</sub> ≤ 250		T	T	T	T
			I <sub>r</sub> ≤ 400				T	T
			I <sub>r</sub> ≤ 630				T	T
NSX100L	150	130	I <sub>r</sub> ≤ 100	T	T	T	T	T
NSX160L			I <sub>r</sub> ≤ 160	T	T	T	T	
NSX250L			I <sub>r</sub> ≤ 200		T	T	T	T
TMD / TMG / Micrologic			I <sub>r</sub> ≤ 250			T	T	T
NSX400L	150	130	I <sub>r</sub> = 100 [1]	T	T	T	T	T
NSX630L			I <sub>r</sub> ≤ 160	T	T	T	T	
Micrologic			I <sub>r</sub> ≤ 250		T	T	T	T
			I <sub>r</sub> ≤ 400				T	T
			I <sub>r</sub> ≤ 630				T	T
NSX100R	200	200	I <sub>r</sub> ≤ 100	T	T	T	T	T
NSX250R			I <sub>r</sub> ≤ 160	T	T	T	T	
TMD / TMG / Micrologic			I <sub>r</sub> ≤ 200		T	T	T	T
	I <sub>r</sub> ≤ 250				T	T		
NSX400R	200	200	I <sub>r</sub> = 100 [1]	T	T	T	T	T
NSX630R			I <sub>r</sub> ≤ 160	T	T	T	T	
Micrologic			I <sub>r</sub> ≤ 250		T	T	T	T
			I <sub>r</sub> ≤ 400				T	T
			I <sub>r</sub> ≤ 630				T	T

**T** : Protection of the switch-disconnector is ensured but combination not very relevant

**T** : Switch-disconnector is totally coordinated up to Icu of circuit breaker installed on supply side

: Protection of the switch-disconnector is not ensured

[1] NSX400 with Micrologic 250 A can be set down to 100 A.

# Switch-disconnector - Circuit breaker coordination

Upstream: Compact NSX400 to 630

Downstream: Compact INS/INV100 to 630

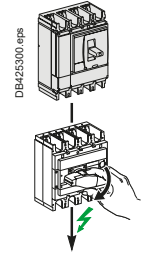

Ue ≤ 440 V AC

Downstream	Switch-disconnector	INS100	INS250-100 INV100	INS125	INS160	INS250-160 INV160	INS250-200 INV200	INS250-INV250	INS320-INV320	INS400-INV400	INS500-INV500	INS630-INV630	INS630b-INV630b
		Ith A 60°	100	100	125	160	160	200	250	320	400	500	630
	Icw (kA)	5.5	8.5	5.5	5.5	8.5	8.5	8.5	20	20	20	20	35
	Icm (kA)	20	30	20	20	30	30	30	50	50	50	50	75

Upstream Circuit breaker	Icu (kA)		Setting Ir	Switch-disconnector conditional short-circuit current and related making capacity											
	415 V	440 V		INS100	INS250-100 INV100	INS125	INS160	INS250-160 INV160	INS250-200 INV200	INS250-INV250	INS320-INV320	INS400-INV400	INS500-INV500	INS630-INV630	INS630b-INV630b
NSX400F NSX630F Micrologic	36	30	Ir = 100 [1]	16/32	T	16/32	16/32	T	T	T	T	T	T	T	T
			Ir ≤ 160			16/32	T	T	T	T	T	T	T	T	T
			Ir ≤ 200						T	T	T	T	T	T	T
			Ir ≤ 250							T	T	T	T	T	T
			Ir ≤ 320								T	T	T	T	T
			Ir ≤ 400									T	T	T	T
			Ir ≤ 500										T	T	T
NSX400N NSX630N Micrologic	50	42	Ir = 100 [1]	16/32	36/75	16/32	16/32	36/75	36/75	36/75	T	T	T	T	T
			Ir ≤ 160				16/32	36/75	36/75	36/75	T	T	T	T	T
			Ir ≤ 200						36/75	36/75	T	T	T	T	T
			Ir ≤ 250							36/75	T	T	T	T	T
			Ir ≤ 320								T	T	T	T	T
			Ir ≤ 400									T	T	T	T
			Ir ≤ 500										T	T	T
NSX400H NSX630H Micrologic	70	65	Ir = 100 [1]	16/32	36/75	16/32	16/32	36/75	36/75	36/75	T	T	T	T	T
			Ir ≤ 160				16/32	36/75	36/75	36/75	T	T	T	T	T
			Ir ≤ 200						36/75	36/75	T	T	T	T	T
			Ir ≤ 250							36/75	T	T	T	T	T
			Ir ≤ 320								T	T	T	T	T
			Ir ≤ 400									T	T	T	T
			Ir ≤ 500										T	T	T
NSX400S NSX630S Micrologic	100	90	Ir = 100 [1]	16/32	36/75	16/32	16/32	36/75	36/75	36/75	T	T	T	T	T
			Ir ≤ 160				16/32	36/75	36/75	36/75	T	T	T	T	T
			Ir ≤ 200						36/75	36/75	T	T	T	T	T
			Ir ≤ 250							36/75	T	T	T	T	T
			Ir ≤ 320								T	T	T	T	T
			Ir ≤ 400									T	T	T	T
			Ir ≤ 500										T	T	T
NSX400L NSX630L Micrologic	150	130	Ir = 100 [1]	16/32	36/75	16/32	16/32	36/75	36/75	36/75	T	T	T	T	T
			Ir ≤ 160				16/32	36/75	36/75	36/75	T	T	T	T	T
			Ir ≤ 200						36/75	36/75	T	T	T	T	T
			Ir ≤ 250							36/75	T	T	T	T	T
			Ir ≤ 320								T	T	T	T	T
			Ir ≤ 400									T	T	T	T
			Ir ≤ 500										T	T	T
NSX400R NSX630R Micrologic	200	200	Ir = 100 [1]	16/32	36/75	16/32	16/32	36/75	36/75	36/75	150/330	150/330	150/330	150/330	T
			Ir ≤ 160				16/32	36/75	36/75	36/75	150/330	150/330	150/330	150/330	T
			Ir ≤ 200						36/75	36/75	150/330	150/330	150/330	150/330	T
			Ir ≤ 250							36/75	150/330	150/330	150/330	150/330	T
			Ir ≤ 320								150/330	150/330	150/330	150/330	T
			Ir ≤ 400									150/330	150/330	150/330	T
			Ir ≤ 500										150/330	150/330	T
Ir ≤ 630											150/330	T			

- T : Protection of the switch-disconnector is ensured but combination not very relevant
- T : Switch-disconnector is totally coordinated up to Icu of circuit breaker installed on supply side
- 36/75 : Switch-disconnector is protected up to 36 kA rms / 75 kA
- : Protection of the switch-disconnector is not ensured

[1] NSX400 with Micrologic 250 A can be set down to 100 A.



# Switch-disconnector - Circuit breaker coordination

Upstream: Compact NS630b to 3200, Masterpact MTZ1

Downstream: Compact INS/INV500 to 2500

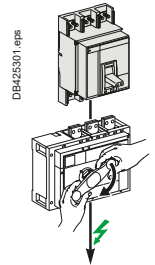

Ue ≤ 440 V AC

Downstream	Switch-disconnector	INS500	INS630	INS630b	INS800	INS1000	INS1250	INS1600	INS2000	INS2500
	INV500	INV630	INV630b	INV800	INV1000	INV1250	INV1600	INV2000	INV2500	
	Ith A 60°	500	630	630	800	1000	1250	1600	2000	2500
	Icw (kA)	20	20	35	35	35	35	35	50	50
Icm (kA)	50	50	75	75	75	75	75	105	105	

Upstream Circuit breaker	Icu (kA)		Setting Ir	Switch-disconnector conditionnal short-circuit current and related making capacity									
	415 V	440 V		20/50	20/50	35/75	35/75	35/75	35/75	35/75	35/75	T	T
NS630bN	50	50	Ir ≤ 500	20/50	20/50	35/75	35/75	35/75	35/75	35/75	35/75	T	T
NS800N			Ir ≤ 630		20/50	35/75	35/75	35/75	35/75	35/75	35/75	T	T
NS1000N			Ir ≤ 800				35/75	35/75	35/75	35/75	35/75	T	T
NS1250N			Ir ≤ 1000					35/75	35/75	35/75	35/75	T	T
NS1600N			Ir ≤ 1250						35/75	35/75	35/75	T	T
			Ir ≤ 1600							35/75	35/75	T	T
NS630bH	70	65	Ir ≤ 500	20/50	20/50	35/75	35/75	35/75	35/75	35/75	50/105	50/105	
NS800H			Ir ≤ 630		20/50	35/75	35/75	35/75	35/75	35/75	50/105	50/105	
NS1000H			Ir ≤ 800				35/75	35/75	35/75	35/75	50/105	50/105	
NS1250H			Ir ≤ 1000					35/75	35/75	35/75	50/105	50/105	
NS1600H			Ir ≤ 1250						35/75	35/75	50/105	50/105	
			Ir ≤ 1600							35/75	50/105	50/105	
NS630bL	150	130	Ir ≤ 500	50/105	50/105	T	T	T	T	T	T	T	
NS800L			Ir ≤ 630		50/105	T	T	T	T	T	T	T	
NS1000L			Ir ≤ 800				T	T	T	T	T	T	
			Ir ≤ 1000					T	T	T	T	T	
NS630bLB	200	200	Ir ≤ 500	90/200	90/200	T	T	T	T	T	T	T	
NS800LB			Ir ≤ 630		90/200	T	T	T	T	T	T	T	
			Ir ≤ 800				T	T	T	T	T	T	
NS1600bN	70	65	Ir ≤ 1250						35/75	35/75	50/105	50/105	
NS2000N			Ir ≤ 1600							35/75	50/105	50/105	
NS2500N			Ir ≤ 2000								50/105	50/105	
NS3200N			Ir ≤ 2500									50/105	
NS1600bH	85	85	Ir ≤ 1250						35/75	35/75	50/105	50/105	
NS2000H			Ir ≤ 1600							35/75	50/105	50/105	
NS2500H			Ir ≤ 2000								50/105	50/105	
NS3200H			Ir ≤ 2500									50/105	
MTZ1 06H1	42	42	Ir ≤ 500	20/50	20/50	35/75	35/75	35/75	35/75	35/75	T	T	
MTZ1 08H1			Ir ≤ 630		20/50	35/75	35/75	35/75	35/75	35/75	T	T	
MTZ1 10H1			Ir ≤ 800				35/75	35/75	35/75	35/75	T	T	
MTZ1 12H1			Ir ≤ 1000					35/75	35/75	35/75	T	T	
MTZ1 16H1			Ir ≤ 1250						35/75	35/75	T	T	
			Ir ≤ 1600							35/75	T	T	
MTZ1 06H2	50	50	Ir ≤ 500	20/50	20/50	35/75	35/75	35/75	35/75	35/75	T	T	
MTZ1 08H2			Ir ≤ 630		20/50	35/75	35/75	35/75	35/75	35/75	T	T	
MTZ1 10H2			Ir ≤ 800				35/75	35/75	35/75	35/75	T	T	
MTZ1 12H2			Ir ≤ 1000					35/75	35/75	35/75	T	T	
MTZ1 16H2			Ir ≤ 1250						35/75	35/75	T	T	
			Ir ≤ 1600							35/75	T	T	
MTZ1 06H3	66	66	Ir ≤ 500	20/50	20/50	35/75	35/75	35/75	35/75	35/75	50/105	50/105	
MTZ1 08H3			Ir ≤ 630		20/50	35/75	35/75	35/75	35/75	35/75	50/105	50/105	
MTZ1 10H3			Ir ≤ 800				35/75	35/75	35/75	35/75	50/105	50/105	
MTZ1 12H3			Ir ≤ 1000					35/75	35/75	35/75	50/105	50/105	
MTZ1 16H3			Ir ≤ 1250						35/75	35/75	50/105	50/105	
			Ir ≤ 1600							35/75	50/105	50/105	
MTZ1 06L1	150	130	Ir ≤ 500	50/105	50/105	100/220	100/220	100/220	100/220	100/220	100/220	100/220	
MTZ1 08L1			Ir ≤ 630		50/105	100/220	100/220	100/220	100/220	100/220	100/220	100/220	
MTZ1 10L1			Ir ≤ 800			100/220	100/220	100/220	100/220	100/220	100/220	100/220	
			Ir ≤ 1000				100/220	100/220	100/220	100/220	100/220	100/220	

**T** : Protection of the switch-disconnector is ensured but combination not very relevant

**T** : Switch-disconnector is totally coordinated up to Icu of circuit breaker installed on supply side

**36/75** : Switch-disconnector is protected up to 36 kA rms / 75 kA

: Protection of the switch-disconnector is not ensured

# Switch-disconnector - Circuit breaker coordination

Upstream: Compact NS630b to 3200, Masterpact MTZ1

Downstream: Compact NS630b to 3200 NA

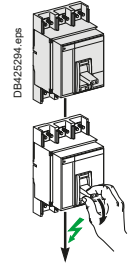

U<sub>e</sub> ≤ 440 V AC

Downstream	Switch-disconnector	NS630b NA	NS800 NA	NS1000 NA	NS1250 NA	NS1600 NA	NS1600b NA	NS2000 NA	NS2500 NA	NS3200 NA
	I <sub>th</sub> A 60°	630	800	1000	1250	1600	1600	2000	2500	3200
	I <sub>cw</sub> (kA)	25 (0.5s)	25 (0.5s)	25 (0.5s)	25 (0.5s)	25 (0.5s)	32 (3s)	32 (3s)	32 (3s)	32 (3s)
	I <sub>cm</sub> (kA)	52	52	52	52	52	135	135	135	135

Upstream Circuit breaker	I <sub>cu</sub> (kA)		Setting I <sub>r</sub>	Switch-disconnector conditional short-circuit current and related making capacity									
	415 V	440 V		NS630b NA	NS800 NA	NS1000 NA	NS1250 NA	NS1600 NA	NS1600b NA	NS2000 NA	NS2500 NA	NS3200 NA	
NS630bN	50	50	I <sub>r</sub> ≤ 630	T	T	T	T	T	T	T	T	T	
NS800N			I <sub>r</sub> ≤ 800		T	T	T	T	T	T	T	T	
NS1000N			I <sub>r</sub> ≤ 1000			T	T	T	T	T	T	T	
NS1250N			I <sub>r</sub> ≤ 1250				T	T	T	T	T	T	
NS1600N			I <sub>r</sub> ≤ 1600					T	T	T	T	T	
NS630bH	70	65	I <sub>r</sub> ≤ 630	T	T	T	T	T	T	T	T	T	
NS800H			I <sub>r</sub> ≤ 800		T	T	T	T	T	T	T	T	
NS1000H			I <sub>r</sub> ≤ 1000			T	T	T	T	T	T	T	
NS1250H			I <sub>r</sub> ≤ 1250				T	T	T	T	T	T	
NS1600H			I <sub>r</sub> ≤ 1600					T	T	T	T	T	
NS630bL	150	130	I <sub>r</sub> ≤ 630	T	T	T	T	T	T	T	T	T	
NS800L			I <sub>r</sub> ≤ 800		T	T	T	T	T	T	T	T	
NS1000L			I <sub>r</sub> ≤ 1000			T	T	T	T	T	T	T	
NS630bLB	200	200	I <sub>r</sub> ≤ 630	T	T	T	T	T	T	T	T	T	
NS800LB			I <sub>r</sub> ≤ 800		T	T	T	T	T	T	T	T	
NS1600bN	70	65	I <sub>r</sub> ≤ 1600						T	T	T	T	
NS2000N			I <sub>r</sub> ≤ 2000							T	T	T	
NS2500N			I <sub>r</sub> ≤ 2500								T	T	
NS3200N			I <sub>r</sub> ≤ 3200									T	
NS1600bH	85	85	I <sub>r</sub> ≤ 1600							T	T	T	
NS2000H			I <sub>r</sub> ≤ 2000								T	T	
NS2500H			I <sub>r</sub> ≤ 2500									T	
NS3200H			I <sub>r</sub> ≤ 3200										
MTZ1 06H1	42	42	I <sub>r</sub> ≤ 630	25/52	25/52	25/52	25/52	25/52	T	T	T	T	
MTZ1 08H1			I <sub>r</sub> ≤ 800		25/52	25/52	25/52	25/52	T	T	T	T	
MTZ1 10H1			I <sub>r</sub> ≤ 1000			25/52	25/52	25/52	T	T	T	T	
MTZ1 12H1			I <sub>r</sub> ≤ 1250				25/52	25/52	T	T	T	T	
MTZ1 16H1			I <sub>r</sub> ≤ 1600					25/52	T	T	T	T	
MTZ1 06H2	50	50	I <sub>r</sub> ≤ 630	25/52	25/52	25/52	25/52	25/52	T	T	T	T	
MTZ1 08H2			I <sub>r</sub> ≤ 800		25/52	25/52	25/52	25/52	T	T	T	T	
MTZ1 10H2			I <sub>r</sub> ≤ 1000			25/52	25/52	25/52	T	T	T	T	
MTZ1 12H2			I <sub>r</sub> ≤ 1250				25/52	25/52	T	T	T	T	
MTZ1 16H2			I <sub>r</sub> ≤ 1600					25/52	T	T	T	T	
MTZ1 06H3	66	66	I <sub>r</sub> ≤ 630	25/52	25/52	25/52	25/52	25/52	T	T	T	T	
MTZ1 08H3			I <sub>r</sub> ≤ 800		25/52	25/52	25/52	25/52	T	T	T	T	
MTZ1 10H3			I <sub>r</sub> ≤ 1000			25/52	25/52	25/52	T	T	T	T	
MTZ1 12H3			I <sub>r</sub> ≤ 1250				25/52	25/52	T	T	T	T	
MTZ1 16H3			I <sub>r</sub> ≤ 1600					25/52	T	T	T	T	
MTZ1 06L1	150	130	I <sub>r</sub> ≤ 630	T	T	T	T	T	T	T	T	T	
MTZ1 08L1			I <sub>r</sub> ≤ 800		T	T	T	T	T	T	T	T	
MTZ1 10L1			I <sub>r</sub> ≤ 1000			T	T	T	T	T	T	T	

- T : Protection of the switch-disconnector is ensured but combination not very relevant
- T : Switch-disconnector is totally coordinated up to I<sub>cu</sub> of circuit breaker installed on supply side
- 36/75 : Switch-disconnector is protected up to 36 kA rms / 75 kA
- : Protection of the switch-disconnector is not ensured

# Switch-disconnector - Circuit breaker coordination

Upstream: Masterpact MTZ2

Downstream: Compact INS/INV500 to 2500

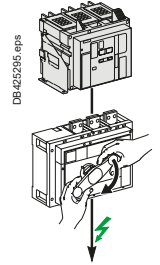

U<sub>e</sub> ≤ 440 V AC

Downstream	Switch-disconnector	INS500 INV500	INS630 INV630	INS630b INV630b	INS800 INV800	INS1000 INV1000	INS1250 INV1250	INS1600 INV1600	INS2000 INV2000	INS2500 INV2500
	I <sub>th</sub> A 60°	500	630	630	800	1000	1250	1600	2000	2500
	I <sub>cw</sub> (kA)	20	20	35	35	35	35	35	50	50
	I <sub>cm</sub> (kA)	50	50	75	75	75	75	75	105	105

Upstream Circuit breaker	I <sub>cu</sub> (kA)		Setting	Switch-disconnector conditionnal short-circuit current and related making capacity									
	415 V	440 V		I <sub>r</sub>									
MTZ2 08N1	42	42	I <sub>r</sub> ≤ 500	20/50	20/50	35/75	35/75	35/75	35/75	35/75	35/75	T	T
			I <sub>r</sub> ≤ 630		20/50	35/75	35/75	35/75	35/75	35/75	35/75	T	T
			I <sub>r</sub> ≤ 800			35/75	35/75	35/75	35/75	35/75	T	T	
			I <sub>r</sub> ≤ 1000				35/75	35/75	35/75	35/75	T	T	
			I <sub>r</sub> ≤ 1250					35/75	35/75	35/75	T	T	
MTZ2 16N1			I <sub>r</sub> ≤ 1600					35/75	35/75	35/75	T	T	
			I <sub>r</sub> ≤ 2000						35/75	35/75	T	T	
			I <sub>r</sub> ≤ 2500							35/75	35/75	T	T
MTZ2 08H1	66	66	I <sub>r</sub> ≤ 500	20/50	20/50	35/75	35/75	35/75	35/75	35/75	50/105	50/105	
			I <sub>r</sub> ≤ 630		20/50	35/75	35/75	35/75	35/75	35/75	50/105	50/105	
			I <sub>r</sub> ≤ 800			35/75	35/75	35/75	35/75	50/105	50/105		
			I <sub>r</sub> ≤ 1000				35/75	35/75	35/75	50/105	50/105		
			I <sub>r</sub> ≤ 1250					35/75	35/75	50/105	50/105		
			I <sub>r</sub> ≤ 1600						35/75	35/75	50/105	50/105	
			I <sub>r</sub> ≤ 2500							50/105	50/105		
MTZ2 08H2	100	100	I <sub>r</sub> ≤ 500	20/50	20/50	35/75	35/75	35/75	35/75	35/75	50/105	50/105	
			I <sub>r</sub> ≤ 630		20/50	35/75	35/75	35/75	35/75	35/75	50/105	50/105	
			I <sub>r</sub> ≤ 800			35/75	35/75	35/75	35/75	50/105	50/105		
			I <sub>r</sub> ≤ 1000				35/75	35/75	35/75	50/105	50/105		
			I <sub>r</sub> ≤ 1250					35/75	35/75	50/105	50/105		
			I <sub>r</sub> ≤ 1600						35/75	35/75	50/105	50/105	
			I <sub>r</sub> ≤ 2500							50/105	50/105		
MTZ2 20H3	150	150	I <sub>r</sub> ≤ 2000							50/105	50/105		
			I <sub>r</sub> ≤ 2500								50/105		

**T** : Protection of the switch-disconnector is ensured but combination not very relevant

**T** : Switch-disconnector is Totally coordinated up to I<sub>cu</sub> of circuit breaker installed on supply side

36/75 : Switch-disconnector is protected up to 36 kA rms / 75 kA

: Protection of the switch-disconnector is not ensured



# Switch-disconnector - Circuit breaker coordination

Upstream: Compact NS630b -1600, Masterpact MTZ1, MTZ2

Downstream: Masterpact MTZ1 HA, Masterpact MTZ2 NA

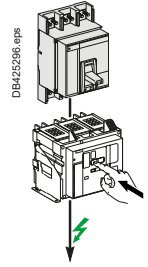

Ue ≤ 440 V AC

Downstream	Switch-disconnector	MTZ1	MTZ1	MTZ1	MTZ1	MTZ1	MTZ2	MTZ2	MTZ2	MTZ2
		06HA	08HA	10HA	12HA	16HA	08NA	10NA	12NA	16NA
	Ith A 60°	630	800	1000	1250	1600	800	1000	1250	1600
	Icw (kA)	36	36	36	36	36	42	42	42	42
	Icm (kA)	75	75	75	75	75	88	88	88	88

Upstream Circuit breaker	Icu (kA)		Setting I <sub>r</sub>	Switch-disconnector conditional short-circuit current and related making capacity								
	415 V	440 V		06HA	08HA	10HA	12HA	16HA	08NA	10NA	12NA	16NA
NS630bN	50	50	I <sub>r</sub> ≤ 630	T	T	T	T	T	T	T	T	T
NS800N			I <sub>r</sub> ≤ 800		T	T	T	T	T	T	T	T
NS1000N			I <sub>r</sub> ≤ 1000			T	T	T		T	T	T
NS1250N			I <sub>r</sub> ≤ 1250				T	T			T	T
NS1600N			I <sub>r</sub> ≤ 1600					T				T
NS630bH	70	65	I <sub>r</sub> ≤ 630	50/105	50/105	50/105	50/105	50/105	50/105	50/105	50/105	50/105
NS800H			I <sub>r</sub> ≤ 800		50/105	50/105	50/105	50/105	50/105	50/105	50/105	50/105
NS1000H			I <sub>r</sub> ≤ 1000			50/105	50/105	50/105		50/105	50/105	50/105
NS1250H			I <sub>r</sub> ≤ 1250				50/105	50/105			50/105	50/105
NS1600H			I <sub>r</sub> ≤ 1600					50/105				50/105
NS630bL	150	130	I <sub>r</sub> ≤ 630	T	T	T	T	T	T	T	T	T
NS800L			I <sub>r</sub> ≤ 800		T	T	T	T	T	T	T	T
NS1000L			I <sub>r</sub> ≤ 1000			T	T	T		T	T	T
NS630bLB	200	200	I <sub>r</sub> ≤ 630	T	T	T	T	T	T	T	T	T
NS800LB			I <sub>r</sub> ≤ 800		T	T	T	T	T	T	T	T
MTZ1 06H1	42	42	I <sub>r</sub> ≤ 630	36/75	36/75	36/75	36/75	36/75	42/88	42/88	42/88	42/88
MTZ1 08H1			I <sub>r</sub> ≤ 800		36/75	36/75	36/75	36/75	42/88	42/88	42/88	42/88
MTZ1 10H1			I <sub>r</sub> ≤ 1000			36/75	36/75	36/75		42/88	42/88	42/88
MTZ1 12H1			I <sub>r</sub> ≤ 1250				36/75	36/75			42/88	42/88
MTZ1 16H1			I <sub>r</sub> ≤ 1600					36/75				42/88
MTZ1 06H2	50	50	I <sub>r</sub> ≤ 630	36/75	36/75	36/75	36/75	36/75	42/88	42/88	42/88	42/88
MTZ1 08H2			I <sub>r</sub> ≤ 800		36/75	36/75	36/75	36/75	42/88	42/88	42/88	42/88
MTZ1 10H2			I <sub>r</sub> ≤ 1000			36/75	36/75	36/75		42/88	42/88	42/88
MTZ1 12H2			I <sub>r</sub> ≤ 1250				36/75	36/75			42/88	42/88
MTZ1 16H2			I <sub>r</sub> ≤ 1600					36/75				42/88
MTZ1 06H3	66	66	I <sub>r</sub> ≤ 630	36/75	36/75	36/75	36/75	36/75	42/88	42/88	42/88	42/88
MTZ1 08H3			I <sub>r</sub> ≤ 800		36/75	36/75	36/75	36/75	42/88	42/88	42/88	42/88
MTZ1 10H3			I <sub>r</sub> ≤ 1000			36/75	36/75	36/75		42/88	42/88	42/88
MTZ1 12H3			I <sub>r</sub> ≤ 1250				36/75	36/75			42/88	42/88
MTZ1 16H3			I <sub>r</sub> ≤ 1600					36/75				42/88
MTZ1 06L1	150	130	I <sub>r</sub> ≤ 630	T	T	T	T	T	T	T	T	T
MTZ1 08L1			I <sub>r</sub> ≤ 800		T	T	T	T	T	T	T	T
MTZ1 10L1			I <sub>r</sub> ≤ 1000			T	T	T		T	T	T
MTZ2 08N1	42	42	I <sub>r</sub> ≤ 800		36/75	36/75	36/75	36/75	42/88	42/88	42/88	42/88
MTZ2 10N1			I <sub>r</sub> ≤ 1000			36/75	36/75	36/75		42/88	42/88	42/88
MTZ2 12N1			I <sub>r</sub> ≤ 1250				36/75	36/75			42/88	42/88
MTZ2 16N1			I <sub>r</sub> ≤ 1600					36/75				42/88
MTZ2 20N1												
MTZ2 08H1	66	66	I <sub>r</sub> ≤ 800		36/75	36/75	36/75	36/75	42/88	42/88	42/88	42/88
MTZ2 10H1			I <sub>r</sub> ≤ 1000			36/75	36/75	36/75		42/88	42/88	42/88
MTZ2 12H1			I <sub>r</sub> ≤ 1250				36/75	36/75			42/88	42/88
MTZ2 16H1			I <sub>r</sub> ≤ 1600					36/75				42/88

- T : Protection of the switch-disconnector is ensured but combination not very relevant
- : Switch-disconnector is totally coordinated up to I<sub>cu</sub> of circuit breaker installed on supply side
- 36/75 : Switch-disconnector is protected up to 36 kA rms / 75 kA
- : Protection of the switch-disconnector is not ensured

# Switch-disconnector - Circuit breaker coordination

Upstream: Masterpact MTZ2, MTZ3

Downstream: Masterpact MTZ2 HA, MTZ3 HA

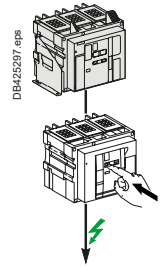

Ue ≤ 440 V AC

Downstream	Switch-disconnector	MTZ2 08 HA	MTZ2 10 HA	MTZ2 12 HA	MTZ2 16 HA	MTZ2 20 HA	MTZ2 25 HA	MTZ2 32 HA	MTZ2 40 HA	MTZ3 40 HA	MTZ3 50 HA	MTZ3 63 HA
	Ith A 60°	800	1000	1250	1600	2000	2500	3200	4000	4000	5000	6300
	Icw (kA)	66	66	66	66	66	66	66	66	85	85	85
	Icm (kA)	145	145	145	145	145	145	145	145	187	187	187

Upstream Circuit breaker	Icu (kA)		Setting Ir	Switch-disconnector conditionnal short-circuit current and related making capacity											
	415 V	440 V		08 HA	10 HA	12 HA	16 HA	20 HA	25 HA	32 HA	40 HA	40 HA	50 HA	63 HA	
MTZ2 08N1	42	42	Ir ≤ 800	T	T	T	T	T	T	T	T	T	T	T	
MTZ2 10N1			Ir ≤ 1000		T	T	T	T	T	T	T	T	T	T	
MTZ2 12N1			Ir ≤ 1250			T	T	T	T	T	T	T	T	T	
MTZ2 16N1			Ir ≤ 1600				T	T	T	T	T	T	T	T	
MTZ2 20N1			Ir ≤ 2000					T	T	T	T	T	T	T	
MTZ2 08H1	66	66	Ir ≤ 800	T	T	T	T	T	T	T	T	T	T	T	
MTZ2 10H1			Ir ≤ 1000		T	T	T	T	T	T	T	T	T	T	
MTZ2 12H1			Ir ≤ 1250			T	T	T	T	T	T	T	T	T	
MTZ2 16H1			Ir ≤ 1600				T	T	T	T	T	T	T	T	
MTZ2 20H1			Ir ≤ 2000					T	T	T	T	T	T	T	
MTZ2 25H1			Ir ≤ 2500						T	T	T	T	T	T	
MTZ2 32H1			Ir ≤ 3200							T	T	T	T	T	
MTZ2 40H1			Ir ≤ 4000								T	T	T	T	
MTZ3 40H1	100	100	Ir ≤ 4000								66/145	85/187	85/187	85/187	
MTZ3 50H1			Ir ≤ 5000										85/187	85/187	
MTZ3 63H1			Ir ≤ 6300											85/187	
MTZ2 08H2	100	100	Ir ≤ 800	66/145	66/145	66/145	66/145	66/145	66/145	66/145	66/145	85/187	85/187	85/187	
MTZ2 10H2			Ir ≤ 1000		66/145	66/145	66/145	66/145	66/145	66/145	66/145	85/187	85/187	85/187	
MTZ2 12H2			Ir ≤ 1250			66/145	66/145	66/145	66/145	66/145	66/145	85/187	85/187	85/187	
MTZ2 16H2			Ir ≤ 1600				66/145	66/145	66/145	66/145	66/145	85/187	85/187	85/187	
MTZ2 20H2			Ir ≤ 2000					66/145	66/145	66/145	66/145	85/187	85/187	85/187	
MTZ2 25H2			Ir ≤ 2500						66/145	66/145	66/145	85/187	85/187	85/187	
MTZ2 32H2			Ir ≤ 3200							66/145	66/145	85/187	85/187	85/187	
MTZ2 40H2			Ir ≤ 4000								66/145	85/187	85/187	85/187	
MTZ2 08L1	150	150	Ir ≤ 800	66/145	66/145	66/145	66/145	66/145	66/145	66/145	66/145	85/187	85/187	85/187	
MTZ2 10L1			Ir ≤ 1000		66/145	66/145	66/145	66/145	66/145	66/145	66/145	85/187	85/187	85/187	
MTZ2 12L1			Ir ≤ 1250			66/145	66/145	66/145	66/145	66/145	66/145	85/187	85/187	85/187	
MTZ2 16L1			Ir ≤ 1600				66/145	66/145	66/145	66/145	66/145	85/187	85/187	85/187	
MTZ2 20L1			Ir ≤ 2000					66/145	66/145	66/145	66/145	85/187	85/187	85/187	
MTZ2 20H3			Ir ≤ 2000					66/145	66/145	66/145	66/145	85/187	85/187	85/187	
MTZ2 25H3			Ir ≤ 2500						66/145	66/145	66/145	85/187	85/187	85/187	
MTZ2 32H3			Ir ≤ 3200							66/145	66/145	85/187	85/187	85/187	
MTZ2 40H3			Ir ≤ 4000								66/145	85/187	85/187	85/187	
MTZ3 40H2	150	150	Ir ≤ 4000								66/145	85/187	85/187	85/187	
MTZ3 50H2			Ir ≤ 5000										85/187	85/187	
MTZ3 63H2			Ir ≤ 6300											85/187	

T : Protection of the switch-disconnector is ensured but combination not very relevant

T : Switch-disconnector is totally coordinated up to Icu of circuit breaker installed on supply side

36/75 : Switch-disconnector is protected up to 36 kA rms / 75 kA

  : Protection of the switch-disconnector is not ensured

# Switch-disconnector - Circuit breaker coordination

Upstream: Masterpact MTZ2, Masterpact MTZ3

Downstream: Masterpact NW HF, NW HH

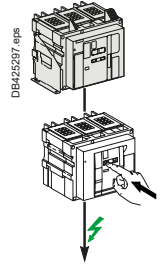

Ue ≤ 440 V AC

Downstream	Switch-disconnector	NW08	NW10	NW12	NW16	NW20	NW25	NW32	NW40	NW40b	NW50	NW63
		HF	HF	HF	HF	HF	HF	HF	HF	HH	HH	HH
	Ith A 60°	800	1000	1250	1600	2000	2500	3200	4000	4000	5000	6300
	Icw (kA)	85	85	85	85	85	85	85	85	100	100	100
	Icm (kA)	187	187	187	187	187	187	187	187	220	220	220

Upstream Circuit breaker	Icu (kA)		Setting I <sub>r</sub> ≤	Switch-disconnector conditionnal short-circuit current and related making capacity											
	415 V	440 V		NW08	NW10	NW12	NW16	NW20	NW25	NW32	NW40	NW40b	NW50	NW63	
MTZ2 08N1	42	42	I <sub>r</sub> ≤ 800	T	T	T	T	T	T	T	T	T	T	T	
			I <sub>r</sub> ≤ 1000		T	T	T	T	T	T	T	T	T	T	
			I <sub>r</sub> ≤ 1250			T	T	T	T	T	T	T	T	T	T
			I <sub>r</sub> ≤ 1600				T	T	T	T	T	T	T	T	T
			I <sub>r</sub> ≤ 2000					T	T	T	T	T	T	T	T
MTZ2 08H1	66	66	I <sub>r</sub> ≤ 800	T	T	T	T	T	T	T	T	T	T	T	
			I <sub>r</sub> ≤ 1000		T	T	T	T	T	T	T	T	T	T	
			I <sub>r</sub> ≤ 1250			T	T	T	T	T	T	T	T	T	
			I <sub>r</sub> ≤ 1600				T	T	T	T	T	T	T	T	
			I <sub>r</sub> ≤ 2000					T	T	T	T	T	T	T	
			I <sub>r</sub> ≤ 2500						T	T	T	T	T	T	
			I <sub>r</sub> ≤ 3200							T	T	T	T	T	
			I <sub>r</sub> ≤ 4000								T	T	T	T	
MTZ3 40H1	100	100	I <sub>r</sub> ≤ 2500						85/187	85/187	85/187	T	T	T	
			I <sub>r</sub> ≤ 3200							85/187	85/187	100/220	T	T	
			I <sub>r</sub> ≤ 4000									85/187	100/220	100/220	100/220
			I <sub>r</sub> ≤ 5000											100/220	100/220
MTZ2 08H2	100	100	I <sub>r</sub> ≤ 800	100/220	100/220	100/220	100/220	100/220	100/220	100/220	100/220	T	T	T	
			I <sub>r</sub> ≤ 1000		100/220	100/220	100/220	100/220	100/220	100/220	100/220	100/220	T	T	T
			I <sub>r</sub> ≤ 1250			100/220	100/220	100/220	100/220	100/220	100/220	100/220	T	T	T
			I <sub>r</sub> ≤ 1600				100/220	100/220	100/220	100/220	100/220	100/220	T	T	T
			I <sub>r</sub> ≤ 2000					100/220	100/220	100/220	100/220	100/220	T	T	T
			I <sub>r</sub> ≤ 2500						100/220	100/220	100/220	100/220	T	T	T
			I <sub>r</sub> ≤ 3200							100/220	100/220	100/220	T	T	T
			I <sub>r</sub> ≤ 4000								100/220	100/220	T	T	T
MTZ2 08L1	150	150	I <sub>r</sub> ≤ 800	100/220	100/220	100/220	100/220	100/220	100/220	100/220	100/220	100/220	100/220	100/220	
			I <sub>r</sub> ≤ 1000		100/220	100/220	100/220	100/220	100/220	100/220	100/220	100/220	100/220	100/220	
			I <sub>r</sub> ≤ 1250			100/220	100/220	100/220	100/220	100/220	100/220	100/220	100/220	100/220	
			I <sub>r</sub> ≤ 1600				100/220	100/220	100/220	100/220	100/220	100/220	100/220	100/220	
			I <sub>r</sub> ≤ 2000					100/220	100/220	100/220	100/220	100/220	100/220	100/220	
MTZ2 20H3	150	150	I <sub>r</sub> ≤ 2000					100/220	100/220	100/220	100/220	100/220	100/220		
			I <sub>r</sub> ≤ 2500						100/220	100/220	100/220	100/220	100/220		
			I <sub>r</sub> ≤ 3200							100/220	100/220	100/220	100/220		
			I <sub>r</sub> ≤ 4000								100/220	100/220	100/220		
MTZ3 40H2	150	150	I <sub>r</sub> ≤ 2500						100/220	100/220	100/220	100/220	100/220		
			I <sub>r</sub> ≤ 3200							100/220	100/220	100/220	100/220		
			I <sub>r</sub> ≤ 4000								100/220	100/220	100/220		
MTZ3 50H2	150	150	I <sub>r</sub> ≤ 5000									100/220	100/220		
			I <sub>r</sub> ≤ 6300										100/220	100/220	

- T : Protection of the switch-disconnector is ensured but combination not very relevant
- T : Switch-disconnector is totally coordinated up to I<sub>cu</sub> of circuit breaker installed on supply side
- 36/75 : Switch-disconnector is protected up to 36 kA rms / 75 kA
- : Protection of the switch-disconnector is not ensured

# Switch-disconnector - Circuit breaker coordination

Upstream: Compact NSXm, Compact NSX100 to 250

Downstream: Compact INS100 to 250, Compact INV100 to 250

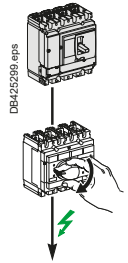

Ue: 500-525 V AC

Downstream	Switch-disconnector	INS100	INS250-100 INV100	INS125	INS160	INS250-160 INV160	INS250-200 INV200	INS250 INV250
		Ith A 60°	100	100	125	160	160	200
Icw (kA)		5.5	8.5	5.5	5.5	8.5	8.5	8.5
Icm (kA)		20	30	20	20	30	30	30

Upstream Circuit breaker	Icu (kA)		Ir	Switch-disconnector conditional short-circuit current and related making capacity						
	500 V	525 V		T	T	T	T	T	T	T
NSXm E/B TMD	8/10	-	Ir ≤ 40	T	T	T	T	T	T	T
			Ir ≤ 50	T	T	T	T	T	T	
			Ir ≤ 63	T	T	T	T	T	T	
NSXm F TMD	15	10	Ir ≤ 40	T	T	T	T	T	T	T
			Ir ≤ 50	T	T	T	T	T	T	
			Ir ≤ 63	T	T	T	T	T	T	
NSXm N TMD	25	15	Ir ≤ 40	T	T	T	T	T	T	T
			Ir ≤ 50	T	T	T	T	T	T	
			Ir ≤ 63	T	T	T	T	T	T	
NSXm H TMD	30	22	Ir ≤ 40	T	T	T	T	T	T	T
			Ir ≤ 50	T	T	T	T	T	T	
			Ir ≤ 63	T	T	T	T	T	T	
NSX100B NSX160B NSX250B TMD / TMG / Micrologic	15	-	Ir ≤ 100	T	T	T	T	T	T	T
			Ir ≤ 125			T	T	T	T	
			Ir ≤ 160				T	T	T	
			Ir ≤ 200					T	T	
			Ir ≤ 250						T	
NSX100F NSX160F NSX250F TMD / TMG / Micrologic	25	22	Ir ≤ 100	T	T	T	T	T	T	T
			Ir ≤ 125			T	T	T	T	
			Ir ≤ 160				T	T	T	
			Ir ≤ 200					T	T	
			Ir ≤ 250						T	
NSX100N NSX160N NSX250N TMD / TMG / Micrologic	36	35	Ir ≤ 100	22/46	T	22/46	T	T	T	T
			Ir ≤ 125			22/46	T	T	T	
			Ir ≤ 160				T	T	T	
			Ir ≤ 200					T	T	
			Ir ≤ 250						T	
NSX100H NSX160H NSX250H TMD / TMG / Micrologic	50	35	Ir ≤ 100	22/46	T	22/46	T	T	T	T
			Ir ≤ 125			22/46	T	T	T	
			Ir ≤ 160				T	T	T	
			Ir ≤ 200					T	T	
			Ir ≤ 250						T	
NSX100S NSX160S NSX250S TMD / TMG / Micrologic	65	40	Ir ≤ 100	22/46	T	22/46	T	T	T	T
			Ir ≤ 125			22/46	T	T	T	
			Ir ≤ 160				T	T	T	
			Ir ≤ 200					T	T	
			Ir ≤ 250						T	
NSX100L NSX160L NSX250L TMD / TMG / Micrologic	70	50	Ir ≤ 100	22/46	T	22/46	T	T	T	T
			Ir ≤ 125			22/46	T	T	T	
			Ir ≤ 160				T	T	T	
			Ir ≤ 200					T	T	
			Ir ≤ 250						T	
NSX100R NSX250R TMD / TMG / Micrologic	80	65	Ir ≤ 100	22/46	T	22/46	T	T	T	T
			Ir ≤ 125			22/46	T	T	T	
			Ir ≤ 160				T	T	T	
			Ir ≤ 200					T	T	
			Ir ≤ 250						T	

**T** : Protection of the switch-disconnector is ensured but combination not very relevant

**T** : Switch-disconnector is totally coordinated up to Icu of circuit breaker installed on supply side

**36/75** : Switch-disconnector is protected up to 36 kA rms / 75 kA

: Protection of the switch-disconnector is not ensured

# Switch-disconnector - Circuit breaker coordination

Upstream: Compact NSX400 to 630

Downstream: Compact INS/INV100 to 630

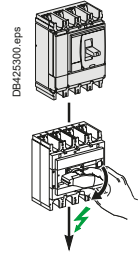

Ue: 500-525 V AC

Downstream	Switch-Disconnector	INS250-100 INV100	INS250-160 INV160	INS250-200 INV200	INS250 INV250	INS320 INV320	INS400 INV400	INS500 INV500	INS630 INV630	INS630b INV630b
		Ith A 60°	100	160	200	250	320	400	500	630
	Icw (kA)	8.5	8.5	8.5	8.5	20	20	20	20	35
	Icm (kA)	30	30	30	30	50	50	50	50	75

Upstream	Icu (kA)		Ir	Switch-disconnector conditionnal short-circuit current and related making capacity									
	500 V	525 V		INS250-100 INV100	INS250-160 INV160	INS250-200 INV200	INS250 INV250	INS320 INV320	INS400 INV400	INS500 INV500	INS630 INV630	INS630b INV630b	
NSX400F NSX630F Micrologic	25	20	Ir = 100 [1]	T	T	T	T	T	T	T	T	T	
			Ir ≤ 160		T	T	T	T	T	T	T	T	
			Ir ≤ 200			T	T	T	T	T	T	T	
			Ir ≤ 250				T	T	T	T	T	T	
			Ir ≤ 320					T	T	T	T	T	
			Ir ≤ 400						T	T	T	T	
			Ir ≤ 500							T	T	T	
NSX400N NSX630N Micrologic	30	22	Ir = 100 [1]	25/52	25/52	25/52	25/52	T	T	T	T	T	
			Ir ≤ 160		25/52	25/52	25/52	T	T	T	T	T	
			Ir ≤ 200			25/52	25/52	T	T	T	T	T	
			Ir ≤ 250				25/52	T	T	T	T	T	
			Ir ≤ 320					T	T	T	T	T	
			Ir ≤ 400						T	T	T	T	
			Ir ≤ 500							T	T	T	
NSX400H NSX630H Micrologic	50	35	Ir = 100 [1]	25/52	25/52	25/52	25/52	T	T	T	T	T	
			Ir ≤ 160		25/52	25/52	25/52	T	T	T	T	T	
			Ir ≤ 200			25/52	25/52	T	T	T	T	T	
			Ir ≤ 250				25/52	T	T	T	T	T	
			Ir ≤ 320					T	T	T	T	T	
			Ir ≤ 400						T	T	T	T	
			Ir ≤ 500							T	T	T	
NSX400S NSX630S Micrologic	65	40	Ir = 100 [1]	25/52	25/52	25/52	25/52	T	T	T	T	T	
			Ir ≤ 160		25/52	25/52	25/52	T	T	T	T	T	
			Ir ≤ 200			25/52	25/52	T	T	T	T	T	
			Ir ≤ 250				25/52	T	T	T	T	T	
			Ir ≤ 320					T	T	T	T	T	
			Ir ≤ 400						T	T	T	T	
			Ir ≤ 500							T	T	T	
NSX400L NSX630L Micrologic	70	50	Ir = 100 [1]	25/52	25/52	25/52	25/52	T	T	T	T	T	
			Ir ≤ 160		25/52	25/52	25/52	T	T	T	T	T	
			Ir ≤ 200			25/52	25/52	T	T	T	T	T	
			Ir ≤ 250				25/52	T	T	T	T	T	
			Ir ≤ 320					T	T	T	T	T	
			Ir ≤ 400						T	T	T	T	
			Ir ≤ 500							T	T	T	
NSX400R NSX630R Micrologic	80	65	Ir = 100 [1]	25/52	25/52	25/52	25/52	T	T	T	T	T	
			Ir ≤ 160		25/52	25/52	25/52	T	T	T	T	T	
			Ir ≤ 200			25/52	25/52	T	T	T	T	T	
			Ir ≤ 250				25/52	T	T	T	T	T	
			Ir ≤ 320					T	T	T	T	T	
			Ir ≤ 400						T	T	T	T	
			Ir ≤ 500							T	T	T	

- T : Protection of the switch-disconnector is ensured but combination not very relevant
- T : Switch-disconnector is totally coordinated up to Icu of circuit breaker installed on supply side
- 36/75 : Switch-disconnector is protected up to 36 kA rms / 75 kA
- : Protection of the switch-disconnector is not ensured

[1] NSX400 with Micrologic 250 A can be set down to 100 A.



# Switch-disconnector - Circuit breaker coordination

Upstream: Compact NS630b to 3200, Masterpact MTZ1/2

Downstream: Compact INS/INV500 to 2500

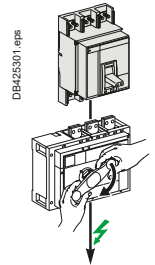

Ue: 500-525 V AC

Downstream	Switch-disconnector	INS500 INV500	INS630 INV630	INS630b INV630b	INS800 INV800	INS1000 INV1000	INS1250 INV1250	INS1600 INV1600	INS2000 INV2000	INS2500 INV2500
	Ith A 60°	500	630	630	800	1000	1250	1600	2000	2500
	Icw (kA)	20	20	35	35	35	35	35	50	50
	Icm (kA)	50	50	75	75	75	75	75	105	105

Upstream Circuit breaker	Icu (kA) 500-525 V	Ir	Switch-disconnector conditional short-circuit current and related making capacity								
			INS500 INV500	INS630 INV630	INS630b INV630b	INS800 INV800	INS1000 INV1000	INS1250 INV1250	INS1600 INV1600	INS2000 INV2000	INS2500 INV2500
NS630bN NS800N NS1000N NS1250N NS1600N	40	Ir ≤ 500	20/50	20/50	35/75	35/75	35/75	35/75	35/75	T	T
		Ir ≤ 630		20/50	35/75	35/75	35/75	35/75	35/75	T	T
		Ir ≤ 800				35/75	35/75	35/75	35/75	T	T
		Ir ≤ 1000					35/75	35/75	35/75	T	T
		Ir ≤ 1250						35/75	35/75	T	T
NS630bH NS800H NS1000H NS1250H NS1600H	50	Ir ≤ 500	20/50	20/50	35/75	35/75	35/75	35/75	35/75	T	T
		Ir ≤ 630		20/50	35/75	35/75	35/75	35/75	35/75	T	T
		Ir ≤ 800				35/75	35/75	35/75	35/75	T	T
		Ir ≤ 1000					35/75	35/75	35/75	T	T
		Ir ≤ 1250						35/75	35/75	T	T
NS630bL NS800L NS1000L	100	Ir ≤ 500	36/75	36/75	T	T	T	T	T	T	T
		Ir ≤ 630		36/75	T	T	T	T	T	T	T
		Ir ≤ 800				T	T	T	T	T	T
		Ir ≤ 1000					T	T	T	T	T
		Ir ≤ 1250						T	T	T	T
NS630bLB NS800LB	100	Ir ≤ 500	70/154	70/154	T	T	T	T	T	T	T
		Ir ≤ 630		70/154	T	T	T	T	T	T	T
		Ir ≤ 800				T	T	T	T	T	T
NS1600bN NS2000N NS2500N NS3200N	65	Ir ≤ 1250						35/75	35/75	50/105	50/105
		Ir ≤ 1600							35/75	50/105	50/105
		Ir ≤ 2000								50/105	50/105
		Ir ≤ 2500									50/105
MTZ1 06H1/H2 MTZ1 08H1/2 MTZ1 10H1/2 MTZ1 12H1/2 MTZ1 16H1/2	42	Ir ≤ 500	20/50	20/50	35/75	35/75	35/75	35/75	35/75	T	T
		Ir ≤ 630		20/50	35/75	35/75	35/75	35/75	35/75	T	T
		Ir ≤ 800				35/75	35/75	35/75	35/75	T	T
		Ir ≤ 1000					35/75	35/75	35/75	T	T
		Ir ≤ 1250						35/75	35/75	T	T
MTZ1 06L1 MTZ1 08L1 MTZ1 10L1	100	Ir ≤ 500	36/75	36/75	T	T	T	T	T	T	T
		Ir ≤ 630		36/75	T	T	T	T	T	T	T
		Ir ≤ 800				T	T	T	T	T	T
		Ir ≤ 1000					T	T	T	T	T
MTZ2 08N1 MTZ2 10N1 MTZ2 12N1 MTZ2 16N1 MTZ2 20N1	42	Ir ≤ 500	20/50	20/50	35/75	35/75	35/75	35/75	35/75	T	T
		Ir ≤ 630		20/50	35/75	35/75	35/75	35/75	35/75	T	T
		Ir ≤ 800				35/75	35/75	35/75	35/75	T	T
		Ir ≤ 1000					35/75	35/75	35/75	T	T
		Ir ≤ 1250						35/75	35/75	T	T
		Ir ≤ 1600							35/75	T	T
MTZ2 08 MTZ2 10 MTZ2 12 MTZ2 16 MTZ2 20 MTZ2 25 MTZ2 32 MTZ2 40	H1/H/H3/L1 66/85/130	Ir ≤ 500	20/50	20/50	35/75	35/75	35/75	35/75	35/75	50/105	50/105
		Ir ≤ 630		20/50	35/75	35/75	35/75	35/75	35/75	50/105	50/105
		Ir ≤ 800				35/75	35/75	35/75	35/75	50/105	50/105
		Ir ≤ 1000					35/75	35/75	35/75	50/105	50/105
		Ir ≤ 1250						35/75	35/75	50/105	50/105
		Ir ≤ 1600							35/75	50/105	50/105
		Ir ≤ 2000								50/105	50/105
		Ir ≤ 2500									50/105

**T** : Protection of the switch-disconnector is ensured but combination not very relevant

**T** : Switch-disconnector is totally coordinated up to Icu of circuit breaker installed on supply side

36/75 : Switch-disconnector is protected up to 36 kA rms / 75 kA

: Protection of the switch-disconnector is not ensured

# Switch-disconnector - Circuit breaker coordination

Upstream: Compact NSXm, Compact NSX100 to 250

Downstream: Compact INS100 to 250, Compact INV100 to 250

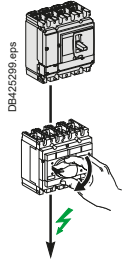

Ue: 690 V AC

Downstream	Switch-disconnector	INS100	INS250-100 INV100	INS125	INS160	INS250-160 INV160	INS250-200 INV200	INS250 INV250
	Ith A 60°	100	100	125	160	160	200	200
	Icw (kA)	5.5	8.5	5.5	5.5	8.5	8.5	8.5
	Icm (kA)	20	30	20	20	30	30	30

Upstream Circuit breaker	Icu (kA) 690 V	Ir	Switch-disconnector conditional short-circuit current and related making capacity						
NSXm N TMD	10	Ir ≤ 40	T	T	T	T	T	T	T
		Ir ≤ 50	T	T	T	T	T	T	T
		Ir ≤ 63	T	T	T	T	T	T	T
NSXm H TMD	10	Ir ≤ 40	T	T	T	T	T	T	T
		Ir ≤ 50	T	T	T	T	T	T	T
		Ir ≤ 63	T	T	T	T	T	T	T
NSX100F NSX160F NSX250F TMD / TMG / Micrologic	8	Ir ≤ 100	T	T	T	T	T	T	T
		Ir ≤ 125			T	T	T	T	T
		Ir ≤ 160				T	T	T	T
		Ir ≤ 200					T	T	T
		Ir ≤ 250						T	T
NSX100N NSX160N NSX250N TMD / TMG / Micrologic	10	Ir ≤ 100	T	T	T	T	T	T	T
		Ir ≤ 125			T	T	T	T	T
		Ir ≤ 160				T	T	T	T
		Ir ≤ 200					T	T	T
		Ir ≤ 250						T	T
NSX100H NSX160H NSX250H TMD / TMG / Micrologic	10	Ir ≤ 100	T	T	T	T	T	T	T
		Ir ≤ 125			T	T	T	T	T
		Ir ≤ 160				T	T	T	T
		Ir ≤ 200					T	T	T
		Ir ≤ 250						T	T
NSX100S NSX160S NSX250S TMD / TMG / Micrologic	15	Ir ≤ 100	T	T	T	T	T	T	T
		Ir ≤ 125			T	T	T	T	T
		Ir ≤ 160				T	T	T	T
		Ir ≤ 200					T	T	T
		Ir ≤ 250						T	T
NSX100L NSX160L NSX250L TMD / TMG / Micrologic	20	Ir ≤ 100	T	T	T	T	T	T	T
		Ir ≤ 125			T	T	T	T	T
		Ir ≤ 160				T	T	T	T
		Ir ≤ 200					T	T	T
		Ir ≤ 250						T	T
NSX100R NSX250R TMD / TMG / Micrologic	45	Ir ≤ 100	20/40	T	20/40	20/40	T	T	T
		Ir ≤ 125			20/40	20/40	T	T	T
		Ir ≤ 160				20/40	T	T	T
		Ir ≤ 200						T	T
		Ir ≤ 250							T

- T : Protection of the switch-disconnector is ensured but combination not very relevant
- T : Switch-disconnector is totally coordinated up to Icu of circuit breaker installed on supply side
- 36/75 : Switch-disconnector is protected up to 36 kA rms / 75 kA
- : Protection of the switch-disconnector is not ensured

# Switch-disconnector - Circuit breaker coordination

Upstream: Compact NSX400 to 630

Downstream: Compact INS/INV500 to 2500

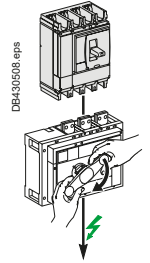

Ue: 690 V AC

Downstream	Switch-disconnector	INS500 INV500	INS630 INV630	INS630b INV630b	INS800 INV800	INS1000 INV1000	INS1250 INV1250	INS1600 INV1600	INS2000 INV2000	INS2500 INV2500
	Ith A 60°	630	630	630	800	1000	1250	1600	2000	2500
	Icw (kA)	20	20	35	35	35	35	35	50	50
	Icm (kA)	50	50	75	75	75	75	75	105	105

Upstream Circuit breaker	Icu (kA) 690 V	Ir	Switch-disconnector conditional short-circuit current and related making capacity									
			INS500 INV500	INS630 INV630	INS630b INV630b	INS800 INV800	INS1000 INV1000	INS1250 INV1250	INS1600 INV1600	INS2000 INV2000	INS2500 INV2500	
NSX400F NSX630F Micrologic	10	Ir = 100 <sup>[1]</sup>	T	T	T	T	T	T	T	T	T	
		Ir ≤ 160		T	T	T	T	T	T	T	T	
		Ir ≤ 200			T	T	T	T	T	T	T	
		Ir ≤ 250				T	T	T	T	T	T	
		Ir ≤ 320					T	T	T	T	T	
		Ir ≤ 400						T	T	T	T	
		Ir ≤ 500							T	T	T	
NSX400N NSX630N Micrologic	10	Ir = 100 <sup>[1]</sup>	T	T	T	T	T	T	T	T	T	
		Ir ≤ 160		T	T	T	T	T	T	T	T	
		Ir ≤ 200			T	T	T	T	T	T	T	
		Ir ≤ 250				T	T	T	T	T	T	
		Ir ≤ 320					T	T	T	T	T	
		Ir ≤ 400						T	T	T	T	
		Ir ≤ 500							T	T	T	
NSX400H NSX630H Micrologic	20	Ir = 100 <sup>[1]</sup>	T	T	T	T	T	T	T	T	T	
		Ir ≤ 160		T	T	T	T	T	T	T	T	
		Ir ≤ 200			T	T	T	T	T	T	T	
		Ir ≤ 250				T	T	T	T	T	T	
		Ir ≤ 320					T	T	T	T	T	
		Ir ≤ 400						T	T	T	T	
		Ir ≤ 500							T	T	T	
NSX400S NSX630S Micrologic	25	Ir = 100 <sup>[1]</sup>	T	T	T	T	T	T	T	T	T	
		Ir ≤ 160		T	T	T	T	T	T	T	T	
		Ir ≤ 200			T	T	T	T	T	T	T	
		Ir ≤ 250				T	T	T	T	T	T	
		Ir ≤ 320					T	T	T	T	T	
		Ir ≤ 400						T	T	T	T	
		Ir ≤ 500							T	T	T	
NSX400L NSX630L Micrologic	35	Ir = 100 <sup>[1]</sup>	25/52	25/52	25/52	25/52	T	T	T	T	T	
		Ir ≤ 160		25/52	25/52	25/52	T	T	T	T	T	
		Ir ≤ 200			25/52	25/52	T	T	T	T	T	
		Ir ≤ 250				25/52	T	T	T	T	T	
		Ir ≤ 320					T	T	T	T	T	
		Ir ≤ 400						T	T	T	T	
		Ir ≤ 500							T	T	T	
NSX400R NSX630R Micrologic	45	Ir = 100 <sup>[1]</sup>	25/52	25/52	25/52	25/52	T	T	T	T	T	
		Ir ≤ 160		25/52	25/52	25/52	T	T	T	T	T	
		Ir ≤ 200			25/52	25/52	T	T	T	T	T	
		Ir ≤ 250				25/52	T	T	T	T	T	
		Ir ≤ 320					T	T	T	T	T	
		Ir ≤ 400						T	T	T	T	
		Ir ≤ 500							T	T	T	

**T** : Protection of the switch-disconnector is ensured but combination not very relevant

**T** : Switch-disconnector is totally coordinated up to Icu of circuit breaker installed on supply side

36/75 : Switch-disconnector is protected up to 36 kA rms / 75 kA

: Protection of the switch-disconnector is not ensured

[1] NSX400 with Micrologic 250 A can be set down to 100 A.

# Switch-disconnector - Circuit breaker coordination

Upstream: Compact NS630b to 3200, Masterpact MTZ1/2

Downstream: Compact INS/INV500 to 2500

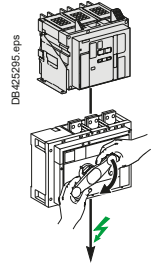

Ue: 690 V AC

Downstream	Switch-disconnector	INS500 INV500	INS630 INV630	INS630b INV630b	INS800 INV800	INS1000 INV1000	INS1250 INV1250	INS1600 INV1600	INS2000 INV2000	INS2500 INV2500
	Ith A 60°	630	630	630	800	1000	1250	1600	2000	2500
	Icw (kA)	20	20	35	35	35	35	35	50	50
	Icm (kA)	50	50	75	75	75	75	75	105	105

Upstream Circuit breaker	Icu (kA) 690 V	Ir	Switch-disconnector conditional short-circuit current and related making capacity								
			INS500 INV500	INS630 INV630	INS630b INV630b	INS800 INV800	INS1000 INV1000	INS1250 INV1250	INS1600 INV1600	INS2000 INV2000	INS2500 INV2500
NS630bN NS800N NS1000N NS1250N NS1600N	30	Ir ≤ 500	20/50	20/50	35/75	35/75	35/75	35/75	35/75	T	T
		Ir ≤ 630		20/50	35/75	35/75	35/75	35/75	35/75	T	T
		Ir ≤ 800				35/75	35/75	35/75	35/75	T	T
		Ir ≤ 1000					35/75	35/75	35/75	T	T
		Ir ≤ 1250						35/75	35/75	T	T
		Ir ≤ 1600							35/75	T	T
NS630bH NS800H NS1000H NS1250H NS1600H	42	Ir ≤ 500	20/50	20/50	35/75	35/75	35/75	35/75	50/105	50/105	
		Ir ≤ 630		20/50	35/75	35/75	35/75	35/75	50/105	50/105	
		Ir ≤ 800				35/75	35/75	35/75	50/105	50/105	
		Ir ≤ 1000					35/75	35/75	50/105	50/105	
		Ir ≤ 1250						35/75	50/105	50/105	
		Ir ≤ 1600							35/75	50/105	50/105
NS630bLB NS800LB	75	Ir ≤ 500	70/154	70/154	T	T	T	T	T	T	
		Ir ≤ 630		70/154	T	T	T	T	T	T	
		Ir ≤ 800			T	T	T	T	T	T	
NS1600bN NS2000N NS2500N NS3200N	65	Ir ≤ 1250						35/75	35/75	50/105	50/105
		Ir ≤ 1600							35/75	50/105	50/105
		Ir ≤ 2000								50/105	50/105
		Ir ≤ 2500									50/105
MTZ1 06H1/H2 MTZ1 08H1/2 MTZ1 10H1/2 MTZ1 12H1/2 MTZ1 16H1/2	42	Ir ≤ 500	20/50	20/50	35/75	35/75	35/75	35/75	35/75	T	T
		Ir ≤ 630		20/50	35/75	35/75	35/75	35/75	35/75	T	T
		Ir ≤ 800				35/75	35/75	35/75	35/75	T	T
		Ir ≤ 1000					35/75	35/75	35/75	T	T
		Ir ≤ 1250						35/75	35/75	T	T
		Ir ≤ 1600							35/75	T	T
MTZ1 06L1 MTZ1 08L1 MTZ1 10L1	25	Ir ≤ 500	T	T	T	T	T	T	T	T	T
		Ir ≤ 630		T	T	T	T	T	T	T	T
		Ir ≤ 800			T	T	T	T	T	T	T
		Ir ≤ 1000				T	T	T	T	T	T
MTZ2 08N1 MTZ2 10N1 MTZ2 12N1 MTZ2 16N1 MTZ2 20N1	42	Ir ≤ 500	20/50	20/50	35/75	35/75	35/75	35/75	35/75	T	T
		Ir ≤ 630		20/50	35/75	35/75	35/75	35/75	35/75	T	T
		Ir ≤ 800				35/75	35/75	35/75	35/75	T	T
		Ir ≤ 1000					35/75	35/75	35/75	T	T
		Ir ≤ 1250						35/75	35/75	T	T
		Ir ≤ 1600							35/75	T	T
MTZ2 08 MTZ2 10 MTZ2 12 MTZ2 16 MTZ2 20 MTZ2 25 MTZ2 32 MTZ2 40	H1/H2/H3/L1 66/85/100/100	Ir ≤ 500	20/50	20/50	35/75	35/75	35/75	35/75	35/75	50/105	50/105
		Ir ≤ 630		20/50	35/75	35/75	35/75	35/75	35/75	50/105	50/105
		Ir ≤ 800				35/75	35/75	35/75	35/75	50/105	50/105
		Ir ≤ 1000					35/75	35/75	35/75	50/105	50/105
		Ir ≤ 1250						35/75	35/75	50/105	50/105
		Ir ≤ 1600							35/75	50/105	50/105
		Ir ≤ 2000								50/105	50/105
		Ir ≤ 2500									50/105

- T : Protection of the switch-disconnector is ensured but combination not very relevant
- T : Switch-disconnector is totally coordinated up to Icu of circuit breaker installed on supply side
- 36/75 : Switch-disconnector is protected up to 36 kA rms / 75 kA
- : Protection of the switch-disconnector is not ensured

# Switch-disconnector - Circuit breaker coordination

Upstream: Compact NSX100 to 630

Downstream: Compact NSX100NA to 630NA

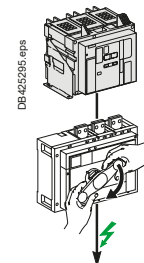

Ue: 500-525 V AC

Ue: 690 V AC

Downstream	Switch-disconnector	NSX100NA	NSX160NA	NSX250NA	NSX400NA	NSX630NA
	I <sub>th</sub> A 60°	100	160	250	400	630
	I <sub>cw</sub> (kA)	1.8	2.5	3.5	5	6
	I <sub>cm</sub> (kA)	2.6	3.6	4.9	7.1	8.5

Upstream Circuit breaker	I <sub>cu</sub> (kA)			I <sub>r</sub>	Switch-disconnector conditional short-circuit current and related making capacity				
	500 V	525 V	690 V						
NSX100B NSX160B NSX250B TMD / TMG / Micrologic	15	-	-	I <sub>r</sub> ≤ 50	T	T	T	T	T
				I <sub>r</sub> ≤ 100	T	T	T	T	T
				I <sub>r</sub> ≤ 160		T	T	T	T
				I <sub>r</sub> ≤ 250			T	T	T
NSX100F NSX160F NSX250F TMD / TMG / Micrologic	25	22	8	I <sub>r</sub> ≤ 50	T	T	T	T	T
				I <sub>r</sub> ≤ 100	T	T	T	T	T
				I <sub>r</sub> ≤ 160		T	T	T	T
				I <sub>r</sub> ≤ 250			T	T	T
NSX400F NSX630F Micrologic	25	20	10	I <sub>r</sub> = 100 [1]	T	T	T	T	T
				I <sub>r</sub> ≤ 160		T	T	T	T
				I <sub>r</sub> ≤ 250			T	T	T
				I <sub>r</sub> ≤ 400				T	T
NSX100N NSX160N NSX250N TMD / TMG / Micrologic	36	35	10	I <sub>r</sub> ≤ 50	T	T	T	T	T
				I <sub>r</sub> ≤ 100	T	T	T	T	T
				I <sub>r</sub> ≤ 160		T	T	T	T
				I <sub>r</sub> ≤ 250			T	T	T
NSX400N NSX630N Micrologic	30	22	10	I <sub>r</sub> = 100 [1]	T	T	T	T	T
				I <sub>r</sub> ≤ 160		T	T	T	T
				I <sub>r</sub> ≤ 250			T	T	T
				I <sub>r</sub> ≤ 400				T	T
NSX100H NSX160H NSX250H TMD / TMG / Micrologic	50	35	10	I <sub>r</sub> ≤ 50	T	T	T	T	T
				I <sub>r</sub> ≤ 100	T	T	T	T	T
				I <sub>r</sub> ≤ 160		T	T	T	T
				I <sub>r</sub> ≤ 250			T	T	T
NSX400H NSX630H Micrologic	50	35	20	I <sub>r</sub> = 100 [1]	T	T	T	T	T
				I <sub>r</sub> ≤ 160		T	T	T	T
				I <sub>r</sub> ≤ 250			T	T	T
				I <sub>r</sub> ≤ 400				T	T
NSX100S NSX160S NSX250S TMD / TMG / Micrologic	65	40	15	I <sub>r</sub> ≤ 50	T	T	T	T	T
				I <sub>r</sub> ≤ 100	T	T	T	T	T
				I <sub>r</sub> ≤ 160		T	T	T	T
				I <sub>r</sub> ≤ 250			T	T	T
NSX400S NSX630S Micrologic	65	40	25	I <sub>r</sub> = 100 [1]	T	T	T	T	T
				I <sub>r</sub> ≤ 160		T	T	T	T
				I <sub>r</sub> ≤ 250			T	T	T
				I <sub>r</sub> ≤ 400				T	T
NSX100L NSX160L NSX250L TMD / TMG / Micrologic	70	50	20	I <sub>r</sub> ≤ 50	T	T	T	T	T
				I <sub>r</sub> ≤ 100	T	T	T	T	T
				I <sub>r</sub> ≤ 160		T	T	T	T
				I <sub>r</sub> ≤ 250			T	T	T
NSX400L NSX630L Micrologic	70	50	35	I <sub>r</sub> = 100 [1]	T	T	T	T	T
				I <sub>r</sub> ≤ 160		T	T	T	T
				I <sub>r</sub> ≤ 250			T	T	T
				I <sub>r</sub> ≤ 400				T	T
				I <sub>r</sub> ≤ 630					T

**T** : Protection of the switch-disconnector is ensured but combination not very relevant

**T** : Switch-disconnector is totally coordinated up to I<sub>cu</sub> of circuit breaker installed on supply side

: Protection of the switch-disconnector is not ensured

[1] NSX400 with Micrologic 250 A can be set down to 100 A.

# Switch-disconnector - Circuit breaker coordination

Upstream: Compact NS630b to 3200, Masterpact MTZ1

Downstream: Compact NS630b to 3200 NA

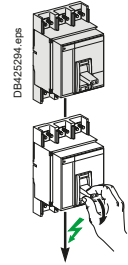

Ue: 500-525 V AC

Ue: 690 V AC

Downstream	Switch-disconnector	NS630b NA	NS800 NA	NS1000 NA	NS1250 NA	NS1600 NA	NS1600b NA	NS2000 NA	NS2500 NA	NS3200 NA
	Ith A 60°	630	800	1000	1250	1600	1600	2000	2500	3200
	Icw (kA)	25 (0.5s)	25 (0.5s)	25 (0.5s)	25 (0.5s)	25 (0.5s)	32 (3s)	32 (3s)	32 (3s)	32 (3s)
	Icm (kA)	52	52	52	52	52	135	135	135	135

Upstream	Icu (kA)	Setting	Switch-disconnector conditional short-circuit current and related making capacity										
Circuit breaker	500-525 V	690 V	Ir										
NS630bN	40	30	Ir ≤ 630	T	T	T	T	T	T	T	T	T	T
			Ir ≤ 800		T	T	T	T	T	T	T	T	T
			Ir ≤ 1000			T	T	T	T	T	T	T	T
			Ir ≤ 1250				T	T	T	T	T	T	T
NS800N	50	42	Ir ≤ 630	T	T	T	T	T	T	T	T	T	
			Ir ≤ 800		T	T	T	T	T	T	T	T	
			Ir ≤ 1000			T	T	T	T	T	T	T	
			Ir ≤ 1250				T	T	T	T	T	T	
NS1000N	100	-	Ir ≤ 630	T	T	T	T	T	T	T	T	T	
			Ir ≤ 800		T	T	T	T	T	T	T	T	
			Ir ≤ 1000			T	T	T	T	T	T	T	
			Ir ≤ 1250				T	T	T	T	T	T	
NS1250N	100	75	Ir ≤ 630	T	T	T	T	T	T	T	T	T	
			Ir ≤ 800		T	T	T	T	T	T	T	T	
			Ir ≤ 1000			T	T	T	T	T	T	T	
			Ir ≤ 1250				T	T	T	T	T	T	
NS1600N	65	65	Ir ≤ 1600						T	T	T	T	
			Ir ≤ 2000							T	T	T	
			Ir ≤ 2500								T	T	
			Ir ≤ 3200									T	
MTZ1 06H1	42	42	Ir ≤ 630	25/52	25/52	25/52	25/52	25/52	T	T	T	T	
			Ir ≤ 800		25/52	25/52	25/52	25/52	T	T	T	T	
			Ir ≤ 1000			25/52	25/52	25/52	T	T	T	T	
			Ir ≤ 1250				25/52	25/52	T	T	T	T	
MTZ1 12H1	100	25	Ir ≤ 630	T	T	T	T	T	T	T	T	T	
			Ir ≤ 800		T	T	T	T	T	T	T	T	
			Ir ≤ 1000			T	T	T	T	T	T	T	
			Ir ≤ 1600				T	T	T	T	T	T	

- T : Protection of the switch-disconnector is ensured but combination not very relevant
- T : Switch-disconnector is totally coordinated up to Icu of circuit breaker installed on supply side
- 36/75 : Switch-disconnector is protected up to 36 kA rms / 75 kA
- : Protection of the switch-disconnector is not ensured

# Switch-disconnector - Circuit breaker coordination

Upstream: Compact NS630b to 1600, Masterpact MTZ1, MTZ2

Downstream: Masterpact MTZ1 HA, Masterpact MTZ2 NA

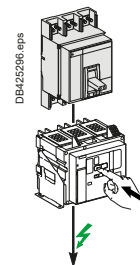

Ue: 500-525 V AC

Ue: 690 V AC

Downstream	Switch-disconnector	MTZ1 06HA	MTZ1 08HA	MTZ1 10HA	MTZ1 12HA	MTZ1 16HA	MTZ2 08NA	MTZ2 10NA	MTZ2 12NA	MTZ2 16NA
	Ith A 60°	630	800	1000	1250	1600	800	1000	1250	1600
	Icw (kA)	36	36	36	36	36	42	42	42	42
	Icm (kA)	75	75	75	75	75	88	88	88	88

Upstream	Icu (kA)	Setting	Switch-disconnector conditional short-circuit current and related making capacity																	
Circuit breaker	500-525 V	690 V	Ir																	
NS630bN	40	30	Ir ≤ 630	T	T	T	T	T	T	T	T	T	T	T	T	T	T	T	T	T
NS800N			Ir ≤ 800		T	T	T	T	T	T	T	T	T	T	T	T	T	T	T	T
NS1000N			Ir ≤ 1000			T	T	T	T		T	T	T	T	T	T	T	T	T	T
NS1250N			Ir ≤ 1250				T	T				T	T	T	T	T	T	T	T	T
NS1600N			Ir ≤ 1600					T												T
NS630bH	50	42	Ir ≤ 630	T	T	T	T	T	T	T	T	T	T	T	T	T	T	T	T	T
NS800H			Ir ≤ 800		T	T	T	T	T	T	T	T	T	T	T	T	T	T	T	T
NS1000H			Ir ≤ 1000			T	T	T	T		T	T	T	T	T	T	T	T	T	T
NS1250H			Ir ≤ 1250				T	T												T
NS1600H			Ir ≤ 1600					T												T
NS630bL	100	-	Ir ≤ 630	T	T	T	T	T	T	T	T	T	T	T	T	T	T	T	T	T
NS800L			Ir ≤ 800		T	T	T	T	T	T	T	T	T	T	T	T	T	T	T	T
NS1000L			Ir ≤ 1000			T	T	T			T	T	T	T	T	T	T	T	T	T
NS630bLB	100	75	Ir ≤ 630	T	T	T	T	T	T	T	T	T	T	T	T	T	T	T	T	T
NS800LB			Ir ≤ 800		T	T	T	T	T	T	T	T	T	T	T	T	T	T	T	T
MTZ1 06H1/2	42	42	Ir ≤ 630	36/75	36/75	36/75	36/75	36/75	36/75	T	T	T	T	T	T	T	T	T	T	T
MTZ1 08H1/2			Ir ≤ 800		36/75	36/75	36/75	36/75	36/75	T	T	T	T	T	T	T	T	T	T	T
MTZ1 10H1/2			Ir ≤ 1000			36/75	36/75	36/75	36/75		T	T	T	T	T	T	T	T	T	T
MTZ1 12H1/2			Ir ≤ 1250				36/75	36/75	36/75											T
MTZ1 16H1/2			Ir ≤ 1600					36/75	36/75											T
MTZ1 06L1	100	25	Ir ≤ 630	T	T	T	T	T	T	T	T	T	T	T	T	T	T	T	T	T
MTZ1 08L1			Ir ≤ 800		T	T	T	T	T	T	T	T	T	T	T	T	T	T	T	T
MTZ1 10L1			Ir ≤ 1000			T	T	T			T	T	T	T	T	T	T	T	T	T
MTZ2 08N1	42	42	Ir ≤ 800		36/75	36/75	36/75	36/75	36/75	T	T	T	T	T	T	T	T	T	T	T
MTZ2 10N1			Ir ≤ 1000			36/75	36/75	36/75	36/75		T	T	T	T	T	T	T	T	T	T
MTZ2 12N1			Ir ≤ 1250				36/75	36/75	36/75				T	T	T	T	T	T	T	T
MTZ2 16N1			Ir ≤ 1600					36/75	36/75											T
MTZ2 20N1																				
MTZ2 08H1	66	66	Ir ≤ 800		36/75	36/75	36/75	36/75	36/75	42/88	42/88	42/88	42/88	42/88	42/88	42/88	42/88	42/88	42/88	42/88
MTZ2 10H1			Ir ≤ 1000			36/75	36/75	36/75	36/75			42/88	42/88	42/88	42/88	42/88	42/88	42/88	42/88	42/88
MTZ2 12H1			Ir ≤ 1250				36/75	36/75	36/75				42/88	42/88	42/88	42/88	42/88	42/88	42/88	42/88
MTZ2 16H1			Ir ≤ 1600					36/75	36/75											42/88
MTZ2 20H1																				

- T : Protection of the switch-disconnector is ensured but combination not very relevant
- T : Switch-disconnector is totally coordinated up to Icu of circuit breaker installed on supply side
- 36/75 : Switch-disconnector is protected up to 36 kA rms / 75 kA
- : Protection of the switch-disconnector is not ensured

# Switch-disconnector - Circuit breaker coordination

Upstream: Masterpact MTZ2, MTZ3

Downstream: Masterpact MTZ2 HA, MTZ3 HA

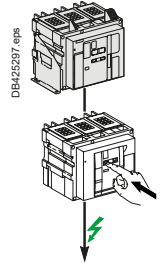

Ue: 500-525 V AC

Ue: 690 V AC

Downstream	Switch-disconnector	MTZ2 08 HA	MTZ2 10 HA	MTZ2 12 HA	MTZ2 16 HA	MTZ2 20 HA	MTZ2 25 HA	MTZ2 32 HA	MTZ2 40 HA	MTZ3 40 HA	MTZ3 50 HA	MTZ3 63 HA
	Ith A 60°		800	1000	1250	1600	2000	2500	3200	4000	4000	5000
Icw (kA)		66	66	66	66	66	66	66	66	85	85	85
Icm (kA)		145	145	145	145	145	145	145	145	187	187	187

Upstream Circuit breaker	Icu (kA)		Setting I <sub>r</sub>	Switch-disconnector conditional short-circuit current and related making capacity										
	500-525 V	690 V		MTZ2 08 HA	MTZ2 10 HA	MTZ2 12 HA	MTZ2 16 HA	MTZ2 20 HA	MTZ2 25 HA	MTZ2 32 HA	MTZ2 40 HA	MTZ3 40 HA	MTZ3 50 HA	MTZ3 63 HA
MTZ2 08N1	42	42	I <sub>r</sub> ≤ 800	T	T	T	T	T	T	T	T	T	T	
MTZ2 10N1			I <sub>r</sub> ≤ 1000		T	T	T	T	T	T	T	T	T	
MTZ2 12N1			I <sub>r</sub> ≤ 1250			T	T	T	T	T	T	T	T	
MTZ2 16N1			I <sub>r</sub> ≤ 1600				T	T	T	T	T	T	T	
MTZ2 20N1			I <sub>r</sub> ≤ 2000					T	T	T	T	T	T	
MTZ2 08H1	66	66	I <sub>r</sub> ≤ 800	T	T	T	T	T	T	T	T	T	T	
MTZ2 10H1			I <sub>r</sub> ≤ 1000		T	T	T	T	T	T	T	T	T	
MTZ2 12H1			I <sub>r</sub> ≤ 1250			T	T	T	T	T	T	T	T	
MTZ2 16H1			I <sub>r</sub> ≤ 1600				T	T	T	T	T	T	T	
MTZ2 20H1			I <sub>r</sub> ≤ 2000					T	T	T	T	T	T	
MTZ2 25H1			I <sub>r</sub> ≤ 2500						T	T	T	T	T	
MTZ2 32H1			I <sub>r</sub> ≤ 3200							T	T	T	T	
MTZ2 40H1			I <sub>r</sub> ≤ 4000								T	T	T	
MTZ3 40H1	100	100	I <sub>r</sub> ≤ 4000							66/145	85/187	85/187	85/187	
MTZ3 50H1			I <sub>r</sub> ≤ 5000									85/187	85/187	
MTZ3 63H1			I <sub>r</sub> ≤ 6300										85/187	
MTZ2 08H2	85	85	I <sub>r</sub> ≤ 800	66/145	66/145	66/145	66/145	66/145	66/145	66/145	66/145	T	T	T
MTZ2 10H2			I <sub>r</sub> ≤ 1000		66/145	66/145	66/145	66/145	66/145	66/145	66/145	T	T	T
MTZ2 12H2			I <sub>r</sub> ≤ 1250			66/145	66/145	66/145	66/145	66/145	66/145	T	T	T
MTZ2 16H2			I <sub>r</sub> ≤ 1600				66/145	66/145	66/145	66/145	66/145	T	T	T
MTZ2 20H2			I <sub>r</sub> ≤ 2000					66/145	66/145	66/145	66/145	T	T	T
MTZ2 25H2			I <sub>r</sub> ≤ 2500						66/145	66/145	66/145	T	T	T
MTZ2 32H2			I <sub>r</sub> ≤ 3200							66/145	66/145	T	T	T
MTZ2 40H2			I <sub>r</sub> ≤ 4000								66/145	T	T	T
MTZ2 08L1	130	100	I <sub>r</sub> ≤ 800	66/145	66/145	66/145	66/145	66/145	66/145	66/145	66/145	85/187	85/187	85/187
MTZ2 10L1			I <sub>r</sub> ≤ 1000		66/145	66/145	66/145	66/145	66/145	66/145	66/145	85/187	85/187	85/187
MTZ2 12L1			I <sub>r</sub> ≤ 1250			66/145	66/145	66/145	66/145	66/145	66/145	85/187	85/187	85/187
MTZ2 16L1			I <sub>r</sub> ≤ 1600				66/145	66/145	66/145	66/145	66/145	85/187	85/187	85/187
MTZ2 20L1			I <sub>r</sub> ≤ 2000					66/145	66/145	66/145	66/145	85/187	85/187	85/187
MTZ2 20H3	130	100	I <sub>r</sub> ≤ 2000					66/145	66/145	66/145	66/145	85/187	85/187	85/187
MTZ2 25H3			I <sub>r</sub> ≤ 2500						66/145	66/145	66/145	85/187	85/187	85/187
MTZ2 32H3			I <sub>r</sub> ≤ 3200							66/145	66/145	85/187	85/187	85/187
MTZ2 40H3			I <sub>r</sub> ≤ 4000								66/145	85/187	85/187	85/187
MTZ3 40H2	130	100	I <sub>r</sub> ≤ 4000								66/145	85/187	85/187	85/187
MTZ3 50H2			I <sub>r</sub> ≤ 5000										85/187	85/187
MTZ3 63H2			I <sub>r</sub> ≤ 6300											85/187

**T** : Protection of the switch-disconnector is ensured but combination not very relevant

**T** : Switch-disconnector is totally coordinated up to Icu of circuit breaker installed on supply side

36/75 : Switch-disconnector is protected up to 36 kA rms / 75 kA

: Protection of the switch-disconnector is not ensured



# Switch-disconnector - Circuit breaker coordination

Upstream: Masterpact MTZ2, MTZ3

Downstream: Masterpact NW HF, NW HH

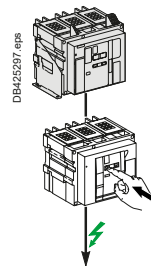

Ue: 500-525 V AC

Ue: 690 V AC

Downstream	Switch-disconnector	NW08	NW10	NW12	NW16	NW20	NW25	NW32	NW40	NW40b	NW50	NW63	
		HF	HF	HF	HF	HF	HF	HF	HF	HH	HH	HH	
		Ith A 60°	800	1000	1250	1600	2000	2500	3200	4000	4000	5000	6300
		Icw (kA)	85	85	85	85	85	85	85	85	100	100	100
Icm (kA)	187	187	187	187	187	187	187	187	187	220	220	220	

Upstream	Icu (kA)		Setting	Switch-disconnector conditional short-circuit current and related making capacity														
	525 V	690 V		Ir														
MTZ2 08N1	42	42	Ir ≤ 800	T	T	T	T	T	T	T	T	T	T	T	T	T		
			Ir ≤ 1000		T	T	T	T	T	T	T	T	T	T	T	T		
			Ir ≤ 1250			T	T	T	T	T	T	T	T	T	T	T	T	
			Ir ≤ 1600				T	T	T	T	T	T	T	T	T	T	T	
			Ir ≤ 2000						T	T	T	T	T	T	T	T	T	
MTZ2 08H1	66	66	Ir ≤ 800	T	T	T	T	T	T	T	T	T	T	T	T	T		
			Ir ≤ 1000		T	T	T	T	T	T	T	T	T	T	T	T		
			Ir ≤ 1250			T	T	T	T	T	T	T	T	T	T	T		
			Ir ≤ 1600				T	T	T	T	T	T	T	T	T	T		
			Ir ≤ 2000						T	T	T	T	T	T	T	T		
			Ir ≤ 2500							T	T	T	T	T	T	T		
			Ir ≤ 3200								T	T	T	T	T	T		
			Ir ≤ 4000									T	T	T	T	T		
			MTZ3 40H1	100	100	Ir ≤ 2500						85/187	85/187	85/187	T	T	T	T
						Ir ≤ 3200							85/187	85/187	T	T	T	T
Ir ≤ 4000											85/187	85/187	T	T	T			
Ir ≤ 5000														T	T			
MTZ2 08H2	85	85	Ir ≤ 800	T	T	T	T	T	T	T	T	T	T	T	T			
			Ir ≤ 1000		T	T	T	T	T	T	T	T	T	T	T			
			Ir ≤ 1250			T	T	T	T	T	T	T	T	T	T			
			Ir ≤ 1600				T	T	T	T	T	T	T	T	T			
			Ir ≤ 2000					T	T	T	T	T	T	T	T			
			Ir ≤ 2500						T	T	T	T	T	T	T			
			Ir ≤ 3200							T	T	T	T	T	T			
			Ir ≤ 4000								T	T	T	T	T			
			MTZ2 08L1	130	100	Ir ≤ 800	85/187	85/187	85/187	85/187	85/187	85/187	85/187	85/187	100/220	100/220	100/220	
Ir ≤ 1000		85/187				85/187	85/187	85/187	85/187	85/187	85/187	100/220	100/220	100/220				
Ir ≤ 1250						85/187	85/187	85/187	85/187	85/187	85/187	100/220	100/220	100/220				
Ir ≤ 1600							85/187	85/187	85/187	85/187	85/187	100/220	100/220	100/220				
Ir ≤ 2000								85/187	85/187	85/187	85/187	100/220	100/220	100/220				
MTZ2 20H3	130	100	Ir ≤ 2000					85/187	85/187	85/187	85/187	100/220	100/220	100/220				
			Ir ≤ 2500						85/187	85/187	85/187	100/220	100/220	100/220				
			Ir ≤ 3200							85/187	85/187	100/220	100/220	100/220				
			Ir ≤ 4000								85/187	85/187	100/220	100/220				
MTZ3 40H2	130	100	Ir ≤ 2500						85/187	85/187	85/187	100/220	100/220	100/220				
			Ir ≤ 3200							85/187	85/187	100/220	100/220	100/220				
			Ir ≤ 4000								85/187	85/187	100/220	100/220				
MTZ3 50H2	130	100	Ir ≤ 2500										100/220	100/220				
			Ir ≤ 3200											100/220	100/220			
			Ir ≤ 4000												100/220	100/220		
MTZ3 63H2	130	100	Ir ≤ 2500											100/220	100/220			
			Ir ≤ 3200												100/220	100/220		
			Ir ≤ 4000													100/220	100/220	

- T : Protection of the switch-disconnector is ensured but combination not very relevant
- T : Switch-disconnector is totally coordinated up to Icu of circuit breaker installed on supply side
- 36/75 : Switch-disconnector is protected up to 36 kA rms / 75 kA
- : Protection of the switch-disconnector is not ensured

# Switch-disconnector - Fuse coordination

Upstream: gG Fuse

Downstream: iSW-NA, iID, iSW, NG125NA

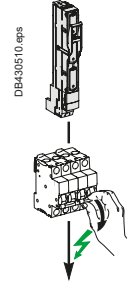

Ue ≤ 440 V AC

Downstream	Switch-disconnector	iSW-NA				iID [1]				
		Rating (A)	40	63	80	100	25	40	63	100
	Icw (kA)	800	1260	1600	2000	500	800	1260	1200	1500
	Icm (kA)	5	5	5	5	5	5	5	5	5

Upstream		Switch-disconnector conditionnal short-circuit current and related making capacity								
Fuse type	Rating (A)									
gG fuse link without overload relay	16	T	T	T	T	T	T	T	T	T
	20	T	T	T	T		T	T	T	T
	25	T	T	T	T		T	T	T	T
	32		80/176	80/176	80/176			80/176	80/176	80/176
	40		80/176	80/176	80/176			80/176	80/176	80/176
	50			30/63	30/63				30/63	30/63
	63				30/63					30/63

Downstream	Switch-disconnector	iSW				NG125NA			
		Rating (A)	40	63	100	125	63	80	100
	Icw (kA)	1.5	1.5	1.5	1.5	1.5	1.5	1.5	1.5
	Icm (kA)	5	5	5	5	2	2	2	2

Upstream		Switch-disconnector conditionnal short-circuit current and related making capacity								
Fuse type	Rating (A)									
gG fuse link without overload relay	16	60/132	60/132	60/132	60/132	T	T	T	T	T
	20	40/84	40/84	40/84	40/84	T	T	T	T	T
	25	25/52	25/52	25/52	25/52	T	T	T	T	T
	32		20/40	20/40	20/40	80/176	80/176	80/176	80/176	80/176
	40		10/17	10/17	10/17	80/176	80/176	80/176	80/176	80/176
	50			10/17	10/17		50/105	50/105	50/105	50/105
	63			10/17	10/17			50/105	50/105	50/105
	80				10/17				50/105	50/105

**T** : Switch-disconnector is totally coordinated up to Icu of circuit breaker installed on supply side

**36/75** : Switch-disconnector is protected up to 36 kA rms / 75 kA

: Protection of the switch-disconnector is not ensured

[1] See Guide CA908023 for additional information.

Note: Current limitation characteristics can be significantly different from one manufacturer to another. This table can not dispense to check selected fuse characteristics

# Switch-disconnector - Fuse coordination

Upstream: gG, aM, BS fuses

Downstream: Compact INS40 to 630, INV100 to 360

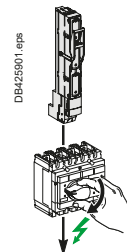

Ue ≤ 500 V AC

Downstream	Switch-Disconnector Ith (A) 60°	Compact INS 40 - 160						Compact INS250 Compact INV				Compact INS Compact INV			
		40	63	80	100	125	160	100	160	200	250	320	400	500	630
	Icw (kA)	3	3	3	5.5	5.5	5.5	8.5	8.5	8.5	8.5	20	20	20	20
	Icm (kA)	15	15	15	20	20	20	30	30	30	30	50	50	50	50

Upstream	Fuse type	Rating	Switch-disconnector conditionnal short-circuit current and related making capacity													
gG fuse link without overload relay	25	T	T	T	T	T	T	T	T	T	T	T	T	T	T	
	32	T	T	T	T	T	T	T	T	T	T	T	T	T	T	
	40		T	T	T	T	T	T	T	T	T	T	T	T	T	
	50		T	T	T	T	T	T	T	T	T	T	T	T	T	
	63				T	T	T	T	T	T	T	T	T	T	T	
	80				T	T	T	T	T	T	T	T	T	T	T	
	100					T	T	T	T	T	T	T	T	T	T	
	125						T	T	T	T	T	T	T	T	T	
	160							T	T	T	T	T	T	T	T	
	200								T	T	T	T	T	T	T	
	225-250									T	T	T	T	T	T	
	300-315										T	T	T	T	T	
	355											T	T	T	T	
	400												T	T	T	
450													T	T		
500														T		
gG fuse link with overload relay	40	T	T	T	T	T	T	T	T	T	T	T	T	T	T	
	50-63	T	T	T	T	T	T	T	T	T	T	T	T	T	T	
	80	T	T	T	T	T	T	T	T	T	T	T	T	T	T	
	100	T	T	T	T	T	T	T	T	T	T	T	T	T	T	
	125	80/176	80/176	80/176	T	T	T	T	T	T	T	T	T	T	T	
	160	36/75	36/75	36/75	50/105	50/105	50/105	T	T	T	T	T	T	T	T	
	200				36/75	36/75	36/75	T	T	T	T	T	T	T	T	
	225-250							T	T	T	T	T	T	T	T	
	300							T	T	T	T	T	T	T	T	
	315							T	T	T	T	T	T	T	T	
	355							50/105	50/105	50/105	50/105	T	T	T	T	
	400-450											T	T	T	T	
	500											T	T	T	T	
	630											50/105	50/105	50/105	50/105	
800														50/105		
aM Fuse link with overload relay	40	T	T	T	T	T	T	T	T	T	T	T	T	T	T	
	50 - 63	T	T	T	T	T	T	T	T	T	T	T	T	T	T	
	80	80/176	80/176	80/176	T	T	T	T	T	T	T	T	T	T	T	
	100	50/105	50/105	50/105	T	T	T	T	T	T	T	T	T	T	T	
	125				T	T	T	T	T	T	T	T	T	T	T	
	160				50/105	50/105	50/105	T	T	T	T	T	T	T	T	
	200				36/75	36/75	36/75	T	T	T	T	T	T	T	T	
	225							80/176	80/176	80/176	80/176	T	T	T	T	
	250							50/105	50/105	50/105	50/105	T	T	T	T	
	300-315											T	T	T	T	
	355-400											T	T	T	T	
	450											50/105	50/105	50/105	50/105	
	500											50/105	50/105	50/105	50/105	
	630											30/63	30/63	30/63	30/63	
BS Fuse link with overload relay	32M63	T	T	T	T	T	T	T	T	T	T	T	T	T	T	
	63M80	T	T	T	T	T	T	T	T	T	T	T	T	T	T	
	63M100	T	T	T	T	T	T	T	T	T	T	T	T	T	T	
	100M125	50/105	50/105	50/105	T	T	T	T	T	T	T	T	T	T	T	
	100M160				50/105	50/105	50/105	T	T	T	T	T	T	T	T	
	100M200							T	T	T	T	T	T	T	T	
	200M250							T	T	T	T	T	T	T	T	
	200M315											T	T	T	T	
	315M400											50/105	50/105	50/105	50/105	
	400M500											40/84	40/84	40/84	40/84	

- T** : Protection of the switch-disconnector is ensured but combination not very relevant
- T** : Switch-disconnector is totally coordinated up to the breaking capacity of the fuse installed on supply side.
- 36/75** : Switch-disconnector is protected up to 36 kA rms / 75 kA
- : Protection of the switch-disconnector is not ensured

**Note:** Current limitation characteristics can be significantly different from one manufacturer to another. This table can not dispense to check selected fuse characteristics

# Switch-disconnector - Fuse coordination

Upstream: gG, aM, BS fuses

Downstream: Compact NSXm50 to 160NA, NSX100 to 630NA

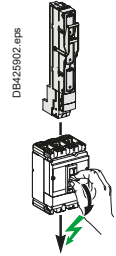

$U_e \leq 500 \text{ V AC}$

Downstream	Switch-Disconnector	NSXm50NA	NSXm100NA	NSXm160NA	NSX100NA	NSX160NA	NSX250NA	NSX400NA	NSX630NA
	Ith (A) 60°	50	100	160	100	160	250	400	630
	Icw (kA)	50	100	160	1.8	2.5	3.5	5	6
	Icm (kA)	0.9	1.5	1.5	2.6	3.6	4.9	7.1	8.5
		1.38	2.13	2.13					

Upstream		Switch-disconnector conditionnal short-circuit current and related making capacity								
Fuse type	Rating									
gG fuse link without overload relay	40	T	T	T	T	T	T	T	T	T
	50-63		T	T	T	T	T	T	T	T
	80		T	T	T	T	T	T	T	T
	100			T	T	T	T	T	T	T
	125			T		T	T	T	T	T
	160					T	T	T	T	T
	200						T	T	T	T
	225-250							T	T	T
	300-315								T	T
	355									T
	400-450									T
500									T	
gG fuse link with overload relay	40	T	T	T	T	T	T	T	T	T
	50-63	T	T	T	T	T	T	T	T	T
	80		T	T	T	T	T	T	T	T
	100		T	T	T	T	T	T	T	T
	125			T		T	T	T	T	T
	160			T		T	T	T	T	T
	200						T	T	T	T
	225-250							T	T	T
	300-315								T	T
	355									T
	400-450									T
500									T	
630									T	
aM Fuse link with overload relay	40	T	T	T	T	T	T	T	T	T
	50 - 63	T	T	T	T	T	T	T	T	T
	80		T	T	T	T	T	T	T	T
	100		T	T	T	T	T	T	T	T
	125			T		T	T	T	T	T
	160			T		T	T	T	T	T
	200						T	T	T	T
	225-250							T	T	T
	300-315								T	T
	355									T
	400-450									T
500									T	
630									T	
BS Fuse link with overload relay	32M63	T	T	T	T	T	T	T	T	T
	63M80		T	T	T	T	T	T	T	T
	63M100		T	T	T	T	T	T	T	T
	100M125		T	T	T	T	T	T	T	T
	100M160		T	T	T	T	T	T	T	T
	100M200						T	T	T	T
	200M250							T	T	T
	200M315								T	T
	315M400									T
	400M500									T

- T** : Protection of the switch-disconnector is ensured but combination not very relevant
- T** : Switch-disconnector is totally coordinated up to Icu of circuit breaker installed on supply side
- : Protection of the switch-disconnector is not ensured

Note: Current limitation characteristics can be significantly different from one manufacturer to another. This table can not dispense to check selected fuse characteristics

# Switch-disconnector - Fuse coordination

Upstream: gG, aM, BS fuses

Downstream: Compact INS40 to 630, INV100 to 630

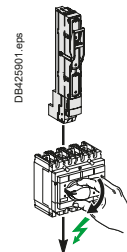

Ue ≤ 690 V AC

Downstream	Switch-Disconnector	Compact INS 40 - 160			Compact INS250 Compact INV				Compact INS Compact INV			
		100	125	160	100	160	200	250	320	400	500	630
	Ith (A) 60°	5.5	5.5	5.5	8.5	8.5	8.5	8.5	20	20	20	20
	Icw (kA)	20	20	20	30	30	30	30	50	50	50	50
	Icm (kA)											

Upstream													
Fuse type	Rating												
gG fuse link without overload relay	25	T	T	T	T	T	T	T	T	T	T	T	T
	32	T	T	T	T	T	T	T	T	T	T	T	T
	40	T	T	T	T	T	T	T	T	T	T	T	T
	50	T	T	T	T	T	T	T	T	T	T	T	T
	63	T	T	T	T	T	T	T	T	T	T	T	T
	80	T	T	T	T	T	T	T	T	T	T	T	T
	100	T	T	T	T	T	T	T	T	T	T	T	T
	125		T		T	T	T	T	T	T	T	T	T
	160					T	T	T	T	T	T	T	T
	200						T	T	T	T	T	T	T
	225-250							T	T	T	T	T	T
	300-315								T	T	T	T	T
	355									T	T	T	T
	400									T	T	T	T
	450										T	T	T
500											T	T	
gG fuse link with overload relay	40	T	T	T	T	T	T	T	T	T	T	T	T
	50-63	T	T	T	T	T	T	T	T	T	T	T	T
	80	T	T	T	T	T	T	T	T	T	T	T	T
	100	T	T	T	T	T	T	T	T	T	T	T	T
	125	T	T	T	T	T	T	T	T	T	T	T	T
	160			T	T	T	T	T	T	T	T	T	T
	200			T	T	T	T	T	T	T	T	T	T
	225-250							T	T	T	T	T	T
	300							T	T	T	T	T	T
	315							T	T	T	T	T	T
	355							T	T	T	T	T	T
	400-450							T	T	T	T	T	T
	500								T	T	T	T	T
630								50/105	50/105	50/105	50/105	50/105	
800													
aM Fuse link with overload relay	40	T	T	T	T	T	T	T	T	T	T	T	T
	50 - 63	T	T	T	T	T	T	T	T	T	T	T	T
	80	T	T	T	T	T	T	T	T	T	T	T	T
	100	T	T	T	T	T	T	T	T	T	T	T	T
	125			T	T	T	T	T	T	T	T	T	T
	160			T	T	T	T	T	T	T	T	T	T
	200			T	T	T	T	T	T	T	T	T	T
	225				50/105	50/105	50/105	50/105					
	250							T	T	T	T	T	T
	300-315							T	T	T	T	T	T
	355-400							T	T	T	T	T	T
	450								50/105	50/105	50/105	50/105	50/105
	500								50/105	50/105	50/105	50/105	50/105
	630												30/63

- T : Protection of the switch-disconnector is ensured but combination not very relevant
- T : Switch-disconnector is totally coordinated up to Icu of circuit breaker installed on supply side
- 36/75 : Switch-disconnector is protected up to 36 kA rms / 75 kA
- : Protection of the switch-disconnector is not ensured

**Note:** Current limitation characteristics can be significantly different from one manufacturer to another. This table can not dispense to check selected fuse characteristics.

# Protection of LV/LV transformers and capacitors

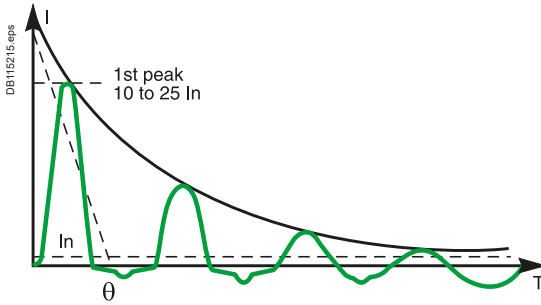

### Inrush currents

When LV/LV transformers are switched on, very high inrush currents are produced which must be taken into account when choosing overcurrent protection devices. The peak value of the first current wave often reaches 10 to 15 times the rated rms current of the transformer and may reach values of 20 to 25 times the rated current even for transformers rated less than 50 kVA.

### Selecting the protection

The values in the tables have been calculated for a crest factor of 25. These tables indicate the circuit breaker and trip unit to be used depending on:

- the primary supply voltage (230 V or 400 V)
- the type of transformer (single-phase or three-phase).

They correspond to the most frequent case of step down-transformer in which the primary is wound externally<sup>[1]</sup> with no de-rating for harmonics (K-factor = 1). The type of circuit breaker to be used (i.e. N, H or L) depends on the breaking capacity required at the point of installation.

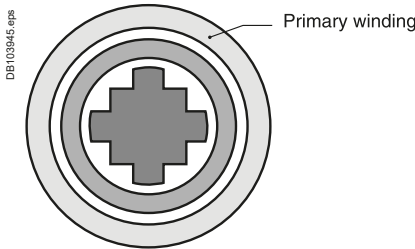

Transformer Power rating (kVA)			Circuit breaker		
230-240V 1-ph	230-240V 3-ph 400-415V 1-ph	400-415V 3-ph	Type	Curve	Rating
0.05	0.09	0.16	iC60	D or K	0.5
0.11	0.18	0.32	iC60	D or K	1
0.21	0.36	0.63	iC60	D or K	2
0.33	0.58	1.0	iC60	D or K	3
0.67	1.2	2.0	iC60	D or K	6
1.1	1.8	3.2	iC60,NG125	D or K	10
1.7	2.9	5.0	iC60,NG125	D or K	16
2.1	3.6	6.3	iC60,NG125	D or K	20
2.7	4.6	8.0	iC60,NG125	D or K	25
3.3	5.8	10	iC60,NG125	D or K	32
4.2	7.2	13	iC60,NG125	D or K	40
5.3	9.2	16	iC60,NG125	D or K	50
6.7	12	20	iC60,NG125	D or K	63
8.3	14	25	C120,NG125	D or K	80
11	18	32	C120,NG125	D or K	100
13	23	40	C120,NG125	D or K	125

### Protection using a Compact circuit breaker (1st peak ≤ 25 In)

Compact NSX100 to NSX250 equipped with TM-D thermal-magnetic trip unit			Protective device		
Transformer rating (kVA)			Circuit breakers		
230/240 V 1-phase	230/240 V 3-phases 400/415 V 1-phase	400/415 V 3-phases		Trip unit	I <sub>r</sub> max setting
3	5 to 6	9 to 12	NSX100B/F/N/H/S/L	TM16D	1
5	8 to 9	14 to 16	NSX100B/F/N/H/S/L	TM25D	1
7 to 9	13 to 16	22 to 28	NSX100B/F/N/H/S/L/R	TM40D	1
12 to 15	20 to 25	35 to 44	NSX100B/F/N/H/S/L/R	TM63D	1
16 to 19	26 to 32	45 to 56	NSX100B/F/N/H/S/L/R	TM80D	1
18 to 23	32 to 40	55 to 69	NSX160B/F/N/H/S/L	TM100D	1
23 to 29	40 to 50	69 to 87	NSX160B/F/N/H/S/L	TM125D	1
29 to 37	51 to 64	89 to 111	NSX250B/F/N/H/S/L/R	TM160D	1
37 to 46	64 to 80	111 to 139	NSX250B/F/N/H/S/L/R	TM200D	1

### Compact NSX100 to NS1600 / Masterpact equipped with Micrologic trip unit

Transformer rating (kVA)			Protective device		
230/240 V 1-phase	230/240 V 3-phases 400/415 V 1-phase	400/415 V 3-phases	Circuit breakers		
				Trip unit	I <sub>r</sub> max setting
4 to 7	6 to 13	11 to 22	NSX100B/F/N/H/S/L/R	Micrologic 2.2, 4.2, 5.2, 6.2, 7.2 40	0.8
9 to 19	16 to 30	27 to 56	NSX100B/F/N/H/S/L/R	Micrologic 2.2, 4.2, 5.2, 6.2, 7.2 100	0.8
15 to 30	05 to 50	44 to 90	NSX160B/F/N/H/S/L	Micrologic 2.2, 4.2, 5.2, 6.2, 7.2 160	0.8
23 to 46	40 to 80	70 to 139	NSX250B/F/N/H/S/L/R	Micrologic 2.2, 4.2, 5.2, 6.2, 7.2 250	0.8
37 to 65	64 to 112	111 to 195	NSX400F/N/H/S/L/R	Micrologic 2.3, 4.3, 5.3, 6.3, 7.3 400	0.7
58 to 83	100 to 144	175 to 250	NSX630F/N/H/S/L/R	Micrologic 2.3, 4.3, 5.3, 6.3, 7.3 630	0.6
58 to 150	100 to 250	175 to 436	NS630bN/bH-NT06H1	Micrologic 5.0/6.0/7.0	1
74 to 184	107 to 319	222 to 554	NS800N/H-MTZ108H1-MTZ208N1/H1	Micrologic 5.0/6.0/7.0	1
90 to 230	159 to 398	277 to 693	NS1000N/H-MTZ110H1-MTZ210N1/H1	Micrologic 5.0/6.0/7.0	1
115 to 288	200 to 498	346 to 866	NS1250N/H-MTZ112H1-MTZ212N1/H1	Micrologic 5.0/6.0/7.0	1
147 to 368	256 to 640	443 to 1108	NS1600N/H-MTZ116H1-MTZ216N1/H1	Micrologic 5.0/6.0/7.0	1
184 to 460	320 to 800	554 to 1385	MTZ220N1/H1	Micrologic 5.0/6.0/7.0	1
230 to 575	400 to 1000	690 to 1730	MTZ225H2/H3	Micrologic 5.0/6.0/7.0	1
294 to 736	510 to 1280	886 to 2217	MTZ232H2/H3	Micrologic 5.0/6.0/7.0	1

[1] For other windings or special applications, please consult us.

If a circuit breaker upstream of a transformer with a transformation ratio of 1 and a rated power of less than 5 kVA is subject to nuisance tripping, before choosing a circuit breaker with a higher rating, invert the input and the output of the transformer (the inrush current may be doubled if the primary is wound internally rather than externally).

NS630b L, LB, NS800 L LB, NS1000L, MTZ1 06 08 10 L1 can not be used without checking the inrush current is below their fast tripping characteristics. Consult us.

# Protection of LV/LV transformers and capacitors

DB1152/16.eps

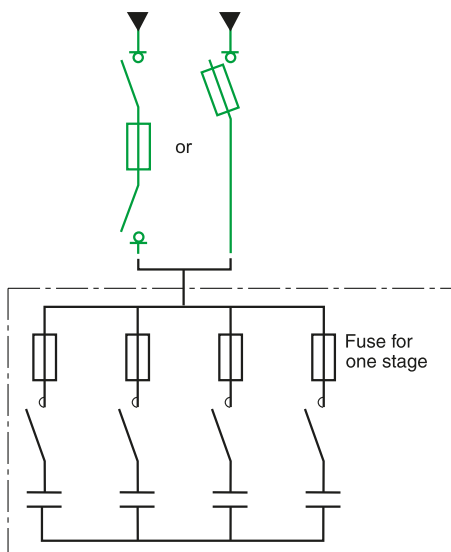

Capacitor-bank protection.

056039A-30.eps



Rectimat 2 capacitor bank.

## Protection of capacitors

It is necessary to take into account:

- permissible variations in the fundamental voltage and in harmonic content
- variations due to capacitor tolerances.

The increase in the current rating for the protection device may reach 30 % (but only 5 % for Rectiphase capacitors).

Given the above, the generally required correction factor ranges from 1.6 to 2.

For Rectiphase capacitor banks, an optimised factor of only 1.4 may be used for standard banks.

### Protection table for fixed or automatic capacitor banks

400/415 V		
Capacitor (kVAR)	gG fuse-link rating	Fupact
10 kVAR	20 A	INF●32 / INFD40
20 kVAR	40 A	INF●63 / INFD40
30 kVAR	63 A	INF●63
50 kVAR	100 A	INF●125
60 kVAR	125 A	INF●125
80 kVAR	160 A	INF●250
105 kVAR	250 A	INF●250
150 kVAR	315 A	INF●400
210 kVAR	450 A	INF●630
315 kVAR	670 A	INF●800

690 V		
Capacitor (kVAR)	gG fuse-link rating	Fupact
10 kVAR	16 A	INF●32 / INFD40
20 kVAR	32 A	INF●32 / INFD40
30 kVAR	40 A	INF●63 / INFD40
50 kVAR	63 A	INF●63
60 kVAR	80 A	INF●125
80 kVAR	100 A	INF●125
105 kVAR	125 A	INF●160
150 kVAR	200 A	INF●250
210 kVAR	250 A	INF●400
315 kVAR	400 A	INF●400
405 kVAR	500 A	INF●630
450 kVAR	560 A	INF●630
495 kVAR	630 A	INF●800
540 kVAR	670 A	INF●800



# Coordination tables between circuit breaker and Canalis electrical busbar trunking

When choosing a circuit breaker to protect a busbar trunking system, it is necessary to take into account:

- the usual rules concerning the circuit breaker current settings:

$I_b \leq I_r \leq I_{nc}$  where:

$I_b$  = maximum load current

$I_r$  = circuit breaker current setting

$I_{nc}$  = current rating of the busbar trunking

- the electrodynamic withstand of the busbar trunking: the peak current  $\hat{I}$  limited by the circuit breaker must be less than the electrodynamic withstand capacity (or rated peak current) of the busbar trunking.

The following tables provide maximum prospective short-circuit current where busbar trunking systems can be installed in coordination with specified circuit breaker.

Different coordination tables are provided for 400V AC and 690V AC systems

### How to read the table

Example Canalis KSA630 Ue: 400V AC.

Type of Canalis busbar trunking KSA630		≤ 32 kA	36 kA	50 kA	70 kA	100 kA	150 kA
Type of circuit breaker	Compact NSX	NSX400F/N/H/S/L <b>NSX630F/N/H/S/L</b>		NSX400N/H/S/L <b>NSX630N/H/S/L</b>	NSX400H/S/L <b>NSX630H/S/L</b>	NSX400S/L <b>NSX630S/L</b>	NSX400L <b>NSX630L</b>
	Compact NS	NS630b N/H/L/LB NS800N/H/L/LB		NS630b L/LB NS800L/LB			NS630b LB NS800LB
	Masterpact MTZ1	MTZ1 06 H1/H2/H3/L1 MTZ1 08 H1/H2/H3/L1		MTZ1 06 L1 MTZ1 08 L1			
Family of circuit breaker		For a presumed short-circuit current of 65kA NSX400H/S/L, NSX630H/S/L, NS630b L/LB, NS800 L/LB, MTZ1 06L1 08L1 can be used to protect the canalis. The bold line is the optimized solution.					

E



# Coordination tables between circuit breaker and Canalis electrical busbar trunking

### Example

Consider two 630 kVA/400 V transformer (Usc 4 %) supplying a main LV switchboard for which the prospective short-circuit current on the busbars is 44 kA.

From the switchboard, a 30-metre long Canalis KSA630 transmission electrical busbar trunking system (630 A) supplies a Canalis KSA630 trunking system (630A) for distribution with high-density tap-offs.

A tap-off on the KSA630 trunking supplies a Canalis KSA160 trunking system.

The short-circuit level are respectively:

- 44 kA downstream of circuit breaker CB1 and at the upstream connection of the KSA630 trunking
- 33 kA at the junction between the KSA630 transmission trunking and the KSA630 trunking for high-density tap-offs.

**What circuit breakers should be chosen for CB1 and CB2 to protect the installation against short-circuits?**

	CB1	CB2
Prospective Isc	44 kA	33 kA
Circuit breakers	NSX630N (50 kA breaking capacity)	NSX160F (36 kA breaking capacity)
Isc protection level for KSA630 trunking	50 kA	
Isc protection level for KSA160 trunking		35 kA

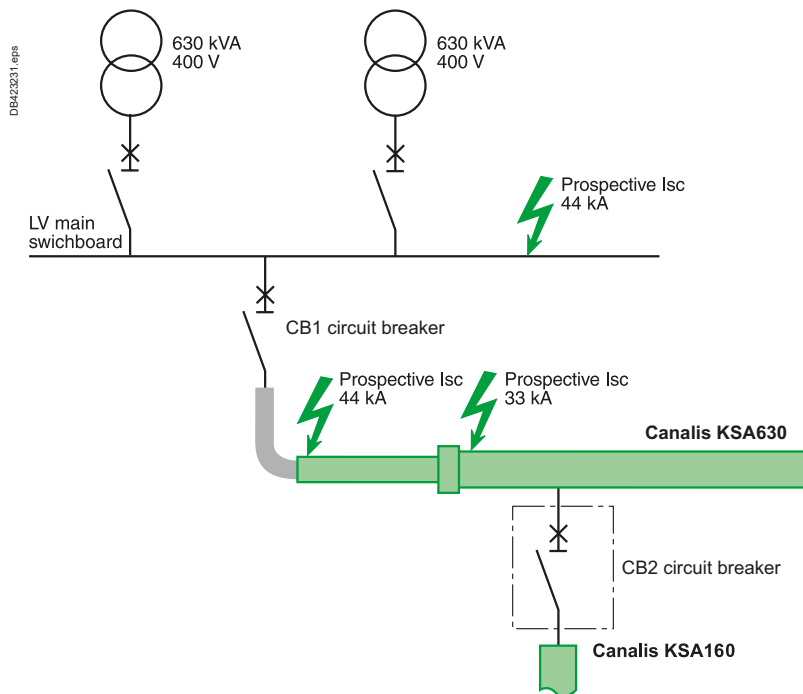

# Coordination tables between circuit breaker and Canalis electrical busbar trunking

## Canalis KDP KBA KBB L+N+PE

U<sub>e</sub>: 220 or 240 V AC Ph/N

Type of Canalis busbar trunking KDP20 L + N + PE						
Isc max. in kA rms		10 kA	15 kA	20 kA		
Type of circuit breaker	iC60	iC60N 10/16/20	iC60H 10/16/20	iC60L 10/16/20		
Isc max. in kA rms	NG	NG125N 10/16/20				
Type of Canalis busbar trunking KBA25 L + N + PE						
Isc max. in kA rms		10 kA	15 kA	20 kA	25 kA	
Type of circuit breaker	iC60	iC60N 10/.../25	iC60H 10/.../25	iC60L 10/.../25	iC60L 10/.../25	
Isc max. in kA rms	NG	NG125N 10/.../25				
Type of Canalis busbar trunking KBB25 L + N + PE						
Isc max. in kA rms		10 kA	15 kA	20 kA	25 kA	
Type of circuit breaker	iC60	iC60N 10/.../25	iC60H 10/.../25	iC60L 10/.../25	iC60L 10/.../25	
Isc max. in kA rms	NG	NG125N 10/.../25				
Type of Canalis busbar trunking KBA40 L + N + PE						
Isc max. in kA rms		10 kA	15 kA	20 kA	25 kA	50 kA
Type of circuit breaker	iC60	iC60N 10/.../40	iC60H 10/.../40	iC60L 40	iC60L 10/.../25	
Isc max. in kA rms	NG	NG125N 10/.../40	NG125N 10/.../40	NG125N 10/.../40	NG125N 10/.../40	NG125L 10/.../40
Type of Canalis busbar trunking KBB40 L + N + PE						
Isc max. in kA rms		10 kA	15 kA	20 kA	25 kA	50 kA
Type of circuit breaker	iC60	iC60N 10/.../40	iC60H 10/.../40	iC60L 40	iC60L 10/.../25	
Isc max. in kA rms	NG	NG125N 10/.../40	NG125N 10/.../40	NG125N 10/.../40	NG125N 10/.../40	NG125L 10/.../40

# Coordination tables between circuit breaker and Canalis electrical busbar trunking

Canalis KDP KBA KBB 3L+N+PE, KNA  
Ue: 380-415 V AC

Type of Canalis busbar trunking KDP20 3L+N+PE												
Isc max. in kA rms	10 kA		15 kA		20 kA							
Type of circuit breaker	iC60	iC60N 10/16/20	iC60H 10/16/20	iC60L 10/16/20								
	NG125	NG125N 10/16/20										
Type of Canalis busbar trunking KBA25 3L+N+PE												
Isc max. in kA rms	10 kA		15 kA		20 kA		25 kA					
Type of circuit breaker	iC60	iC60N 10/.../25	iC60H 10/.../25	iC60L 10/.../25	iC60L 10/.../25							
	NG125	NG125N 10/.../25										
Type of Canalis busbar trunking KBB25 3L+N+PE												
Isc max. in kA rms	10 kA		15 kA		20 kA		25 kA					
Type of circuit breaker	iC60	iC60N 10/.../25	iC60H 10/.../25	iC60L 10/.../25	iC60L 10/.../25							
	NG125	NG125N 10/.../25										
Type of Canalis busbar trunking KBA40 3L+N+PE												
Isc max. in kA rms	10 kA		15 kA		20 kA		25 kA		36 kA		50 kA	
Type of circuit breaker	iC60	iC60N 10/.../40	iC60H 10/.../40	iC60L 40	iC60L 10/.../25							
	NG125	NG125N 10/.../40	NG125N 10/.../40	NG125N 10/.../40	NG125N 10/.../40	NG125N 10/.../40	NG125H 10/.../40	NG125L 10/.../40				
Type of Canalis busbar trunking KBB40 3L+N+PE												
Isc max. in kA rms	10 kA		15 kA		20 kA		25 kA		36 kA		50 kA	
Type of circuit breaker	iC60	iC60N 10/.../40	iC60H 10/.../40	iC60L 40	iC60L 10/.../25							
	NG125	NG125N 10/.../40	NG125N 10/.../40	NG125N 10/.../40	NG125N 10/.../40	NG125N 10/.../40	NG125H 10/.../40	NG125L 10/.../40				
Type of Canalis busbar trunking KNA40												
Isc max. in kA rms	10 kA		15 kA		20 kA		25 kA					
Type of circuit breaker	iC60	iC60N 40	iC60H 40		iC60L 40							
	NG125	NG125N/H/L 40										
	Compact NSXm	NSXm E/B/F/N/H 40A			NSXm B/F/N/H 40A							
	Compact NSX	NSX100B/F/N/H/S/L 40A										
Type of Canalis busbar trunking KNA63												
Isc max. in kA rms	10 kA		15 kA		20 kA		25 kA		36 kA		50 kA	
Type of circuit breaker	iC60	iC60N 63	iC60H 63									
	C120	C120N 63	C120H 63									
	NG125	NG125N/H/L 63					NG125H 63	NG125L 63				
	Compact NSXm	NSXm E/B/F/N/H 63A			NSXm B/F/N/H 63A							
	Compact NSX	NSX100B/F/N/H/S/L 63A										
Type of Canalis busbar trunking KNA100												
Isc max. in kA rms	10 kA		15 kA		20 kA		25 kA		36 kA		50 kA	
Type of circuit breaker	C120	C120N 100A	C120H 100A									
	NG125	NG125N/H/L 100					NG125H/L 80	NG125L 80				
	Compact NSXm	NSXm E/B/F/N/H 100A			NSXm B/F/N/H 100A							
	Compact NSX	NSX100B/F/N/H/S/L										
		NSX160B/F/N/H/S/L										
Type of Canalis busbar trunking KNA160												
Isc max. in kA rms	10 kA		15 kA		20 kA		25 kA		36 kA		50 kA	
Type of circuit breaker	NG125	NG125N125										
	Compact NSXm	NSXm E/B/F/N/H 160			NSXm B/F/N/H 160A			NSXm F/N/H 160A	NSXm N/H 160A			
	Compact NSX	NSX100B/F/N/H/S/L					NSX100F/N/H/S/L	NSX100N/H/S/L				
		NSX160B/F/N/H/S/L					NSX160F/N/H/S/L	NSX160N/H/S/L				
		NSX250B/F/N/H/S/L					NSX250F/N/H/S/L	NSX250N/H/S/L				



# Coordination tables between circuit breaker and Canalis electrical busbar trunking

Canalis KSA  
Ue: 380-415 V AC

Type of Canalis busbar trunking KSA100							
Isc max. in kA rms		25 kA	36 kA	50 kA			
Type of circuit breaker	NG125	NG125N100	NG125H80	NG125L 80			
	Compact NSXm	NSXm B/F/N/H 100	NSXm F/N/H 100				
	Compact NSX	NSX100B/F/N/H/S/L					

Type of Canalis busbar trunking KSA160							
Isc max. in kA rms		25 kA	36 kA	50 kA	70 kA	90 kA	
Type of circuit breaker	Compact NSXm	NSXm B/F/N/H 160	NSXm F/N/H 160	NSXm N/H 160	NSXm H 160		
	Compact NSX	NSX100B/F/N/H/S/L	NSX100F/N/H/S/L	NSX100N/H/S/L	NSX100H/S/L	NSX100S/L	
		NSX160B/F/N/H/S/L	NSX160F/N/H/S/L	NSX160N/H/S/L	NSX160H/S/L		
		NSX250B/F/N/H/S/L	NSX250F/N/H/S/L	NSX250N/H/S/L			

Type of Canalis busbar trunking KSA250							
Isc max. in kA rms		25 kA	36 kA	50 kA	70 kA	100 kA	150 kA
Type of circuit breaker	Compact NSX	NSX160B/F/N/H/S/L	NSX160F/N/H/S/L	NSX160N/H/S/L	NSX160H/S/L	NSX160S/L	NSX160L
		NSX250B/F/N/H/S/L	NSX250F/N/H/S/L	NSX250N/H/S/L	NSX250H/S/L	NSX250S/L	NSX250L
		NSX400F/N/H/S/L	NSX400F/N/H/S/L	NSX400N/H/S/L			

Type of Canalis busbar trunking KSA400							
Isc max. in kA rms		25 kA	36 kA	50 kA	70 kA	100 kA	150 kA
Type of circuit breaker	Compact NSX	NSX250B/F/N/H/S/L	NSX250F/N/H/S/L	NSX250N/H/S/L	NSX250H/S/L	NSX250S/L	NSX250L
		NSX400F/N/H/S/L	NSX400F/N/H/S/L	NSX400N/H/S/L	NSX400H/S/L	NSX400S/L	NSX400L
		NSX630F/N/H/S/L	NSX630F/N/H/S/L	NSX630N/H/S/L	NSX630H/S/L	NSX630S/L	NSX630L
	Compact NS	NS630b N/H/L/LB	NS630b L/LB	NS630b L/LB	NS630b LB		

Type of Canalis busbar trunking KSA500							
Isc max. in kA rms		25 kA	36 kA	50 kA	70 kA	100 kA	150 kA
Type of circuit breaker	Compact NSX	NSX400F/N/H/S/L	NSX400F/N/H/S/L	NSX400N/H/S/L	NSX400H/S/L	NSX400S/L	NSX400L
		NSX630F/N/H/S/L	NSX630F/N/H/S/L	NSX630N/H/S/L	NSX630H/S/L	NSX630S/L	NSX630L
	Compact NS	NS630b N/H/L/LB		NS630b L / LB	NS630b LB		

Type of Canalis busbar trunking KSA630							
Isc max. in kA rms		≤ 32 kA	36 kA	50 kA	70 kA	100 kA	150 kA
Type of circuit breaker	Compact NSX	NSX400F/N/H/S/L		NSX400N/H/S/L	NSX400H/S/L	NSX400S/L	NSX400L
		NSX630F/N/H/S/L		NSX630N/H/S/L	NSX630H/S/L	NSX630S/L	NSX630L
	Compact NS	NS630b N/H/L/LB		NS630b L/LB			NS630b LB
		NS800N/H/L/LB		NS800L/LB			NS800LB
	Masterpact MTZ1	MTZ1 06 H1/H2/H3/L1		MTZ1 06 L1			
		MTZ1 08 H1/H2/H3/L1		MTZ1 08 L1			

Type of Canalis busbar trunking KSA800							
Isc max. in kA rms		25 kA	36 kA	50 kA	70 kA	100 kA	150 kA
Type of circuit breaker	Compact NSX	NSX630F/N/H/S/L		NSX630N/H/S/L	NSX630H/S/L	NSX630S/L	NSX630L
	Compact NS	NS630b N/H/L/LB			NS630b L/LB		
		NS800N/H/L/LB			NS800L/LB		
		NS1000N/H/L			NS1000L		
	Masterpact MTZ1	MTZ1 06 H1/H2/H3/L1		MTZ1 06 L1			
		MTZ1 08 H1/H2/H3/L1		MTZ1 08 L1			
		MTZ1 10 H1/H2/H3/L1		MTZ1 10 L1			

Type of Canalis busbar trunking KSA1000							
Isc max. in kA rms		25 kA	36 kA	50 kA	70 kA	100 kA	150 kA
Type of circuit breaker	Compact NS	NS800N/H/L/LB			NS800L/LB		
		NS1000N/H/L			NS1000L		
		NS1250N/H					
	Masterpact MTZ1	MTZ1 08 H1/H2/H3/L1			MTZ1 08 L1		
		MTZ1 10 H1/H2/H3/L1			MTZ1 10 L1		
		MTZ1 12 H1/H2/H3					



# Coordination tables between circuit breaker and Canalis electrical busbar trunking

Canalis KTA / KTC  
Ue: 380-415 V AC

Type of Canalis busbar trunking KTA0800							
Isc max. in kA rms	≤ 30 kA		50 kA	65 kA	85 kA	100 kA	150 kA
Type of circuit breaker	Compact NSX	NSX630F/NH/S/L	NSX630N/H/S/L	NSX630H/S/L	NSX630S/L	NSX630S/L	NSX630L
	Compact NS	NS630b N/H/L/LB NS800N/H/L/LB NS1000N/H/L/LB		NS630b L/LB NS800L/LB NS1000L			NS630b LB NS800LB
	Masterpact MTZ1	MTZ1 06 H1/H2/H3/L1 MTZ1 08 H1/H2/H3/L1 MTZ1 10 H1/H2/H3/L1		MTZ1 06 L1 MTZ1 08 L1 MTZ1 10 L1			
	Masterpact MTZ2	MTZ2 08 N1/H1/H2/L1 MTZ2 10 N1/H1/H2/L1					

Type of Canalis busbar trunking KTA0800 reinforced short-circuit level							
Isc max. in kA rms	≤ 30 kA		50 kA	65 kA	85 kA	100 kA	150 kA
Type of circuit breaker	Compact NSX	NSX630F/NH/S/L	NSX630N/H/S/L	NSX630H/S/L	NSX630S/L	NSX630S/L	NSX630L
	Compact NS	NS630b N/H/L/LB NS800N/H/L/LB NS1000N/H/L/LB		NS630b L/LB NS800L/LB NS1000L			NS630b LB NS800LB
	Masterpact MTZ1	MTZ1 06 H1/H2/H3/L1 MTZ1 08 H1/H2/H3/L1 MTZ1 10 H1/H2/H3/L1		MTZ1 06 L1 MTZ1 08 L1 MTZ1 10 L1			
	Masterpact MTZ2	MTZ2 08 N1/H1/H2/L1 MTZ2 10 N1/H1/H2/L1					

Type of Canalis busbar trunking KTA1000 / KTC1000							
Isc max. in kA rms	42 kA		50 kA	65 kA	85 kA	100 kA	150 kA
Type of circuit breaker	Compact NS	NS800N/H/L/LB NS1000N/H/L NS1250N/H			NS800L/LB NS1000L		
	Masterpact MTZ1	MTZ1 08 H1/H2/H3/L1 MTZ1 10 H1/H2/H3/L1 MTZ1 12 H1/H2/H3	MTZ1 08 H2/H3/L1 MTZ1 10 H2/H3/L1 MTZ1 12 H2/H3		MTZ1 08 L1 MTZ1 10 L1		
	Masterpact MTZ2	MTZ2 08 N1/H1/H2/L1 MTZ2 10 N1/H1/H2/L1 MTZ2 12 N1/H1/H2/L1	MTZ2 08 H1/H2/L1 MTZ2 10 H1/H2/L1 MTZ2 12 H1/H2/L1				

Type of Canalis busbar trunking KTA1000 / KTC1000 reinforced short-circuit level							
Isc max. in kA rms	42 kA		50 kA	65 kA	85 kA	100 kA	150 kA
Type of circuit breaker	Compact NS	NS800N/H/L/LB NS1000N/H/L NS1250N/H		NS800H/L/LB NS1000H/L NS1250H		NS800L NS1000L	
	Masterpact MTZ1	MTZ1 08 H1/H2/H3/L1 MTZ1 10 H1/H2/H3/L1 MTZ1 12 H1/H2/H3	MTZ1 08 H2/H3/L1 MTZ1 10 H2/H3/L1 MTZ1 12 H2/H3	MTZ1 08 H3/L1 MTZ1 10 H3/L1 MTZ1 12 H3		MTZ1 08 L1 MTZ1 10 L1	
	Masterpact MTZ2	MTZ2 08 N1/H1/H2/L1 MTZ2 10 N1/H1/H2/L1 MTZ2 12 N1/H1/H2/L1	MTZ2 08 H1/H2/L1 MTZ2 10 H1/H2/L1 MTZ2 12 H1/H2/L1		MTZ2 08 L1 MTZ2 10 L1 MTZ2 12 L1		

Type of Canalis busbar trunking KTA1250 / KTC1350							
Isc max. in kA rms	42 kA		50 kA	65 kA	85 kA	100 kA	150 kA
Type of circuit breaker	Compact NS	NS1000N/H NS1250N/H NS1600N/H			NS1000L		
	Masterpact MTZ1	MTZ1 10 H1/H2/H3/L1 MTZ1 12 H1/H2/H3 MTZ1 16 H1/H2/H3	MTZ1 10 H2/H3/L1 MTZ1 12 H2/H3 MTZ1 16 H2/H3		MTZ1 10 L1		
	Masterpact MTZ2	MTZ2 10 N1/H1/H2/L1 MTZ2 12 N1/H1/H2/L1 MTZ2 16 N1/H1/H2/L1	MTZ2 10 H1/H2/L1 MTZ2 12 H1/H2/L1 MTZ2 16 H1/H2/L1				

Type of Canalis busbar trunking KTA1250 / KTC1350 reinforced short-circuit level							
Isc max. in kA rms	42 kA		50 kA	65 kA	85 kA	100 kA	150 kA
Type of circuit breaker	Compact NS	NS1000N/H/L NS1250N/H NS1600N/H		NS1000H/L NS1250H NS1600H		NS1000L	
	Masterpact MTZ1	MTZ1 10 H1/H2/H3/L1 MTZ1 12 H1/H2/H3 MTZ1 16 H1/H2/H3	MTZ1 10 H2/H3/L1 MTZ1 12 H2/H3 MTZ1 16 H2/H3	MTZ1 10 H3/L1 MTZ1 12 H3 MTZ1 16 H3		MTZ1 10 L1	
	Masterpact MTZ2	MTZ2 10 N1/H1/H2/L1 MTZ2 12 N1/H1/H2/L1 MTZ2 16 N1/H1/H2/L1	MTZ2 10 H1/H2/L1 MTZ2 12 H1/H2/L1 MTZ2 16 H1/H2/L1		MTZ2 10 L1 MTZ2 12 L1 MTZ2 16 L1		

Type of Canalis busbar trunking KTA1600 / KTC1600							
Isc max. in kA rms	42 kA		50 kA	65 kA	85 kA	100 kA	150 kA
Type of circuit breaker	Compact NS	NS1250N/H NS1600N/H		NS1250H NS1600H			
		NS1600b N/H NS2000N/H					
	Masterpact MTZ1	MTZ1 12 H1/H2/H3 MTZ1 16 H1/H2/H3	MTZ1 12 H2/H3 MTZ1 16 H2/H3	MTZ1 12 H3 MTZ1 16 H3			
	Masterpact MTZ2	MTZ2 12 N1/H1/H2/L1 MTZ2 16 N1/H1/H2/L1 MTZ2 20 N1/H1/H2/H3/L1	MTZ2 12 H1/H2/L1 MTZ2 16 H1/H2/L1 MTZ2 20 H1/H2/H3/L1		MTZ2 12 L1 MTZ2 16 L1 MTZ2 20 L1		

# Coordination tables between circuit breaker and Canalis electrical busbar trunking

Canalis KTA / KTC  
Ue: 380-415 V AC

Type of Canalis busbar trunking KTA1600 / KTC1600 reinforced short-circuit level							
Isc max. in kA rms		42 kA	50 kA	65 kA	85 kA	100 kA	150 kA
Type of circuit breaker	Compact NS	NS1250N/H NS1600N/H		NS1250H NS1600H			
		NS1600b N/H NS2000N/H			NS1600b H NS2000H		
	Masterpact MTZ1	MTZ1 12 H1/H2/H3 MTZ1 16 H1/H2/H3	MTZ1 12 H2/H3 MTZ1 16 H2/H3	MTZ1 12 H3 MTZ1 16 H3			
	Masterpact MTZ2	MTZ2 12 N1/H1/H2/L1 MTZ2 16 N1/H1/H2/L1 MTZ2 20 N1/H1/H2/H3/L1	MTZ2 12 H1/H2/L1 MTZ2 16 H1/H2/L1 MTZ2 20 H1/H2/H3/L1		MTZ2 12 H2/L1 MTZ2 16 H2/L1 MTZ2 20 H2/H3/L1	MTZ2 12 L1 MTZ2 16 L1 MTZ2 20 L1	
Type of Canalis busbar trunking KTA2000 / KTC2000							
Isc max. in kA rms		42 kA	50 kA	65 kA	85 kA	100 kA	150 kA
Type of circuit breaker	Compact NS	NS1600b N/H NS2000N/H NS2500N/H					
	Masterpact MTZ1	MTZ1 16 H1/H2/H3	MTZ1 16 H2/H3	MTZ1 16 H3			
	Masterpact MTZ2	MTZ2 16 N1/H1/H2/L1 MTZ2 20 N1/H1/H2/H3/L1	MTZ2 16 H1/H2/L1 MTZ2 20 H1/H2/H3/L1		MTZ2 16 L1 MTZ2 20 L1		
		MTZ2 25 H1/H2/H3					
Type of Canalis busbar trunking KTA2000 / KTC2000 reinforced short-circuit level							
Isc max. in kA rms		42 kA	50 kA	65 kA	85 kA	100 kA	150 kA
Type of circuit breaker	Compact NS	NS1600b N/H NS2000N/H			NS1600b H NS2000H		
	Masterpact MTZ1	MTZ1 16 H1/H2/H3	MTZ1 16 H2/H3	MTZ1 16 H3			
	Masterpact MTZ2	MTZ2 16 N1/H1/H2/L1 MTZ2 20 N1/H1/H2/H3/L1	MTZ2 16 H1/H2/L1 MTZ2 20 H1/H2/H3/L1		MTZ2 16 L1 MTZ2 20 L1		
		MTZ2 25 H1/H2/H3					
Type of Canalis busbar trunking KTA2500 / KTC2500							
Isc max. in kA rms		42 kA	50 kA	65 kA	80 kA	100 kA	150 kA
Type of circuit breaker	Masterpact MTZ2	MTZ2 20 H1/H2/H3/L1 MTZ2 25 H1/H2/H3 MTZ2 32 H1/H2/H3			MTZ2 20 H2/H3/L1 MTZ2 25 H2/H3 MTZ2 32 H2/H3	MTZ2 20 L1	MTZ2 20 L1
Type of Canalis busbar trunking KTA2500 / KTC2500 reinforced short-circuit level							
Isc max. in kA rms		42 kA	50 kA	65 kA	80 kA	100 kA	110 kA
Type of circuit breaker	Masterpact MTZ2	MTZ2 20 H1/H2/H3/L1 MTZ2 25 H1/H2/H3 MTZ2 32 H1/H2/H3			MTZ2 20 H2/H3/L1 MTZ2 25 H2/H3 MTZ2 32 H2/H3		MTZ2 20 H3/L1 <sup>[1]</sup> MTZ2 25 H3 MTZ2 32 H3
Type of Canalis busbar trunking KTA3200 / KTC3200							
Isc max. in kA rms		42 kA	50 kA	65 kA	85 kA	100 kA	110 kA
Type of circuit breaker	Masterpact MTZ2	MTZ2 25 H1/H2/H3 MTZ2 32 H1/H2/H3 MTZ2 40 H1/H2/H3			MTZ2 25 H2/H3 MTZ2 32 H2/H3 MTZ2 40 H2/H3		
	Masterpact MTZ3	MTZ3 40 H1/H2					
Type of Canalis busbar trunking KTA3200 / KTC3200 reinforced short-circuit level							
Isc max. in kA rms		42 kA	50 kA	65 kA	85 kA	100 kA	110 kA
Type of circuit breaker	Masterpact MTZ2	MTZ2 25 H1/H2/H3 MTZ2 32 H1/H2/H3 MTZ2 40 H1/H2/H3			MTZ2 25 H2/H3 MTZ2 32 H2/H3 MTZ2 40 H2/H3		MTZ2 25 H3 MTZ2 32 H3 MTZ2 40 H3
	Masterpact MTZ3	MTZ3 40 H1/H2			MTZ3 40 H2		
Type of Canalis busbar trunking KTA4000 / KTC4000							
Isc max. in kA rms		42 kA	50 kA	65 kA	90 kA	100 kA	110 kA
Type of circuit breaker	Masterpact MTZ2	MTZ2 32 H1/H2/H3 MTZ2 40 H1/H2/H3			MTZ2 32 H2/H3 MTZ2 40 H2/H3		
	Masterpact MTZ3	MTZ3 40 H1/H2 MTZ3 50 H1/H2					
Type of Canalis busbar trunking KTA4000 / KTC4000 reinforced short-circuit level							
Isc max. in kA rms		42 kA	50 kA	65 kA	90 kA	100 kA	120 kA
Type of circuit breaker	Masterpact MTZ2	MTZ2 32 H1/H2/H3 MTZ2 40 H1/H2/H3			MTZ2 32 H2/H3 MTZ2 40 H2/H3		MTZ2 32 H3 MTZ2 40 H3
	Masterpact MTZ3	MTZ3 40 H1/H2 MTZ3 50 H1/H2			MTZ3 40 H2 MTZ3 50 H2		
Type of Canalis busbar trunking KTC5000							
Isc max. in kA rms		42 kA	50 kA	65 kA	95 kA	100 kA	110 kA
Type of circuit breaker	Masterpact MTZ2	MTZ2 32 H1/H2/H3 MTZ2 40 H1/H2/H3			MTZ2 32 H2/H3 MTZ2 40 H2/H3		
	Masterpact MTZ3	MTZ3 40 H1/H2 MTZ3 50 H1/H2 MTZ3 63 H1/H2					
Type of Canalis busbar trunking KTC5000 reinforced short-circuit level							
Isc max. in kA rms		42 kA	50 kA	65 kA	90 kA	100 kA	120 kA
Type of circuit breaker	Masterpact MTZ2	MTZ2 32 H1/H2/H3 MTZ2 40 H1/H2/H3			MTZ2 32 H2/H3 MTZ2 40 H2/H3		MTZ2 32 H3 MTZ2 40 H3
	Masterpact MTZ3	MTZ3 40 H1/H2 MTZ3 50 H1/H2 MTZ3 63 H1/H2			MTZ3 40 H2 MTZ3 50 H2 MTZ3 63 H2		

[1] L1 up to 150kA.

# Coordination tables between circuit breaker and Canalis electrical busbar trunking

Canalis KRA  
Ue: 380-415 V AC

Type of Canalis busbar trunking KRA0800							
Isc max. in kA rms		≤ 25 kA	50 kA	60 kA	70 kA	100 kA	150 kA
Type of circuit breaker	Compact NSX	NSX400B/F/N/H/S/L NSX630B/F/N/H/S/L	NSX400N/H/S/L NSX630N/H/S/L		NSX400H/S/L NSX630H/S/L	NSX400S/L NSX630S/L	NSX400L NSX630L
	Compact NS	NS630b N/H/L/LB <b>NS800N/H/L/LB</b> NS1000N/H/L		NS630b L/LB <b>NS800L/LB</b> NS1000L		NS630b LB NS800LB	
	Masterpact MTZ1	MTZ1 06 H1/H2/H3/L1 <b>MTZ1 08 H1/H2/H3/L1</b> MTZ1 10 H1/H2/H3/L1		MTZ1 06 L1 <b>MTZ1 08 L1</b> MTZ1 10 L1			
	Masterpact MTZ2	MTZ2 08 N1/H1/H2/L1 MTZ2 10 N1/H1/H2/L1					
Type of Canalis busbar trunking KRA1000							
Isc max. in kA rms		≤ 25 kA	50 kA	60 kA	70 kA	100 kA	150 kA
Type of circuit breaker	Compact NSX	NSX400B/F/N/H/S/L NSX630B/F/N/H/S/L	NSX400N/H/S/L NSX630N/H/S/L		NSX400H/S/L NSX630H/S/L	NSX400S/L NSX630S/L	NSX400L NSX630L
	Compact NS	NS800N/H/L/LB <b>NS1000N/H/L</b> NS1250N/H		NS800L/LB <b>NS1000L</b>		NS800LB	
	Masterpact MTZ1	MTZ1 08 H1/H2/H3/L1 <b>MTZ1 10 H1/H2/H3/L1</b> MTZ1 12 H1/H2/H3		MTZ1 08 L1 <b>MTZ1 10 L1</b>			
	Masterpact MTZ2	MTZ2 08 N1/H1/H2/L1 <b>MTZ2 10 N1/H1/H2/L1</b> MTZ2 12 N1/H1/H2/L1					
Type of Canalis busbar trunking KRA1250							
Isc max. in kA rms		≤ 42 kA	50 kA	60 kA	70 kA	100 kA	150 kA
Type of circuit breaker	Compact NSX	NSX630B/F/N/H/S/L	NSX630N/H/S/L	NSX630H/S/L		NSX630S/L	NSX630L
	Compact NS	NS1000N/H/L <b>NS1250N/H</b> NS1600N/H				NS1000L	
	Masterpact MTZ1	MTZ1 10H1/H2/H3/L1 <b>MTZ1 12H1/H2/H3</b> MTZ1 16H1/H2/H3	MTZ1 10 H2/H3/L1 <b>MTZ1 12 H2/H3</b> MTZ1 16 H2/H3			MTZ1 10 L1	
	Masterpact MTZ2	MTZ2 10 N1/H1/H2/L1 <b>MTZ2 12 N1/H1/H2/L1</b> MTZ2 16 N1/H1/H2/L1	MTZ2 10 H1/H2/L1 <b>MTZ2 12 H1/H2/L1</b> MTZ2 16 H1/H2/L1	MTZ2 10 L1 <b>MTZ2 12 L1</b> MTZ2 16 L1			
Type of Canalis busbar trunking KRA1600							
Isc max. in kA rms		42 kA	50 kA	60 kA	70 kA	100 kA	150 kA
Type of circuit breaker	Compact NS ≤ 1600	NS1250N/H <b>NS1600N/H</b>					
	Compact NS ≥ 1600b	<b>NS1600b N/H</b> NS2000N/H					
	Masterpact MTZ1	MTZ1 12 H1/H2/H3 <b>MTZ1 16 H1/H2/H3</b>	MTZ1 12 H2/H3 <b>MTZ1 16 H2/H3</b>				
	Masterpact MTZ2	MTZ2 10 N1/H1/H2/L1 MTZ2 12 N1/H1/H2/L1 <b>MTZ2 16 N1/H1/H2/L1</b>	MTZ2 10 H1/H2/L1 MTZ2 12 H1/H2/L1 <b>MTZ2 16 H1/H2/L1</b>	MTZ2 10 L1 MTZ2 12 L1 <b>MTZ2 16 L1</b>			
Type of Canalis busbar trunking KRA2000							
Isc max. in kA rms		42 kA	50 kA	65 kA	85 kA	100 kA	150 kA
Type of circuit breaker	Compact NS ≤ 1600		NS1600N/H	NS1600H			
	Compact NS ≥ 1600b		NS1600b N/H <b>NS2000N/H</b> NS2500N/H				
	Masterpact MTZ1	MTZ1 16 H1/H2/H3	MTZ1 16 H2/H3	MTZ1 16 H3			
	Masterpact MTZ2	MTZ2 16 N1/H1/H2/L1 <b>MTZ2 20 N1</b> MTZ2 25 H1/H2/H3	MTZ2 16 H1/H2/L1 <b>MTZ2 20 H1/H2/L1</b> MTZ2 25 H1/H2/H3	MTZ2 16 L1 <b>MTZ2 20 L1</b>			
Type of Canalis busbar trunking KRA2500							
Isc max. in kA rms		42 kA	50 kA	65 kA	80 kA	100 kA	150 kA
Type of circuit breaker	Compact NS ≥ 1600b		NS2000N/H <b>NS2500N/H</b> NS3200N/H		NS2000H <b>NS2500H</b> NS3200H		
	Masterpact MTZ2	MTZ2 20 N1	MTZ2 20 H1/H2/H3/L1		MTZ2 20 H1/H2/H3/L1 <b>MTZ2 25 H2/H3</b> MTZ2 32 H2/H3		MTZ2 20 L1
Type of Canalis busbar trunking KRA3200							
Isc max. in kA rms		42 kA	50 kA	65 kA	85 kA	100 kA	150 kA
Type of circuit breaker	Compact NS ≥ 1600b		NS2500N/H <b>NS3200N/H</b>		NS2500H <b>NS3200H</b>		
	Masterpact MTZ2		MTZ2 25 H1/H2/H3 <b>MTZ2 32 H1/H2/H3</b> MTZ2 40 H1/H2/H3		MTZ2 25 H2/H3 <b>MTZ2 32 H2/H3</b> MTZ2 40 H2/H3		
	Masterpact MTZ3			MTZ3 40 H1/H2			
Type of Canalis busbar trunking KRA4000							
Isc max. in kA rms		42 kA	50 kA	65 kA	85 kA	100 kA	150 kA
Type of circuit breaker	Compact NS		NS3200N/H		NS3200H		
	Masterpact MTZ2		MTZ2 32 H1/H2/H3 <b>MTZ2 40 H1/H2/H3</b>		MTZ2 32 H2/H3 <b>MTZ2 40 H2/H3</b>		
	Masterpact MTZ3			MTZ3 40 H1/H2 MTZ3 50 H1/H2			
Type of Canalis busbar trunking KRA5000							
Isc max. in kA rms		42 kA	50 kA	65 kA	85 kA	100 kA	150 kA
Type of circuit breaker	Masterpact MTZ2		MTZ2 40 H1/H2/H3		MTZ2 40 H2/H3		
	Masterpact MTZ3			MTZ3 40 H1/H2 <b>MTZ3 50 H1/H2</b> MTZ3 63 H1/H2			



# Coordination tables between circuit breaker and Canalis electrical busbar trunking

Canalis KRC  
Ue: 380-415 V AC

Type of Canalis busbar trunking KRC1000							
Isc max. in kA rms		≤ 36 kA	50 kA	60 kA	70 kA	100 kA	150 kA
Type of circuit breaker	Compact NSX	NSX400B/F/N/H/S/L NSX630B/F/N/H/S/L	NSX400N/H/S/L NSX630N/H/S/L		NSX400H/S/L NSX630H/S/L	NSX400S/L NSX630S/L	NSX400L NSX630L
	Compact NS	NS800N/H/L/LB NS1000N/H/L NS1250N/H			NS800L/LB NS1000L		
	Masterpact MTZ1	MTZ1 08 H1/H2/H3/L1 MTZ1 10 H1/H2/H3/L1 MTZ1 12 H1/H2/H3			MTZ1 08 L1 MTZ1 10 L1		
	Masterpact MTZ2	MTZ2 08 N1/H1/H2/L1 MTZ2 10 N1/H1/H2/L1 MTZ2 12 N1/H1/H2/L1					
Type of Canalis busbar trunking KRC1350							
Isc max. in kA rms		≤ 36 kA	50 kA	60 kA	70 kA	100 kA	150 kA
Type of circuit breaker	Compact NSX	NSX630B/F/N/H/S/L	NSX630N/H/S/L	NSX630H/S/L		NSX630S/L	NSX630L
	Compact NS	NS1000N/H/L NS1250N/H NS1600N/H				NS1000L	
	Masterpact MTZ1	MTZ1 10 H1/H2/H3/L1 MTZ1 12 H1/H2/H3 MTZ1 16 H1/H2/H3				MTZ1 10 L1	
	Masterpact MTZ2	MTZ2 10 N1/H1/H2/L1 MTZ2 12 N1/H1/H2/L1 MTZ2 16 N1/H1/H2/L1					
Type of Canalis busbar trunking KRC1600							
Isc max. in kA rms		42 kA	50 kA	65 kA	85 kA	100 kA	150 kA
Type of circuit breaker	Compact NS ≤ 1600		NS1250N/H NS1600N/H	NS1250H NS1600H			
	Compact NS ≥ 1600b		NS1600b N/H NS2000N/H				
	Masterpact MTZ1	MTZ1 12 H1 MTZ1 16 H1	MTZ1 12 H2 MTZ1 16 H2	MTZ1 12 H3 MTZ1 16 H3			
	Masterpact MTZ2	MTZ2 12 N1 MTZ2 16 N1 MTZ2 20 N1		MTZ2 12 H1 MTZ2 16 H1 MTZ2 20 H1	MTZ2 12 L1 MTZ2 16 L1 MTZ2 20 L1		
Type of Canalis busbar trunking KRC2000							
Isc max. in kA rms		42 kA	50 kA	65 kA	80 kA	100 kA	150 kA
Type of circuit breaker	Compact NS ≤ 1600		NS1600N/H	NS1600H			
	Compact NS ≥ 1600b		NS1600b N NS2000N NS2500N		NS1600b H NS2000H NS2500H		
	Masterpact MTZ1	MTZ1 16 H1/H2/H3	MTZ1 16 H2/H3	MTZ1 16 H3			
	Masterpact MTZ2	MTZ2 16 N1/H1/H2/L1 MTZ2 20 N1/H1/H2/H3/L1 MTZ2 25 H1/H2/H3	MTZ2 16 H1/H2/L1 MTZ2 20 H1/H2/H3/L1 MTZ2 25 H1/H2/H3	MTZ2 16 H1/H2/L1 MTZ2 20 H1/H2/H3/L1 MTZ2 25 H1/H2/H3	MTZ2 16 H2/L1 MTZ2 20 H2/H3/L1 MTZ2 25 H2/H3		MTZ2 16 L1 MTZ2 20 L1
Type of Canalis busbar trunking KRC2500							
Isc max. in kA rms		42 kA	50 kA	65 kA	80 kA	100 kA	150 kA
Type of circuit breaker	Compact NS ≥ 1600b		NS2000N/H NS2500N/H NS3200N/H		NS2000H NS2500H NS3200H		
	Masterpact MTZ2	MTZ2 20 N1	MTZ2 20 H1/H2/H3/L1 MTZ2 25 H1/H2/H3 MTZ2 32 H1/H2/H3	MTZ2 20 H1/H2/H3/L1 MTZ2 25 H1/H2/H3 MTZ2 32 H1/H2/H3	MTZ2 20 H2/H3/L1 MTZ2 25 H2/H3 MTZ2 32 H2/H3		MTZ2 20 L1
Type of Canalis busbar trunking KRC3200							
Isc max. in kA rms		42 kA	50 kA	65 kA	85 kA	100 kA	150 kA
Type of circuit breaker	Compact NS ≥ 1600b		NS2500N/H NS3200N/H		NS2500H NS3200H		
	Masterpact MTZ2		MTZ2 25 H1/H2/H3 MTZ2 32 H1/H2/H3 MTZ2 40 H1/H2/H3		MTZ2 25 H2/H3 MTZ2 32 H2/H3 MTZ2 40 H2/H3		
	Masterpact MTZ3			MTZ3 40 H1/H2			
Type of Canalis busbar trunking KRC4000							
Isc max. in kA rms		42 kA	50 kA	65 kA	85 kA	100 kA	150 kA
Type of circuit breaker	Compact NS		NS3200N/H		NS3200H		
	Masterpact MTZ2		MTZ2 32 H1/H2/H3 MTZ2 40 H1/H2/H3		MTZ2 32 H2/H3 MTZ2 40 H2/H3		
	Masterpact MTZ3			MTZ3 40 H1/H2 MTZ3 50 H1/H2			
Type of Canalis busbar trunking KRC5000							
Isc max. in kA rms		42 kA	50 kA	65 kA	85 kA	100 kA	125 kA
Type of circuit breaker	Masterpact MTZ2		MTZ2 40 H1/H2/H3		MTZ2 40 H2/H3		MTZ2 40 H3
	Masterpact MTZ3			MTZ3 40 H1/H2 MTZ3 50 H1/H2 MTZ3 63 H1/H2			MTZ3 40 H2 MTZ3 50 H2 MTZ3 63 H2
Type of Canalis busbar trunking KRC6300							
Isc max. in kA rms		42 kA	50 kA	65 kA	85 kA	100 kA	125 kA
Type of circuit breaker	Masterpact MTZ2		MTZ2 40 H1/H2/H3		MTZ2 40 H2/H3		MTZ2 40H3
	Masterpact MTZ3			MTZ3 40 H1/H2 MTZ3 50 H1/H2 MTZ3 63 H1/H2			MTZ3 40H2 MTZ3 50H2 MTZ3 63H2



# Coordination tables between circuit breaker and Canalis electrical busbar trunking

Canalis KSA  
Ue: 660-690 V AC

Type of Canalis busbar trunking KSA100								
Isc max. in kA rms		10 kA	15 kA	20 kA	25 kA	45 kA	75 kA	100 kA
Type of circuit breaker	Compact NSX	NSX100N/H/S/L NSX160N/H/S/L NSX250N/H/S/L	NSX100S/L NSX160S/L NSX250S/L	NSX100L				
Type of Canalis busbar trunking KSA160								
Isc max. in kA rms		10 kA	15 kA	20 kA	25 kA	45 kA	75 kA	100 kA
Type of circuit breaker	Compact NSX	NSX100N/H/S/L NSX160N/H/S/L NSX250N/H/S/L	NSX100S/L NSX160S/L NSX250S/L	NSX100L NSX160L NSX250L	NSX100R			
Type of Canalis busbar trunking KSA250								
Isc max. in kA rms		10 kA	15 kA	20 kA	25 kA	45kA	75 kA	100 kA
Type of circuit breaker	Compact NSX	NSX160N/H/S/L NSX250N/H/S/L NSX400F/N/H/S/L	NSX160S/L NSX250S/L NSX400H/S/L	NSX160L NSX250L NSX400H/S/L		NSX250R	NSX250HB1	NSX250HB2
Type of Canalis busbar trunking KSA400								
Isc max. in kA rms		10 kA	15 kA	20 kA	25 kA	45kA	75 kA	100 kA
Type of circuit breaker	Compact NSX	NSX250N/H/S/L	NSX250S/L	NSX250L	NSX250R		NSX250HB1	NSX250HB2
		NSX400F/N/H/S/L		NSX400H/S/L	NSX400S/L	NSX400R	NSX400HB1	NSX400HB2
		NSX630F/N/H/S/L		NSX630H/S/L	NSX630S/L	NSX630R		
	Compact NS	NS630b N/H/LB			NS630b LB			
Type of Canalis busbar trunking KSA500								
Isc max. in kA rms		10 kA	15 kA	20 kA	25 kA	45 kA	75 kA	100 kA
Type of circuit breaker	Compact NSX	NSX400F/N/H/S/L		NSX400H/S/L	NSX400S/L	NSX400R	NSX400HB1	NSX400HB2
		NSX400F/N/H/S/L		NSX630H/S/L	NSX630S/L	NSX630R	NSX630HB1	NSX630HB2
	Compact NS	NS630b N/H/LB NS800N/H/LB				NS630b LB NS800LB		
Type of Canalis busbar trunking KSA630								
Isc max. in kA rms		10 kA	15 kA	20 kA	25 kA	45 kA	75 kA	100 kA
Type of circuit breaker	Compact NSX	NSX400F/N/H/S/L	NSX400H/S/L	NSX400H/S/L	NSX400S/L	NSX400R	NSX400HB1	NSX400HB2
		NSX630F/N/H/S/L	NSX630H/S/L	NSX630H/S/L	NSX630S/L	NSX630R	NSX630HB1	NSX630HB2
	Compact NS	NS630b N/H/LB NS800N/H/LB				NS630b LB NS800LB		
Type of Canalis busbar trunking KSA800								
Isc max. in kA rms		25 kA	30 kA	35 kA	45 kA	65 kA	75 kA	100 kA
Type of circuit breaker	Compact NSX	NSX400S/L/R/HB1/HB2 NSX630S/L/R/HB1/HB2	NSX400L/R/HB1/HB2 NSX630L/R/HB1/HB2	NSX400R/HB1/HB2 NSX630R/HB1/HB2		NSX400HB1/HB2 NSX630HB1/HB2		NSX400HB2 NSX630HB2
	Compact NS	NS630b N/H/LB NS800N/H/LB NS1000N/H		NS630b H/LB NS800H/LB NS1000H	NS630b LB NS800LB			
	Masterpact MTZ1	MTZ1 06 H1/H2/L1 MTZ1 08 H1/H2/L1 MTZ1 10 H1/H2/L1	MTZ1 06 H1/H2 MTZ1 08 H1/H2 MTZ1 10 H1/H2					
	Masterpact MTZ2	MTZ2 08 N1/H1/H2/L1 MTZ2 10 N1/H1/H2/L1						
Type of Canalis busbar trunking KSA1000								
Isc max. in kA rms		25 kA	30 kA	35 kA	45 kA	65 kA	75 kA	100 kA
Type of circuit breaker	Compact NSX	NSX400S/L/R/HB1/HB2 NSX630S/L/R/HB1/HB2	NSX400L/R/HB1/HB2 NSX630L/R/HB1/HB2	NSX400R/HB1/HB2 NSX630R/HB1/HB2		NSX400HB1/HB2 NSX630HB1/HB2		NSX400HB2 NSX630HB2
	Compact NS	NS630b N/H/LB NS800N/H/LB NS1000N/H		NS630b H/LB NS800H/LB NS1000H	NS630b LB NS800LB			
	Masterpact MTZ1	MTZ1 08 H1/H2/L1 MTZ1 10 H1/H2/L1	MTZ1 08 H1/H2 MTZ1 10 H1/H2					
	Masterpact MTZ2	MTZ1 12 H1/H2 MTZ2 08 N1/H1/H2/L1 MTZ2 10 N1/H1/H2/L1 MTZ2 12 N1/H1/H2/L1						



# Coordination tables between circuit breaker and Canalis electrical busbar trunking

Canalis KTA, KTC  
Ue: 660-690 V AC

Type of Canalis busbar trunking KTA1000 / KTC1000								
Isc max. in kA rms		25 kA	30 kA	42 kA	50 kA	65 kA	75 kA	100 kA
Type of circuit breaker	Compact NSX	NSX400S/L/R/HB1/HB2 NSX630S/L/R/HB1/HB2	NSX400L/R/HB1/HB2 NSX630L/R/HB1/HB2	NSX400R/HB1/HB2 NSX630R/HB1/HB2		NSX400HB1/HB2 NSX630HB1/HB2		NSX400HB2 NSX630HB2
	Compact NS	NS630b N/H/LB NS800N/H/LB NS1000N/H		NS630b H/LB NS800H/LB NS1000H		NS630b LB NS800LB		
	Masterpact MTZ1	MTZ1 08 H1/H2/L1 MTZ1 10 H1/H2/L1	MTZ1 08 H1/H2 MTZ1 10 H1/H2					
	Masterpact MTZ2	MTZ1 12 H1/H2		MTZ2 08 H1/H2/L1 MTZ2 10 N1/H1/H2/L1 MTZ2 12 N1/H1/H2/L1		MTZ2 08 H1/H2/L1 MTZ2 10 H1/H2/L1 MTZ2 12 H1/H2/L1		
Type of Canalis busbar trunking KTA1000 / KTC1000 reinforced short-circuit level								
Isc max. in kA rms		25 kA	30 kA	42 kA	50 kA	65 kA	75 kA	100 kA
Type of circuit breaker	Compact NSX	NSX400S/L/R/HB1/HB2 NSX630S/L/R/HB1/HB2	NSX400L/R/HB1/HB2 NSX630L/R/HB1/HB2	NSX400R/HB1/HB2 NSX630R/HB1/HB2		NSX400HB1/HB2 NSX630HB1/HB2		NSX400HB2 NSX630HB2
	Compact NS	NS800N/H/LB NS1000N/H NS1250N/H		NS800H/LB NS1000H NS1250H		NS800LB		
	Masterpact MTZ1	MTZ1 08 H1/H2/L1 MTZ1 10 H1/H2/L1	MTZ1 08 H1/H2 MTZ1 10 H1/H2					
	Masterpact MTZ2	MTZ1 12 H1/H2		MTZ2 08 N1/H1/H2/L1 MTZ2 10 N1/H1/H2/L1 MTZ2 12 N1/H1/H2/L1		MTZ2 08 H1/H2/L1 MTZ2 10 H1/H2/L1 MTZ2 12 H1/H2/L1		MTZ2 08 HL1 MTZ2 10 L1 MTZ2 12 L1
Type of Canalis busbar trunking KTA1250 / KTC1350								
Isc max. in kA rms		25 kA	30 kA	42 kA	50 kA	65 kA	75 kA	100 kA
Type of circuit breaker	Compact NS	NS800N/H/LB NS1000N/H NS1250N/H NS1600N/H		NS800H/LB NS1000H NS1250H NS1600H		NS800LB		
	Compact NS > 1600b	NS1600b N						
	Masterpact MTZ1	MTZ1 08 H1/H2/L1	MTZ1 08 H1/H2					
	Masterpact MTZ2	MTZ1 12 H1/H2 MTZ1 16 H1/H2		MTZ2 10 N1/H1/H2/L1 MTZ2 12 N1/H1/H2/L1 MTZ2 16 N1/H1/H2/L1		MTZ2 10 H1/H2/L1 MTZ2 12 H1/H2/L1 MTZ2 16 H1/H2/L1		MTZ2 10 L1 MTZ2 12 L1 MTZ2 16 L1
Type of Canalis busbar trunking KTA1250 / KTC1350 reinforced short-circuit level								
Isc max. in kA rms		25 kA	30 kA	42 kA	50 kA	65 kA	75 kA	100 kA
Type of circuit breaker	Compact NS	NS800N/H/LB NS1000N/H NS1250N/H NS1600N/H		NS800H/LB NS1000H NS1250H NS1600H		NS800LB		
	Compact NS > 1600b	NS1600b N						
	Masterpact MTZ1	MTZ1 08 H1/H2/L1	MTZ1 08 H1/H2					
	Masterpact MTZ2	MTZ1 12 H1/H2 MTZ1 16 H1/H2		MTZ2 10 N1/H1/H2/L1 MTZ2 12 N1/H1/H2/L1 MTZ2 16 N1/H1/H2/L1		MTZ2 10 H1/H2/L1 MTZ2 12 H1/H2/L1 MTZ2 16 H1/H2/L1		MTZ2 10 L1 MTZ2 12 L1 MTZ2 16 L1
Type of Canalis busbar trunking KTA1600 / KTC1600								
Isc max. in kA rms		25 kA	30 kA	42 kA	50 kA	65 kA	85 kA	100 kA
Type of circuit breaker	Compact NS	NS1250N/H NS1600N/H		NS1250H NS1600H				
	Compact NS > 1600b	NS1600b N NS2000N						
	Masterpact MTZ1	MTZ1 12 H1/H2 MTZ1 16 H1/H2		MTZ2 12 N1/H1/H2/L1 MTZ2 16 N1/H1/H2/L1 MTZ2 20 N1/H1/H2/H3/L1		MTZ2 12 H1/H2/L1 MTZ2 16 H1/H2/L1 MTZ2 20 H1/H2/H3/L1		MTZ2 12 L1 MTZ2 16 L1 MTZ2 20 L1
Type of Canalis busbar trunking KTA1600 / KTC1600 reinforced short-circuit level								
Isc max. in kA rms		25 kA	30 kA	42 kA	50 kA	65 kA	85 kA	100 kA
Type of circuit breaker	Compact NS	NS1250N/H NS1600N/H		NS1250H NS1600H				
	Compact NS > 1600b	NS1600b N NS2000N						
	Masterpact MTZ1	MTZ1 12 H1/H2 MTZ1 16 H1/H2		MTZ2 12 N1/H1/H2/L1 MTZ2 16 N1/H1/H2/L1 MTZ2 20 N1/H1/H2/H3/L1		MTZ2 12 H1/H2/L1 MTZ2 16 H1/H2/L1 MTZ2 20 H1/H2/H3/L1		MTZ2 12 L1 MTZ2 16 L1 MTZ2 20 L1

E

# Coordination tables between circuit breaker and Canalis electrical busbar trunking

Canalis KTA, KTC  
Ue: 660-690 V AC

Type of Canalis busbar trunking KTA2000 / KTC2000									
Isc max. in kA rms		25 kA	30 kA	42 kA	50 kA	65 kA	85 kA	100 kA	
Type of circuit breaker	Compact NS	NS1600N/H		NS1600H					
	Compact NS > 1600b			NS1600b N NS2000N NS2500N					
	Masterpact MTZ1	MTZ1 16 H1/H2							
	Masterpact MTZ2	MTZ2 16 N1/H1/H2/L1 MTZ2 20 N1/H1/H2/H3/L1		MTZ2 16 H1/H2/L1 MTZ2 20 H1/H2/H3/L1			MTZ2 16 L1 MTZ2 20 L1		
		MTZ2 25 H1/H2/H3							
Type of Canalis busbar trunking KTA2000 / KTC2000 reinforced short-circuit level									
Isc max. in kA rms		25 kA	30 kA	42 kA	50 kA	65 kA	85 kA	100 kA	
Type of circuit breaker	Compact NS	NS1600N/H		NS1600H					
	Compact NS > 1600b			NS1600b N NS2000N NS2500N					
	Masterpact MTZ1	MTZ1 16 H1/H2							
	Masterpact MTZ2	MTZ2 16 N1/H1/H2/L1 MTZ2 20 N1/H1/H2/H3/L1		MTZ2 16 H1/H2/L1 MTZ2 20 H1/H2/H3/L1	MTZ2 16L1 MTZ2 20 H2/H3/L1	MTZ2 25 H2/H3	MTZ2 16 L1 MTZ2 20 H3/L1		
		MTZ2 25 H1/H2/H3							
Type of Canalis busbar trunking KTA2500 / KTC2500									
Isc max. in kA rms		25 kA	30 kA	42 kA	50 kA	65 kA	80 kA	100 kA	
Type of circuit breaker	Compact NS	NS1600N/H		NS1600H					
	Compact NS > 1600b			NS2000N NS2500N NS3200N					
	Masterpact MTZ1	MTZ1 16 H1/H2							
	Masterpact MTZ2	MTZ2 20 N1/H1/H2/H3/L1		MTZ2 20 H1/H2/H3/L1	MTZ2 20 H2/H3/L1 MTZ2 25 H2/H3	MTZ2 32 H2/H3	MTZ2 20 L1		
		MTZ2 25 H1/H2/H3							
		MTZ2 32 H1/H2/H3							
Type of Canalis busbar trunking KTA2500 / KTC2500 reinforced short-circuit level									
Isc max. in kA rms		25 kA	30 kA	42 kA	50 kA	65 kA	85 kA	100 kA	
Type of circuit breaker	Compact NS	NS1600N/H		NS1600H					
	Compact NS > 1600b			NS2000N NS2500N NS3200N					
	Masterpact MTZ1	MTZ1 16 H1/H2							
	Masterpact MTZ2	MTZ2 20 N1/H1/H2/H3/L1		MTZ2 20 H1/H2/H3/L1	MTZ2 20 H2/H3/L1 MTZ2 25 H2/H3	MTZ2 32 H2/H3	MTZ2 20 H3/L1		
		MTZ2 25 H1/H2/H3							
		MTZ2 32 H1/H2/H3							
Type of Canalis busbar trunking KTA3200 / KTC3200									
Isc max. in kA rms		25 kA	30 kA	42 kA	50 kA	65 kA	85 kA	100 kA	
Type of circuit breaker	Compact NS > 1600b			NS2000N NS3200N					
	Masterpact MTZ2			MTZ2 32 H1/H2/H3 MTZ2 40 H1/H2/H3			MTZ2 32 H2/H3 MTZ2 40 H2/H3		
	Masterpact MTZ3	MTZ3 40 H1/H2							
Type of Canalis busbar trunking KTA3200 / KTC3200 reinforced short-circuit level									
Isc max. in kA rms		25 kA	30 kA	42 kA	50 kA	65 kA	85 kA	100 kA	
Type of circuit breaker	Compact NS > 1600b			NS2000N NS3200N					
	Masterpact MTZ2			MTZ2 32 H1/H2/H3 MTZ2 40 H1/H2/H3			MTZ2 32 H2/H3 MTZ2 40 H2/H3	MTZ2 32 H3 MTZ2 40 H3	
	Masterpact MTZ3	MTZ3 40 H1/H2							
Type of Canalis busbar trunking KTA4000 / KTC4000									
Isc max. in kA rms		25 kA	30 kA	42 kA	50 kA	65 kA	85 kA	100 kA	
Type of circuit breaker	Compact NS > 1600b			NS3200N					
	Masterpact MTZ2			MTZ2 32 H1/H2/H3 MTZ2 40 H1/H2/H3			MTZ2 32 H2/H3 MTZ2 40 H2/H3		
	Masterpact MTZ3	MTZ3 40 H1/H2 MTZ3 50 H1/H2							
Type of Canalis busbar trunking KTA4000 / KTC4000 reinforced short-circuit level									
Isc max. in kA rms		25 kA	30 kA	42 kA	50 kA	65 kA	85 kA	95 kA	100 kA
Type of circuit breaker	Compact NS			NS3200N					
	Masterpact MTZ2			MTZ2 32 H1/H2/H3 MTZ2 40 H1/H2/H3			MTZ2 32 H2/H3 MTZ2 40 H2/H3	MTZ2 32 H3 MTZ2 40 H3	
	Masterpact MTZ3	MTZ3 40 H1/H2 MTZ3 50 H1/H2 MTZ3 63 H1/H2							



# Coordination tables between circuit breaker and Canalis electrical busbar trunking

Canalis KRA  
Ue: 660-690 V AC

Type of Canalis busbar trunking KRA0800								
Isc max. in kA rms	25 kA	30 kA	36 kA	45 kA	65 kA	75 kA	100 kA	
Type of circuit breaker	Compact NSX	NSX400S/L/R/HB1/HB2 NSX630S/L/R/HB1/HB2	NSX400L/R/HB1/HB2 NSX630L/R/HB1/HB2	NSX400R/HB1/HB2 NSX630R/HB1/HB2		NSX400HB1/HB2 NSX630HB1/HB2	NSX400HB2 NSX630HB2	
	Compact NS	NS630b N/H/LB NS800N/H/LB NS1000N/H			NS630b LB NS800LB			
	Masterpact MTZ1	MTZ1 06 H1/H2/L1 MTZ1 08 H1/H2/L1 MTZ1 10 H1/H2/L1						
	Masterpact MTZ2	MTZ2 08N1/H1/H2/L1 MTZ2 10N1/H1/H2/L1						
Type of Canalis busbar trunking KRA1000								
Isc max. in kA rms	25 kA	30 kA	36 kA	45 kA	65 kA	75 kA	100 kA	
Type of circuit breaker	Compact NSX	NSX400S/L/R/HB1/HB2 NSX630S/L/R/HB1/HB2	NSX400L/R/HB1/HB2 NSX630L/R/HB1/HB2	NSX400R/HB1/HB2 NSX630R/HB1/HB2		NSX400HB1/HB2 NSX630HB1/HB2	NSX400HB2 NSX630HB2	
	Compact NS	NS800N/H/LB NS1000N/H NS1250N/H			NS800LB			
	Masterpact MTZ1	MTZ1 08 H1/H2/L1 MTZ1 10 H1/H2/L1 MTZ1 12 H1/H2						
	Masterpact MTZ2	MTZ2 08 N1/H1/H2/L1 MTZ2 10 N1/H1/H2/L1 MTZ2 12 N1/H1/H2/L1						
Type of Canalis busbar trunking KRA1250								
Isc max. in kA rms	25 kA	30 kA	35 kA	42 kA	50 kA	75 kA	100 kA	
Type of circuit breaker	Compact NSX	NSX630H/S/L	NSX630S/L/R/HB1/HB2	NSX630L/R/HB1/HB2	NSX630R/HB1/HB2	NSX630HB1/HB2	NSX630HB2	
	Compact NS	NS1000N/H NS1250N/H NS1600N/H		NS1000H NS1250H NS1600H		NS800LB		
	Masterpact MTZ1	MTZ1 10 H1/H2/L1		MTZ1 10 H1/H2				
	Masterpact MTZ2		MTZ1 12 H1/H2 MTZ1 16 H1/H2					
			MTZ2 10 N1/H1/H2/L1 MTZ2 12 N1/H1/H2/L1 MTZ2 16 N1/H1/H2/L1		MTZ2 10 H1/H2/L1 MTZ2 12 H1/H2/L1 MTZ2 16 H1/H2/L1			
Type of Canalis busbar trunking KRA1600								
Isc max. in kA rms	25 kA	30 kA	42 kA	50 kA	65 kA	75 kA	100 kA	
Type of circuit breaker	Compact NS	NS1250N/H NS1600N/H	NS1250H NS1600H					
	Compact NS ≥ 1600b		NS1600b N NS2000N					
	Masterpact MTZ1		MTZ1 12 H1/H2 MTZ1 16 H1/H2					
	Masterpact MTZ2		MTZ2 12 N1/H1/H2/L1 MTZ2 16 N1/H1/H2/L1 MTZ2 20 N1/H1/H2/H3/L1		MTZ2 12 H1/H2/L1 MTZ2 16 H1/H2/L1 MTZ2 20 H1/H2/H3/L1			
Type of Canalis busbar trunking KRA2000								
Isc max. in kA rms	25 kA	30 kA	42 kA	50 kA	65 kA	80 kA	100 kA	
Type of circuit breaker	Compact NS	NS1600N/H	NS1600H					
	Compact NS ≥ 1600b		NS1600b N NS2000N NS2500N					
	Masterpact MTZ1		MTZ1 16 H1/H2					
	Masterpact MTZ2		MTZ2 16 N1/H1/H2/L1 MTZ2 20 N1/H1/H2/H3/L1 MTZ2 25 H1/H2/H3		MTZ2 16 H1/H2/L1 MTZ2 20 H1/H2/H3/L1 MTZ2 25 H1/H2/H3	MTZ2 16 L1 MTZ2 20 L1		
Type of Canalis busbar trunking KRA2500								
Isc max. in kA rms	25 kA	30 kA	42 kA	50 kA	65 kA	80 kA	100 kA	
Type of circuit breaker	Compact NS ≥ 1600b		NS2000N NS2500N NS3200N					
	Masterpact MTZ2		MTZ2 20 N1/H1/H2/H3/L1		MTZ2 20 H1/H2/H3/L1	MTZ2 20 H2/H3 MTZ2 20 L1		
			MTZ2 25 H1/H2/H3 MTZ2 32 H1/H2/H3			MTZ2 25 H2/H3 MTZ2 32 H2/H3		
Type of Canalis busbar trunking KRA3200								
Isc max. in kA rms	25 kA	30 kA	42 kA	50 kA	65 kA	85 kA	100 kA	
Type of circuit breaker	Compact NS > 1600b		NS2500N NS3200N					
	Masterpact MTZ2		MTZ2 25 H1/H2/H3 MTZ2 32 H1/H2/H3 MTZ2 40 H1/H2/H3			MTZ2 25 H2/H3 MTZ2 32 H2/H3 MTZ2 40 H2/H3	MTZ2 25 H3 MTZ2 32 H3 MTZ2 40 H3	
	Masterpact MTZ3				MTZ3 40 H1/H2			

E

# Coordination tables between circuit breaker and Canalis electrical busbar trunking

Canalis KRA, KRC  
Ue: 660-690 V AC

Type of Canalis busbar trunking KRA4000									
Isc max. in kA rms	25 kA	30 kA	42 kA	50 kA	65 kA	85 kA	100 kA		
Type of circuit breaker	Compact NS ≥ 1600b	NS3200N							
	Masterpact MTZ2	MTZ2 32 H1/H2/H3 MTZ2 40 H1/H2/H3				MTZ2 32 H2/H3 MTZ2 40 H2/H3	MTZ2 32 H3 MTZ2 40 H3		
	Masterpact MTZ3	MTZ3 40 H1/H2/H3 MTZ3 50 H1/H2							
Type of Canalis busbar trunking KRA5000									
Isc max. in kA rms	25 kA	30 kA	42 kA	50 kA	65 kA	85 kA	100 kA		
Type of circuit breaker	Masterpact MTZ1	MTZ2 32 H1/H2/H3 MTZ2 40 H1/H2/H3				MTZ2 32 H2/H3 MTZ2 40 H2/H3	MTZ2 32 H3 MTZ2 40 H3		
	Masterpact MTZ2	MTZ3 40 H1/H2 MTZ3 50 H1/H2 MTZ3 63 H1/H2							
Type of Canalis busbar trunking KRC1000									
Isc max. in kA rms	25 kA	30 kA	36 kA	45 kA	65 kA	75 kA	100 kA		
Type of circuit breaker	Compact NSX	NSX400S/L/R/HB1/HB2 NSX630S/L/R/HB1/HB2	NSX400S/L/R/HB1/HB2 NSX630S/L/R/HB1/HB2	NSX400R/HB1/HB2 NSX630R/HB1/HB2	NSX400HB1/HB2 NSX630HB1/HB2	NSX400HB2 NSX630HB2	NSX400HB2 NSX630HB2		
	Compact NS	NS800N/H/LB NS1000N/H NS1250N/H	NS800N/H/LB NS1000N/H NS1250N/H	NS800H/LB NS1000H NS1250H	NS800LB				
	Masterpact MTZ1	MTZ1 08 H1/H2/L1 MTZ1 10H1/H2/L1	MTZ1 08 H1/H2 MTZ1 10 H1/H2						
	Masterpact MTZ2	MTZ1 12 H1/H2							
		MTZ2 08 N1/H1/H2/L1 MTZ2 10 N1/H1/H2/L1 MTZ2 12 N1/H1/H2/L1							
Type of Canalis busbar trunking KRC1350									
Isc max. in kA rms	25 kA	30 kA	35 kA	45 kA	65 kA	75 kA	100 kA		
Type of circuit breaker	Compact NSX	NSX630H/S/L	NSX630S/L/R/HB1/HB2	NSX630L/R/HB1/HB2	NSX630R/HB1/HB2	NSX630HB1/HB2	NSX630HB2		
	Compact NS	NS1000N/H NS1250N/H NS1600N/H	NS1000H NS1250H NS1600H	NS800LB					
	Masterpact MTZ1	MTZ1 10 H1/H2/L1	MTZ1 10 H1/H2						
		MTZ1 12 H1/H2 MTZ1 16 H1/H2							
	Masterpact MTZ2	MTZ2 10 N1/H1/H2/L1 MTZ2 12 N1/H1/H2/L1 MTZ2 16 N1/H1/H2/L1							
Type of Canalis busbar trunking KRC1600									
Isc max. in kA rms	25 kA	30 kA	42 kA	50 kA	65 kA	75 kA	100 kA		
Type of circuit breaker	Compact NS	NS1250N/H NS1600N/H	NS1250H NS1600H						
	Compact NS ≥ 1600b	NS1600b N NS2000N							
	Masterpact MTZ1	MTZ1 12 H1/H2 MTZ1 16 H1/H2							
	Masterpact MTZ2	MTZ2 12 N1/H1/H2/L1 MTZ2 16 N1/H1/H2/L1 MTZ2 20 N1/H1/H2/H3/L1		MTZ2 12 H1/H2/L1 MTZ2 16 H1/H2/L1 MTZ2 20 H1/H2/H3/L1	MTZ2 12 L1 MTZ2 16 L1 MTZ2 20 L1				
Type of Canalis busbar trunking KRC2000									
Isc max. in kA rms	25 kA	30 kA	42 kA	50 kA	65 kA	80 kA	100 kA		
Type of circuit breaker	Compact NS	NS1600N/H	NS1600H						
	Compact NS ≥ 1600b	NS1600b N NS2000N NS2500N							
	Masterpact MTZ1	MTZ1 16 H1/H2							
	Masterpact MTZ2	MTZ2 16 N1/H1/H2/L1 MTZ2 20 N1/H1/H2/H3/L1 MTZ2 25 H1/H2/H3		MTZ2 16 H1/H2/L1 MTZ2 20 H1/H2/H3/L1 MTZ2 25 H1/H2/H3	MTZ2 16 H2/H3 MTZ2 20 H2/H3 MTZ2 25 H2/H3	MTZ2 16 L1 MTZ2 20 L1			
Type of Canalis busbar trunking KRC2500									
Isc max. in kA rms	25 kA	30 kA	42 kA	50 kA	65 kA	80 kA	100 kA		
Type of circuit breaker	Compact NS ≥ 1600b	NS2000N NS2500N NS3200N							
	Masterpact MTZ2	MTZ2 20 N1/H1/H2/H3/L1		MTZ2 20 H1/H2/H3/L1	MTZ2 20 H2/H3 MTZ2 25 H2/H3	MTZ2 20 L1			
		MTZ2 25 H1/H2/H3 MTZ2 32 H1/H2/H3							



# Coordination tables between circuit breaker and Canalis electrical busbar trunking

## Canalis KRC

U<sub>e</sub>: 660-690 V AC

Type of Canalis busbar trunking KRC3200									
Isc max. in kA rms		25 kA	30 kA	42 kA	50 kA	65 kA	85 kA	100 kA	
Type of circuit breaker	Compact NS ≥ 1600b	NS2500N NS3200N							
	Masterpact MTZ2	MTZ2 25 H1/H2/H3 MTZ2 32 H1/H2/H3 MTZ2 40 H1/H2/H3					MTZ2 25 H2/H3 MTZ2 32 H2/H3 MTZ2 40 H2/H3	MTZ2 25 H3 MTZ2 32 H3 MTZ2 40 H3	
	Masterpact MTZ3	MTZ3 40 H1/H2							
Type of Canalis busbar trunking KRC4000									
Isc max. in kA rms		25 kA	30 kA	42 kA	50 kA	65 kA	85 kA	100 kA	
Type of circuit breaker	Compact NS ≥ 1600b	NS3200N							
	Masterpact MTZ2	MTZ2 32 H1/H2/H3 MTZ2 40 H1/H2/H3					MTZ2 32 H2/H3 MTZ2 40 H2/H3	MTZ2 32 H3 MTZ2 40 H3	
	Masterpact MTZ3	MTZ3 40 H1/H2 MTZ3 50 H1/H2							
Type of Canalis busbar trunking KRC5000									
Isc max. in kA rms		25 kA	30 kA	42 kA	50 kA	65 kA	85 kA	100 kA	
Type of circuit breaker	Masterpact MTZ1	MTZ2 32 H1/H2/H3 MTZ2 40 H1/H2/H3					MTZ2 32 H2/H3 MTZ2 40 H2/H3	MTZ2 32 H3 MTZ2 40 H3	
	Masterpact MTZ2	MTZ3 40 H1/H2 MTZ3 50 H1/H2 MTZ3 63 H1/H2							
Type of Canalis busbar trunking KRC6300									
Isc max. in kA rms		25 kA	30 kA	42 kA	50 kA	65 kA	85 kA	100 kA	
Type of circuit breaker	Masterpact MTZ1	MTZ2 40 H1/H2/H3					MTZ2 40 H2/H3	MTZ2 40 H3	
	Masterpact MTZ2	MTZ3 40 H1/H2 MTZ3 50 H1/H2 MTZ3 63 H1/H2							



Life Is On | **Schneider**  
Electric

**Schneider Electric Industries SAS**

35, rue Joseph Monier  
CS 30323  
92506 Rueil Malmaison Cedex  
France

RCS Nanterre 954 503 439  
Capital social 896 313 776 €  
[www.schneider-electric.com](http://www.schneider-electric.com)

10-2018  
ART949617

© 2018 - Schneider Electric. All Rights Reserved.  
All trademarks are owned by Schneider Electric Industries SAS or its affiliated companies.  
Document reference: LVPED318033EN

This document has been  
printed on recycled paper

